

Built-in Sensors

General Catalog 2023

- Infrared Array Sensor / Grid-EYE
- Pressure Sensors

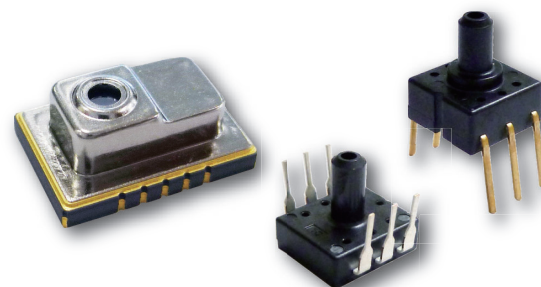

**IN Your
Innovation**

Safety and Legal Matters to Be Observed

Product specifications and applications

- Please be advised that this product and product specifications are subject to change without notice for improvement purposes. Therefore, please request and confirm the latest delivery specifications that explain the specifications in detail before the final design, or purchase or use of the product, regardless of the application. In addition, do not use this product in any way that deviates from the contents of the company's delivery specifications.
- Unless otherwise specified in this catalog or the delivery specifications, this product is intended for use in general electronic equipment (AV products, home appliances, commercial equipment, office equipment, information and communication equipment, etc.).
When this product is used for the following special cases, please separately discuss the delivery specifications suited to each application with the company. These include applications requiring special quality and reliability, wherein their failures or malfunctions may directly threaten human life or cause harm to the human body (e.g.: space/aircraft equipment, transportation/traffic equipment, combustion equipment, medical equipment, disaster prevention/crime prevention equipment, safety equipment, etc.).

Safety design and product evaluation

- Please ensure safety through protection circuits, redundant circuits, etc., in the customer's system design so that a defect in our company's product will not endanger human life or cause other serious damage.
- This catalog shows the quality and performance of individual parts. The durability of parts varies depending on the usage environment and conditions. Therefore, please ensure to evaluate and confirm the state of each part after it has been mounted in your product in the actual operating environment before use.
If you have any doubts about the safety of this product, then please notify us immediately, and be sure to conduct a technical review including the above protection circuits and redundant circuits at your company.

Laws / Regulations / Intellectual property

- The transportation of dangerous goods as designated by UN numbers, UN classifications, etc., does not apply to this product. In addition, when exporting products, product specifications, and technical information described in this catalog, please comply with the laws and regulations of the countries to which the products are exported, especially those concerning security export control.
- Each model of this product complies with the RoHS Directive (Restriction of the use of hazardous substances in electrical and electronic equipment) (2011/65/EU and (EU) 2015/863). The date of compliance with the RoHS Directive and REACH Regulation varies depending on the product model.
Further, if you are using product models in stock and are not sure whether or not they comply with the RoHS Directive or REACH Regulation, please contact us by selecting "Sales Inquiry" from the inquiry form.
- During the manufacturing process of this product and any of its components and materials to be used, Panasonic does not intentionally use ozone-depleting substances stipulated in the Montreal Protocol and specific bromine-based flame retardants such as PBBs (Poly-Brominated Biphenyls) / PBDEs (Poly-Brominated Diphenyl Ethers). In addition, the materials used in this product are all listed as existing chemical substances based on the Act on the Regulation of Manufacture and Evaluation of Chemical Substances.
- With regard to the disposal of this product, please confirm the disposal method in each country and region where it is incorporated into your company's product and used.
- The technical information contained in this catalog is intended to show only typical operation and application circuit examples of this product. This catalog does not guarantee that such information does not infringe upon the intellectual property rights of Panasonic or any third party, nor imply that the license of such rights has been granted.

Panasonic Industry will assume no liability whatsoever if the use of our company's products deviates from the contents of this catalog or does not comply with the precautions. Please be advised of these restrictions.

Built-in sensor contributes to energy savings, safety, and comfort.

Providing sensors for various aspects of our lives.

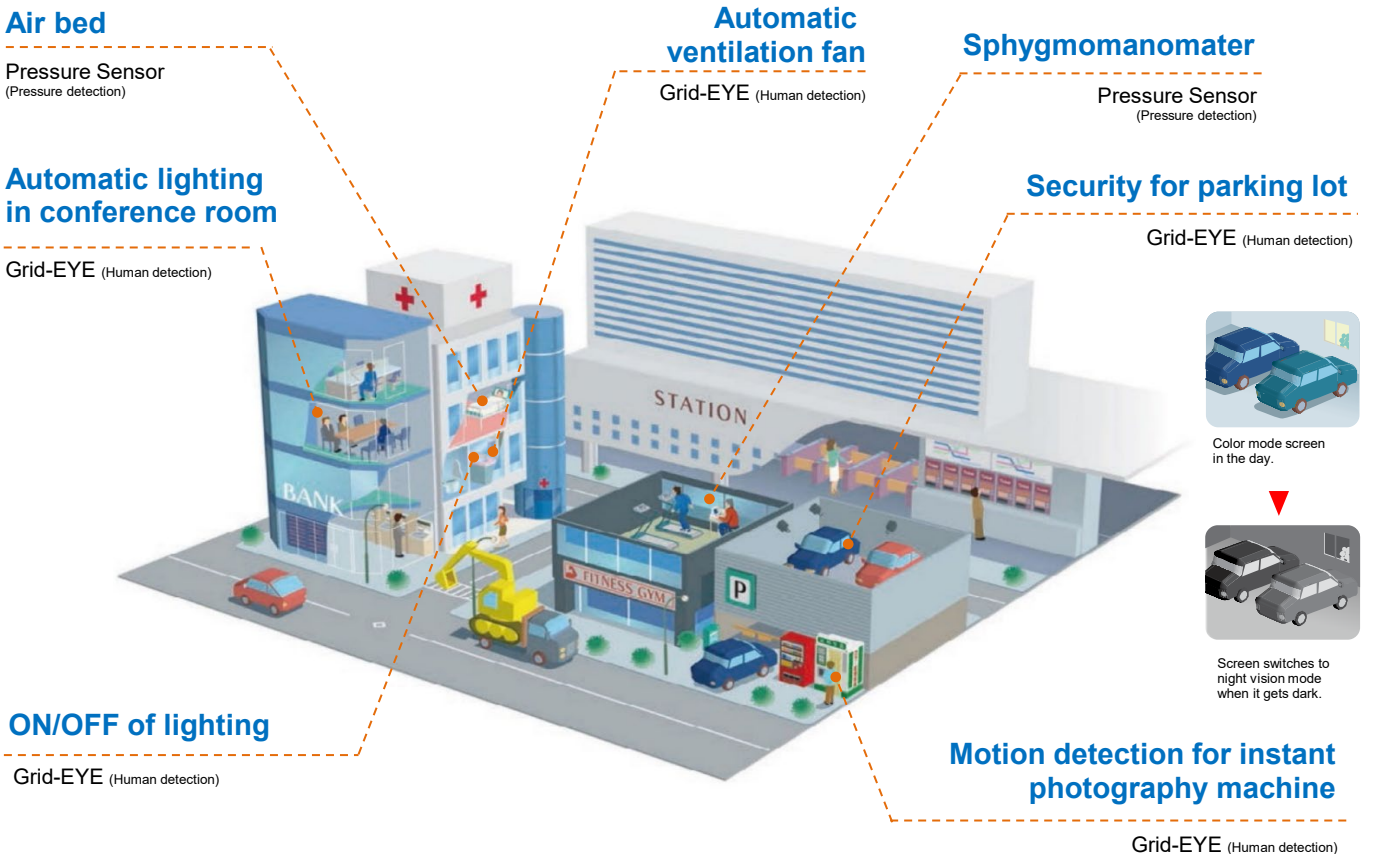
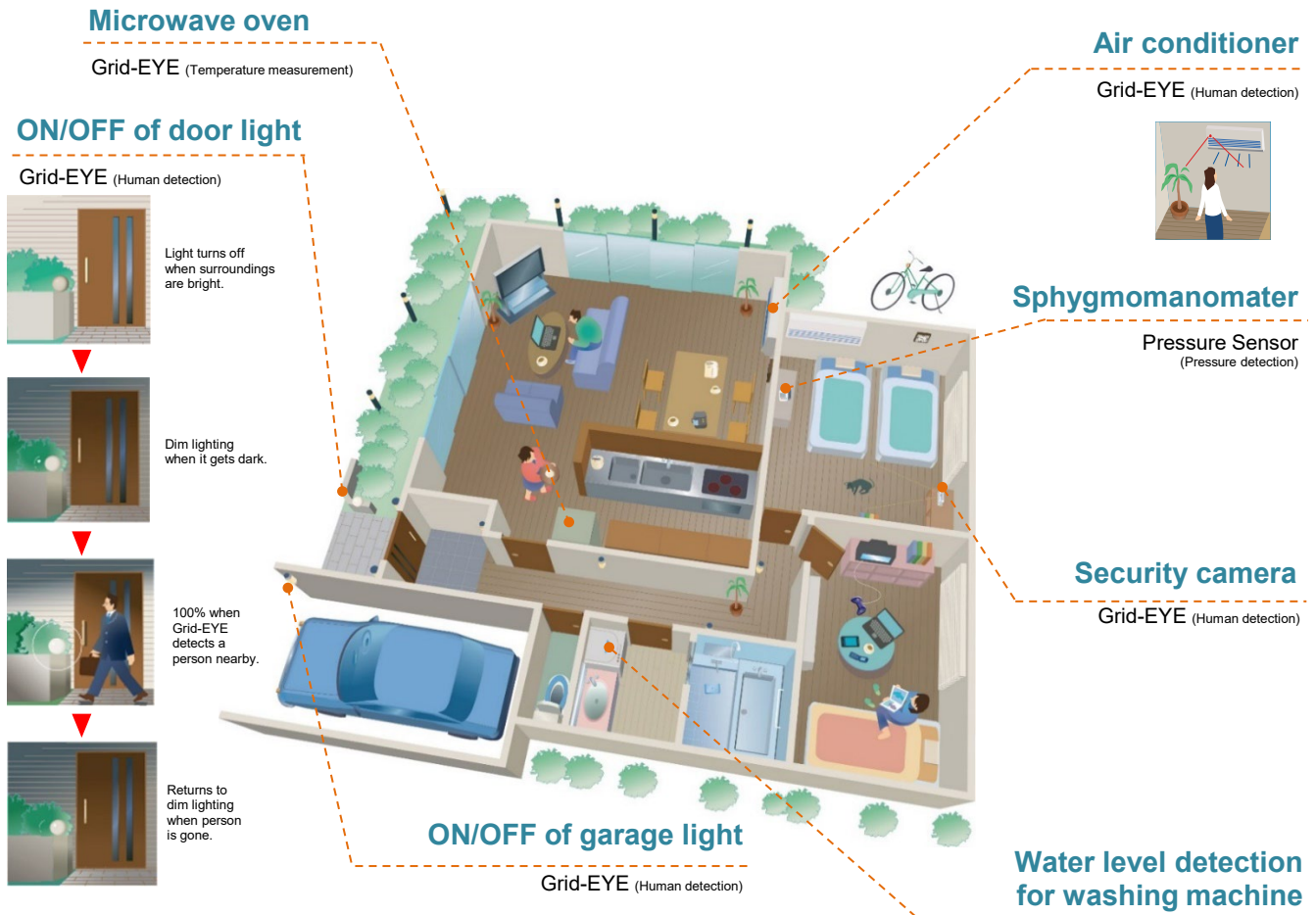

Human Heat

Infrared Array Sensors



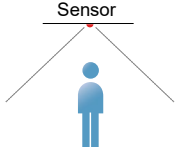





High Precision Infrared Array Sensor based on Advanced MEMS Technology

Product name	Detection method	Type		Characteristics
Thermopile type	Detecting the heat (infrared rays) of the human body and other objects. 	Operating voltage 3.3 V 5.0 V	Amplification factor High gain Low gain	<ul style="list-style-type: none"> ● Temperature detection achieved on a two dimensional area with 8 × 8 (64) pixels. ● Digital output ● Miniature SMD package
Grid-EYE				

Pressure

Pressure Sensors

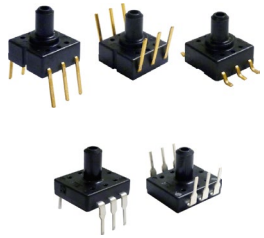
A wide range of rated pressure, including minute pressures

Product name	Pressure medium	Type(*Without glass base type)		Terminal direction	Pressure inlet hole length	Characteristics
PS-A Pressure Sensor 	Air	Rated pressure ±100, -100, 25, 50, 100, 200, 500, 1,000 * 40 kPa		Opposite the pressure inlet direction 	3 mm  5 mm 	<ul style="list-style-type: none"> ● Compact pressure sensor with built-in amplification and temperature compensation circuit ● Low pressure type ideal for water level detection applications added to lineup.
		<Low pressure type> 6 kPa			(SMD terminal)  5 mm Φ 3 mm  13.5 mm Φ5.45 mm 	
PS/PF Pressure Sensor 	Air	Rated pressure 4.9, 34.3, 49.0, 98.1, 196.1, 343.2, 490.3, 833.6, 980.7 k Pa	Bridge resistance 5 kΩ	Opposite the pressure inlet direction  (SMD terminal) 	-	<ul style="list-style-type: none"> ● Ultra-miniature base area 7.2 (W) x 7.2 (D) mm 0.283 (W) x 0.283 (D) inch ● A wide range of rated pressure, including a minute pressure.
		* 40 kPa 98.1, 980.7 kPa (PS only)	3.3 kΩ			

Infrared Array Sensor Grid-EYE

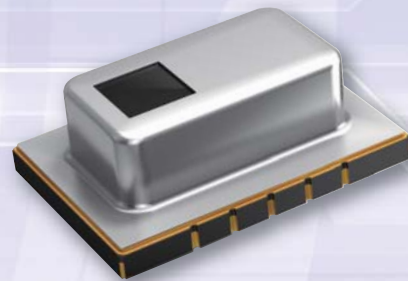

Matters to Be Observed When Using This Product

(Infrared array sensor / Grid-EYE)

Use environments

- The product introduced here is a thermopile infrared sensor that detects the amount of infrared. In the cases described below, power output from the sensor may change. You need to be careful about the sensor behavior in such cases. Confirm the performance and reliability of the sensor in its actual service condition. If necessary, adjust the power output for the actual service condition.
 - (1) Case where the sensor shows a partial temperature change because of a heater (MCU, heat source, etc.) present near the sensor, hot air or cool air hitting the sensor, or the sensor is in contact with the housing of equipment.
 - (2) Case where an obstacle is present between the sensor and a target object, e.g., an obstacle that transmits miniscule infrared rays (glass, acrylic, steam, etc.) is present between the sensor and the target object or foreign matter that transmits miniscule infrared rays (dust, waterdrop, etc.) deposits on the lens of the sensor.
- The sensor is used or mounted in an environment where the rated performance of the sensor specified in the specifications is guaranteed. To know the working temperature of the sensor, refer to its rated values. Keep the humidity in the service environment at 15% RH to 85% RH and avoid dew concentration as well as freezing. Use the sensor under an atmospheric pressure ranging from 86 kPa to 106 kPa.
- Vibrations or impacts applied to the sensor can damage the sensor, causing an operation failure, performance drop, etc. Be careful in such cases. A lens damaged by a load or impact applied can also cause an operation failure, performance drop, etc. Be careful in such cases.
- The sensor is not waterproof nor dustproof. In the service environment where the sensor is to be used, you need to take measures against moisture, dust, dew concentration, and freezing. A waterdrop on a soldered part causes electromigration along the soldered part, thus causing a short circuit. Make the soldered part waterproof.
- Avoid using or storing the sensor in a place where corrosive gas (organic solvent gas, sulfur dioxide gas, hydrogen sulfide gas, etc.) is present near the sensor. Using or storing the sensor in such a place may lead to an operation failure or performance drop.
- If an external voltage surge is applied to the sensor, the internal circuit may be destroyed. Use a surge absorber, etc., to prevent such a case.
- The sensor may malfunction when exposed to static electricity, lightning, or electric noise from a cellular phone, radio transmitter, broadcasting station, etc.
- The working ambient temperature (humidity) range is a temperature (humidity) range in which the sensor can be operated continuously. The humidity range, however, varies depending on temperature. Observe the humidity ranges shown in the following graphs. Avoid using the sensor continuously in a temperature (humidity) condition close to the limit of the temperature (humidity) range. This temperature range does not guarantee the durability of the sensor.

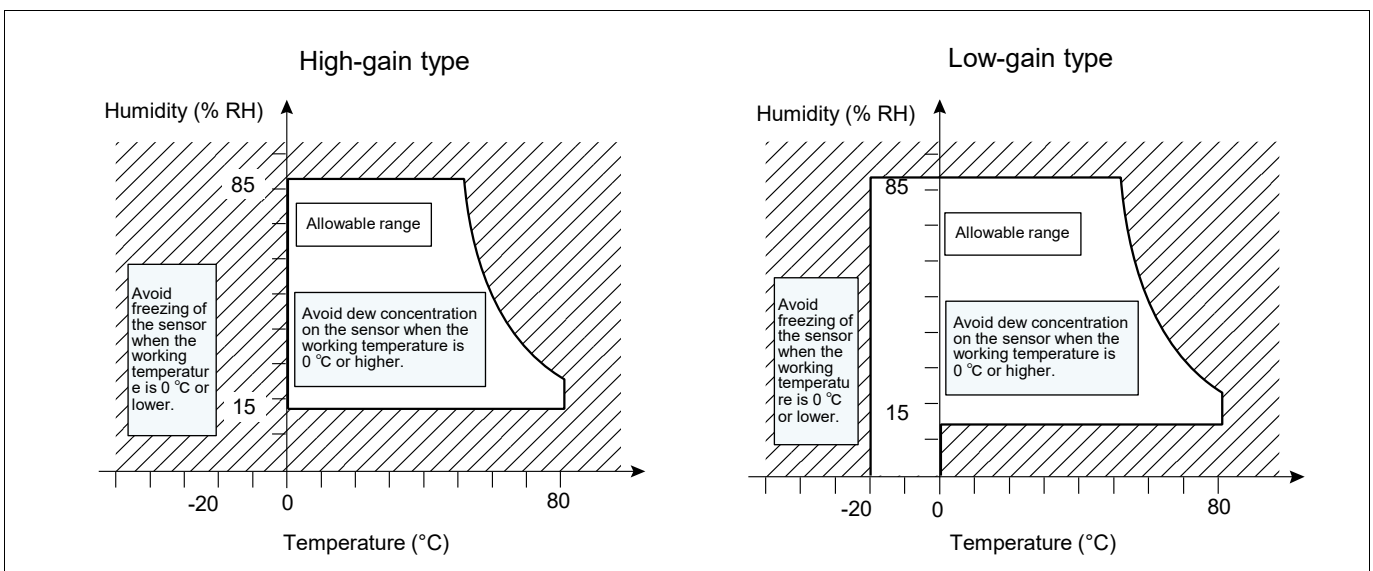

Response to anomalies and handling conditions

- When the sensor is heating abnormally or emitting a smell, stop using the sensor immediately by, for example, turning off its power supply.
- Do not use a sensor disassembled or remodeled, a sensor removed from the board, or a sensor dropped on the floor. High-frequency vibrations applied to the sensor may put it out of order. Do not use the sensor where impact will be applied from coming in contact with a metal object or another sensor.
- The sensor may fail under the influence of static electricity. When handling the sensor, wear anti-static clothes and make sure to ground the human body, measurement instruments/jigs used, and equipment for setting up the sensor.
- When foreign matter, waterdrops, etc., deposits on the lens, wipe it off gently with a soft cloth. Wiping the lens with a strong force can peel the lens off or damage the lens surface, causing problems. Be careful when cleaning the lens surface. Avoid cleaning the sensor with ultrasonic waves. This cleaning method may cause wire breakage and lead to a failure of the sensor.

Circuit design and circuit board design

- Confirm the pin arrangement by referring to specification drawings, etc., and connect leads correctly. Incorrect connection of the leads results in unexpected malfunctions, overheating, smoke generation, etc., which damage the circuit.
- Connect the sensor in accordance with the terminal connection diagram. Do not connect the sensor in reverse polarity to the power supply. It causes the sensor to fail or overheat.
Leave the free terminal unconnected. Connecting the free terminal creates a failure factor.
- Use a shielded cable to eliminate noise effects and make the cable as short as possible.
- Adopt a printed board with a land wide enough to affix the sensor thereon. When mounting the sensor on a printed board that is not the one recommended for it, sufficiently check the performance and quality of the sensor before using it.
- When power supplied to the sensor carries heavy noise, it may cause the sensor to malfunction. To ensure resistance to superposed power noise, set the recommended capacitor in the immediate vicinity of a section between input terminals (between a VDD node and a GND node), that is, in a location 20 mm distant in line length to the section.
Note, however, that you have to check the capacitor performance in the actual circuit configuration and reselect an optimum capacitor if necessary.
- The top of the sensor body (the surface where the product number is printed) serves as GND. Prevent any metal parts of other electronic components, etc., from coming in contact with this part.

Mounting conditions

- When soldering the sensor, reduce the effects of external heat on the sensor as much as possible. A sensor exposed to intensive heat thermally deforms, which may lead to its breakage or change in characteristics.
- When soldering the sensor manually, sufficiently clean the tip of the soldering iron and perform soldering within 3 seconds with a solder iron whose tip is heated to 350°C to 400°C (with a supplied power of 30 W to 60 W). Do not apply a load to the sensor terminals. It may change the output from the sensor.
- In the case of reflow soldering, we recommend solder-paste screen printing, which is a type of solder paste printing. When using highly active solder flux made mainly of halogen (chlorine, bromine, etc.), residual flux may affect the performance and reliability of the sensor. Check the effects of residual flux before using the solder flux.
- Self-alignment by solder may turn out to be insufficient. Align the sensor terminals with the wiring pattern carefully.

- A recommended reflow temperature profile is shown below. A profile temperature is defined as the temperature measurement taken at the printed board close to the sensor terminals. Assuming temperature measurement changes depending on board design details. Confirm, at the time of sensor mounting, that the printed board temperature measured at a point close to the sensor terminals matches the specified profile temperature and then mount the sensor.

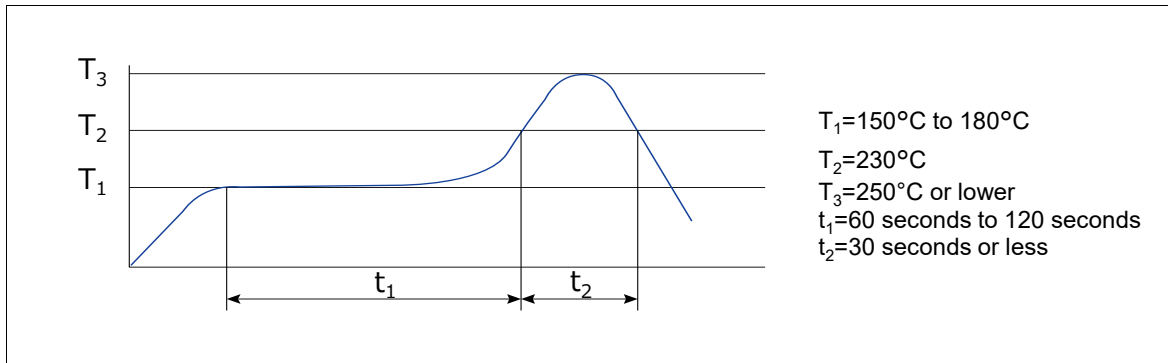

- When reflow-soldering the back of the board, after reflow-soldering the sensor, carry out a fixing process using, for example, an adhesive.
- When coating the board to prevent the degradation in insulation performance after the soldering process, be careful not to let any chemical stick to the lens of the sensor.
- When fixing the sensor by cutting/folding the board or using screws, etc., after mounting the sensor on the board, make sure that no stress is applied to the sensor or its soldered parts.
- Complete rework on soldered parts in a single process. When reworking a solder bridge, use a soldering iron with a flat tip and do not add solder flux to the bridge.
- The sensor has terminals exposed outside. If a metal piece, etc., comes in contact with the terminals, the sensor will output abnormal signals. Do not let a metal piece, a finger, etc., touch the sensor. Do not touch the sensor with bare hands. Wear gloves when handling the sensor.

Storage and transportation conditions

- Vibrations or impacts applied to the sensor during transportation may break the sensor. Handle the outer casing and reel carefully.
- Storing the sensor in an extremely unfavorable conditions may result in the lower solderability, damaged appearance, and degraded characteristics of the sensor. Store the sensor in a place where the temperature ranges from 0°C to 45°C , the humidity is 70% RH or lower, no sea breeze or corrosive gas (Cl_2 , H_2S , NH_3 , SO_2 , NO_x , etc.), little dust present, and direct sunlight is blocked.
- Because the sensor is susceptible to moisture, it is sealed in a moisture proof package. After the moisture proof package is unsealed, the sensor must be kept under storage conditions of 30°C and 60% RH and be used within one week. When keeping a sensor in storage for a long period (less than three months) after taking it out of the moisture proof package, put the sensor in a moisture proof bag filled with silica gel to protect the sensor from moisture.
- When using a sensor kept in storage for a long period, dry the sensor before subjecting it to the reflow-soldering process. When a sensor that has absorbed moisture is exposed to heat stress during the soldering process, moisture inside the sensor evaporates into expanding steam, creating internal stress that may swell or crack the sensor surface. Be mindful of the sensor's moisture absorption state and soldering conditions.
- Static electricity may destroy the sensor. Store and transport the sensor in an environment where no/little static electricity is generated (humidity 45% to 60%), and protect the sensor from static electricity by covering it with a conductive packaging material. When storing or transporting a sensor taken out of the package, put the sensor in an antistatic container.

Matters to Be Observed When Using This Product

(Infrared array sensor / Grid-EYE : Narrow angle type)

Use environments

- The product introduced here is a thermopile infrared sensor that detects the amount of infrared. In the cases described below, power output from the sensor may change. You need to be careful about the sensor behavior in such cases. Confirm the performance and reliability of the sensor in its actual service condition. If necessary, adjust the power output for the actual service condition.
 - (1) Case where the sensor shows a partial temperature change because of a heater (MCU, heat source, etc.) present near the sensor, hot air or cool air hitting the sensor, or the sensor is in contact with the housing of equipment.
 - (2) Case where an obstacle is present between the sensor and a target object, e.g., an obstacle that transmits miniscule infrared rays (glass, acrylic, steam, etc.) is present between the sensor and the target object or foreign matter that transmits miniscule infrared rays (dust, waterdrop, etc.) deposits on the lens of the sensor.
- The sensor is used or mounted in an environment where the rated performance of the sensor specified in the specifications is guaranteed. To know the working temperature of the sensor, refer to its rated values. Keep the humidity in the service environment at 15% RH to 85% RH and avoid dew concentration as well as freezing. Use the sensor under an atmospheric pressure ranging from 86 kPa to 106 kPa.
- Vibrations or impacts applied to the sensor can damage the sensor, causing an operation failure, performance drop, etc. Be careful in such cases. A lens damaged by a load or impact applied can also cause an operation failure, performance drop, etc. Be careful in such cases.
- The sensor is not waterproof nor dustproof. In the service environment where the sensor is to be used, you need to take measures against moisture, dust, dew concentration, and freezing. A waterdrop on a soldered part causes electromigration along the soldered part, thus causing a short circuit. Make the soldered part waterproof.
- Avoid using or storing the sensor in a place where corrosive gas (organic solvent gas, sulfur dioxide gas, hydrogen sulfide gas, etc.) is present near the sensor. Using or storing the sensor in such a place may lead to an operation failure or performance drop.
- If an external voltage surge is applied to the sensor, the internal circuit may be destroyed. Use a surge absorber, etc., to prevent such a case.
- The sensor may malfunction when exposed to static electricity, lightning, or electric noise from a cellular phone, radio transmitter, broadcasting station, etc.
- The working ambient temperature (humidity) range is a temperature (humidity) range in which the sensor can be operated continuously. The humidity range, however, varies depending on temperature. Observe the humidity ranges shown in the following graphs. Avoid using the sensor continuously in a temperature (humidity) condition close to the limit of the temperature (humidity) range. This temperature range does not guarantee the durability of the sensor.

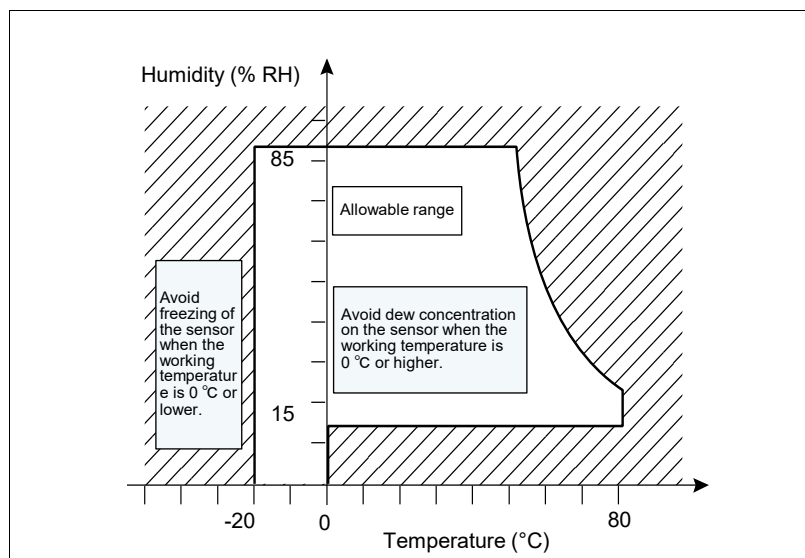

Response to anomalies and handling conditions

- When the sensor is heating abnormally or emitting a smell, stop using the sensor immediately by, for example, turning off its power supply.
- Do not use a sensor disassembled or remodeled, a sensor removed from the board, or a sensor dropped on the floor. High-frequency vibrations applied to the sensor may put it out of order. Do not use the sensor where impact will be applied from coming in contact with a metal object or another sensor.
- The sensor may fail under the influence of static electricity. When handling the sensor, wear anti-static clothes and make sure to ground the human body, measurement instruments/jigs used, and equipment for setting up the sensor.
- When foreign matter, waterdrops, etc., deposits on the lens, wipe it off gently with a soft cloth. Wiping the lens with a strong force can peel the lens off or damage the lens surface, causing problems. Be careful when cleaning the lens surface. Avoid cleaning the sensor with ultrasonic waves. This cleaning method may cause wire breakage and lead to a failure of the sensor.

Circuit design and circuit board design

- Confirm the pin arrangement by referring to specification drawings, etc., and connect leads correctly. Incorrect connection of the leads results in unexpected malfunctions, overheating, smoke generation, etc., which damage the circuit.
- Connect the sensor in accordance with the terminal connection diagram. Do not connect the sensor in reverse polarity to the power supply. It causes the sensor to fail or overheat. Make sure to connect a VPP node to a VDD node. Incorrect connection causes circuit failure.
- Adopt a printed board with a land wide enough to affix the sensor thereon. When mounting the sensor on a printed board that is not the one recommended for it, sufficiently check the performance and quality of the sensor before using it.

Storage and transportation conditions

- Vibrations or impacts applied to the sensor during transportation may break the sensor. Handle the outer casing and reel carefully.
- Storing the sensor in an extremely unfavorable condition may result in a damaged appearance and degraded characteristics of the sensor. Store the sensor in a place where the temperature ranges from 0 °C to 45 °C, the humidity is 70% RH or lower, no sea breeze or corrosive gas (Cl₂, H₂S, NH₃, SO₂, NO_x, etc.), little dust is present, and direct sunlight is blocked.
- Static electricity may destroy the sensor. Store and transport the sensor in an environment where no/little static electricity is generated (humidity 45% to 60%), and protect the sensor from static electricity by covering it with a conductive packaging material. When storing or transporting a sensor taken out of the package, put the sensor in an antistatic container.

Infrared Array Sensor Grid-EYE

Surface Mount Type

AMG88xx (High performance type)

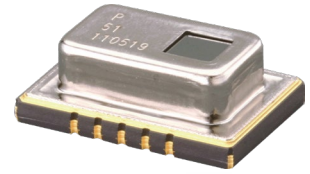

High precision infrared array sensor based on advanced MEMS technology

Feature

- Temperature detection of two-dimensional area: 8 × 8 (64 pixels)
- Digital output (capability of temperature value output)
- Compact SMD package (adaptively to reflow mounting)
- RoHS compliant

Recommended applications

- Home appliances (Microwaves and air-conditioners)
- Building automation (People counting, Air conditioning control)
- Home automation (People detection)
- Factory automation (Fault prevention)

Ordering information

AMG		8		8		3		4
Code	Vertical pixel	Code	Horizontal pixel	Code	Applied voltage	Code	Amplification factor	
8	8 pixels	8	8 pixels	3	3.3 V	3	High gain	
				5	5.0 V	4	Low gain	

Types

Product name	Number of pixel	Operating voltage	Amplification factor	Part number	Tape and reel package (pcs)
Infrared array sensor Grid-EYE	64 (Vertical 8 × Horizontal 8 Matrix)	3.3 V	High gain	AMG8833	1000
			Low gain	AMG8834	
		5.0 V	High gain	AMG8853	
			Low gain	AMG8854	

Rating

Item	Performance	
	High gain	Low gain
Applied voltage	3.3 V ± 0.3 V or 5.0 V ± 0.5 V	
Temperature range of measuring object	0 °C to 80 °C +32 °F to +176 °F	-20 °C ~ 100 °C -4 °F to +212 °F
Operating temperature range	0 °C to 80 °C +32 °F to +176 °F	-20 °C ~ 80 °C -4 °F to +176 °F
Storage temperature range	-20 °C to 80 °C -4 °F to +176 °F	-20 °C ~ 80 °C -4 °F to +176 °F

Absolute maximum ratings

Item	Absolute maximum ratings	Terminal
Applied voltage	-0.3 V to 6.5 V	VDD
Input voltage	-0.3 V to VDD +0.3 V	SCL, SDA, AD_SELECT
Output sink current	-10 mA to 10 mA	INT, SDA
Static electricity (Human Body Model)	1 kV	All terminals
Static electricity (Machine Model)	200 V	All terminals

Characteristics

Item	Performance	
	High gain	Low gain
Temperature accuracy	Typ. $\pm 2.5\text{ }^{\circ}\text{C}$ $\pm 4.5\text{ }^{\circ}\text{F}$	Typ. $\pm 3.0\text{ }^{\circ}\text{C}$ $\pm 5.4\text{ }^{\circ}\text{F}$
NETD ^{*1}	Typ. 0.05 K (in 1 fps setting ^{*2}) Typ. 0.16 K (in 10 fps setting)	
Viewing angle	Typ. 60 °	
Current consumption	Typ. 4.5 mA (normal mode) Typ. 0.2 mA (sleep mode)	
Setup time	Typ. 50 ms (Time to enable communication after setup) Typ. 15 s (Time to stabilize output after setup)	

*1: It is calculated from 4 pixels of centers.

*2: fps: frame per second

Performance

Item	Performance
Number of pixel	64 (Vertical 8 × Horizontal 8 Matrix)
External interface	I ² C
Frame rate	Typ. 1 fps or Typ. 10 fps
Operating mode ^{*3}	Normal Sleep
Output mode	Temperature output
Calculate mode	No moving average or Twice moving average
Temperature output resolution	0.25 $^{\circ}\text{C}$ 0.45 $^{\circ}\text{F}$
Number of sensor address	2 (I ² C slave address)
Thermistor output temperature range	$-20\text{ }^{\circ}\text{C}$ to $80\text{ }^{\circ}\text{C}$ $-4\text{ }^{\circ}\text{F}$ to $+176\text{ }^{\circ}\text{F}$
Thermistor output resolution	0.0625 $^{\circ}\text{C}$ 0.1125 $^{\circ}\text{F}$

*3: Normal Mode : normal operation mode; Sleep Mode: detection is off (output and data reading not possible)

Internal circuit

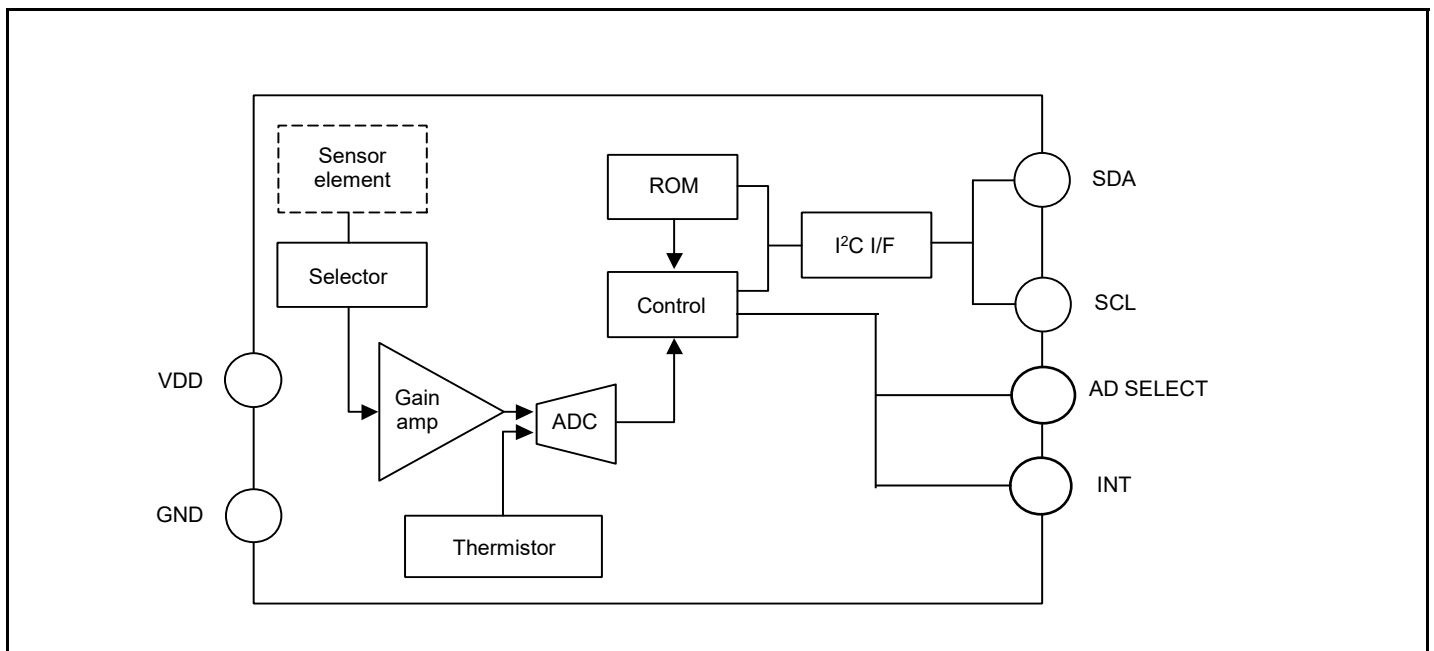

Pixel array and viewing angle

(1) Pixel array

Pixel array from 1 to 64 is shown below.

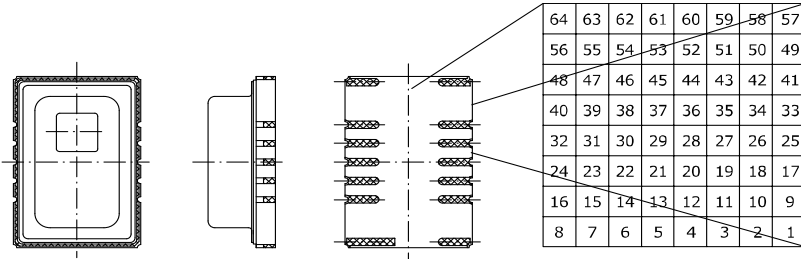

(2) Viewing angle (Typ.)

Sensor viewing angle is shown below.

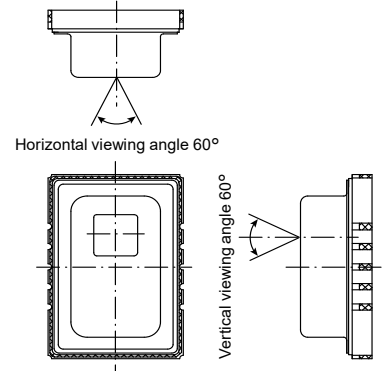

Optical properties

(1) Each pixel's viewing central angle (Typ.)

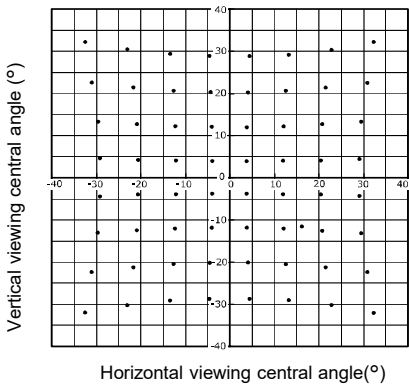

(2) Each pixel's viewing angle (Typ.)

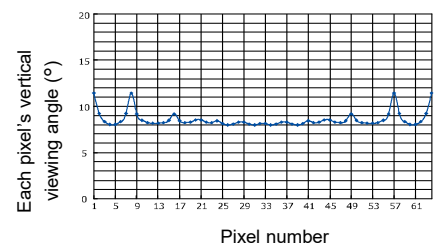
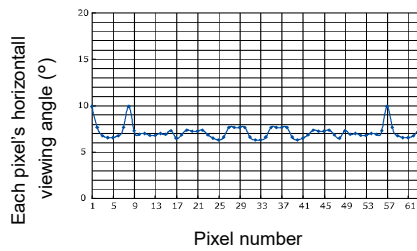

Dimensions

External dimensions (Typ.)

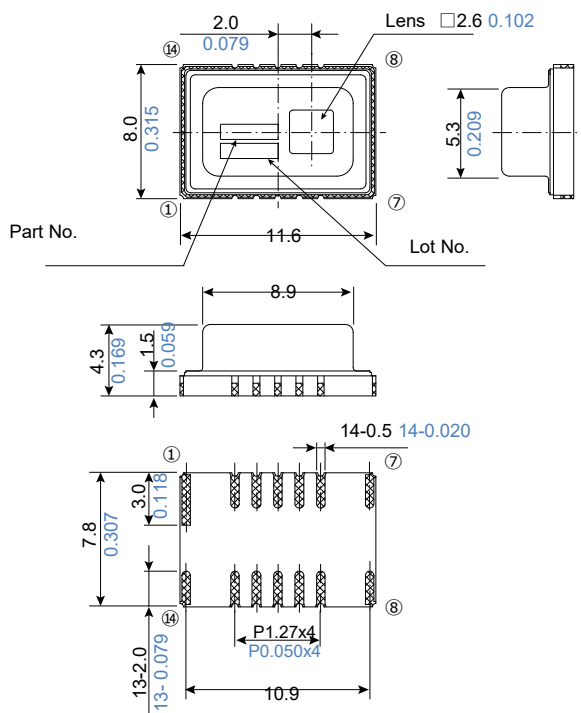

Recommended PC board pad (Typ.)

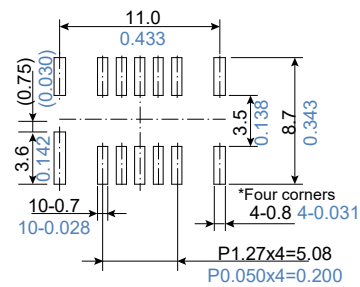

Number	Terminal name
①	NC
②	SDA
③	SCL
④	INT
⑤	AD_SELECT
⑥	GND
⑦	NC

Number	Terminal name
⑧	NC
⑨	VDD
⑩	AVDD-PC
⑪	NC
⑫	DVDD-PC
⑬	VPP
⑭	NC

Note) NC : Leave terminal unconnected.

Unit : mm inch

External circuit

(1) In case of setting I2C slave address of the sensor 1101000

※ Connect terminal 5 (AD_SELECT) to GND.

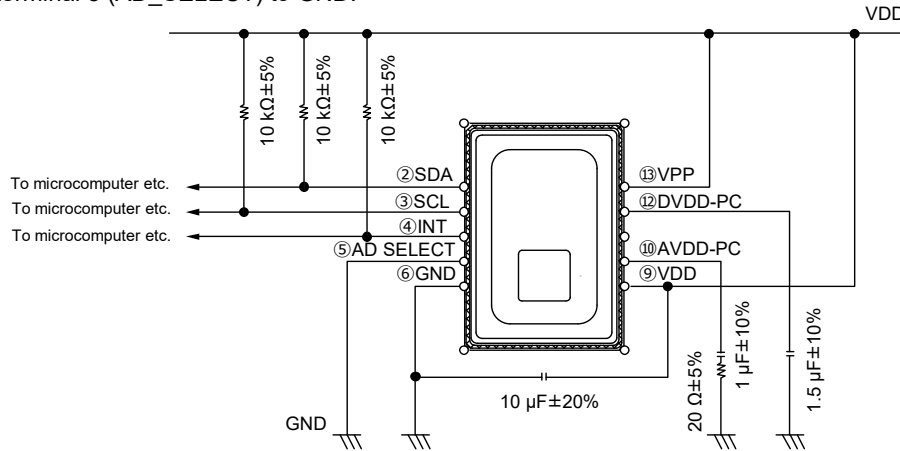

(2) In case of setting I2C slave address of the sensor 1101001

※ Connect terminal 5 (AD_SELECT) to VDD.

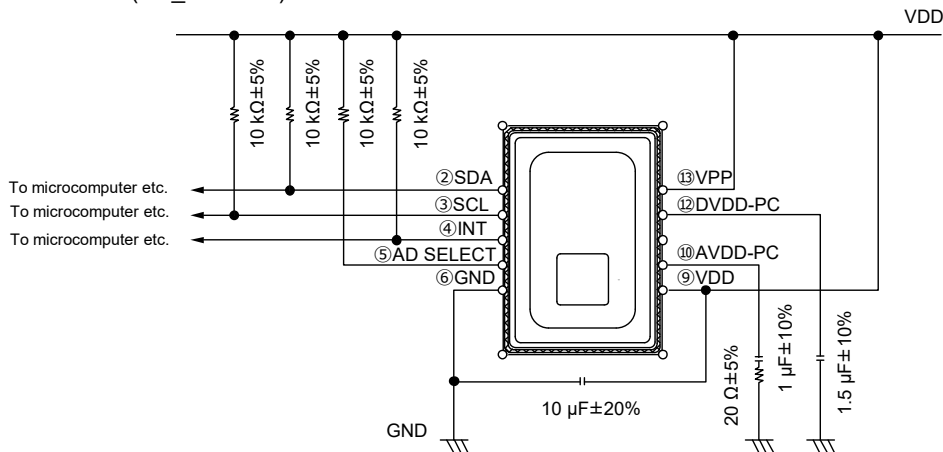

- This circuit is an example to drive Infrared Array Sensor “Grid-EYE”, so that our company will not take any responsibility of loss which is due to this circuit.
- The wiring connected to VDD are same electrical potential (same supply voltage).
- If there is a difference of electric potential between the terminals, it can be cause of breakdown.
- Connect wiring to solid GND with wide and short pattern on PCB.
- If wiring pattern is designed thin and long, temperature accuracy will be degraded.

Packing format (Tape and reel)

Tape dimensions (Typ.)

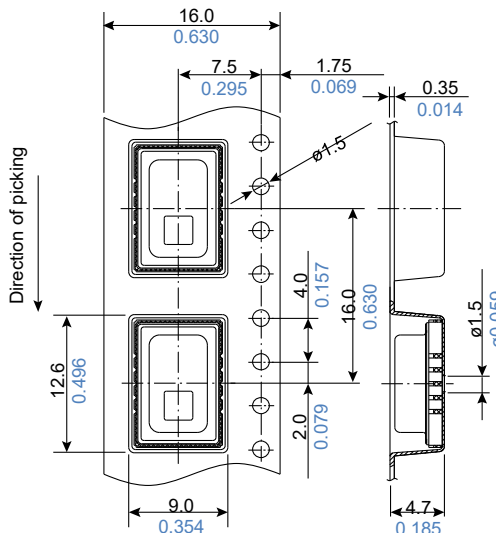

Dimensions of tape reel (Typ.)

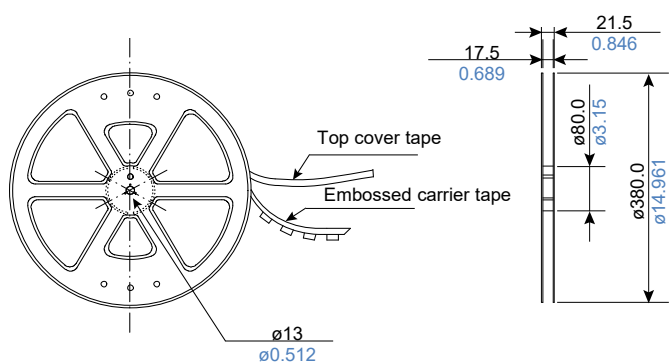

Unit : mm inch

Carton packing

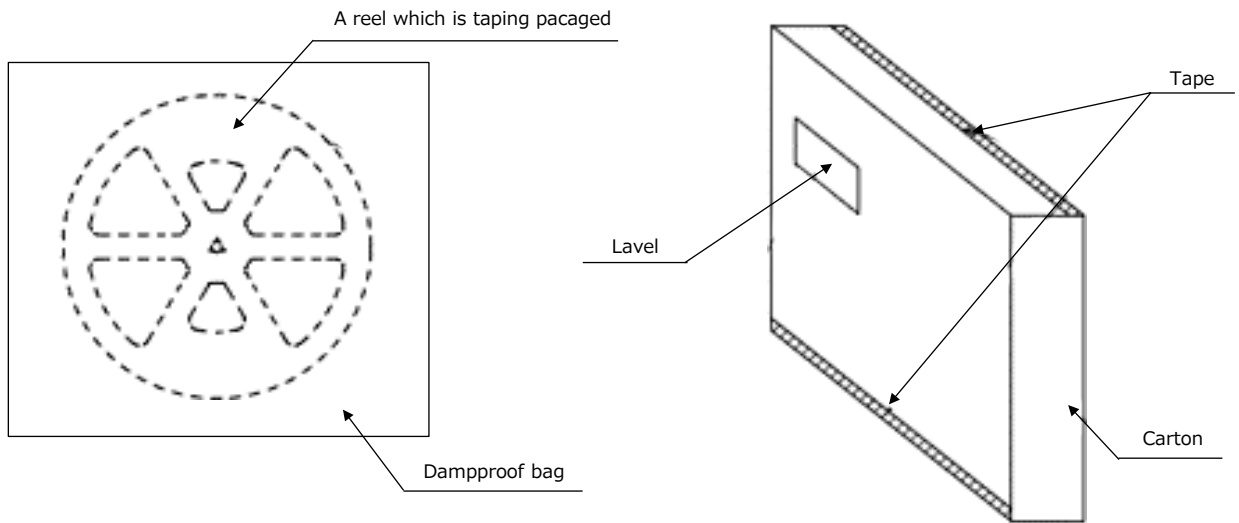

1. The number packed by 1 reel is up to 1000 pcs.
2. The end of the carrier tape are fixed by tape.
3. Inside the dampproof bag is not deaerated

Infrared Array Sensor Grid-EYE

Surface Mount Type

AMG88x543 (Wide angle type)

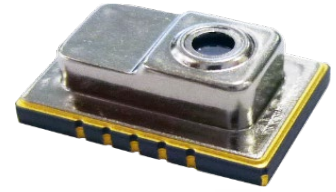

Feature

- Temperature detection of two-dimensional area: 8 × 8 (64 pixels)
- Digital output (capability of temperature value output)
- Compact SMD package (adaptively to reflow mounting)
- RoHS compliant

Recommended applications

- Energy saving at office (air-conditioning/lighting control)
- Automatic doors/elevators

Ordering information

AMG	8	8	3	543			
Code	Vertical pixel	Code	Horizontal pixel	Code	Power supply voltage	Code	Fixed value
8	8 pixels	8	8 pixels	3	3.3 V	543	Fixed value
				5	5.0 V		

Types

Product name	Number of pixel	Operating voltage	Part number	Tape and reel package (pcs)
Infrared array sensor Grid-EYE	64 (Vertical 8 × Horizontal 8 Matrix)	3.3 V	AMG883543	1000
		5.0 V	AMG885543	

Rating

Item	Performance
Applied voltage	3.3 V ± 0.3 V or 5.0 V ± 0.5 V
Temperature range of measuring object	0 °C to 80 °C +32 °F to +176 °F
Operating temperature range	0 °C to 80 °C +32 °F to +176 °F
Storage temperature range	-20 °C to 80 °C -4 °F to +176 °F

Absolute maximum ratings

Item	Absolute maximum ratings	Terminal
Applied voltage	-0.3 V to 6.5 V	VDD
Input/Output voltage	-0.3 V to VDD +0.3 V	SCL, SDA, AD_SELECT
Output sink current	-10 mA to 10 mA	INT, SDA
Static electricity (Human Body Model)	± 1 kV	All terminals
Static electricity (Machine Model)	± 200 V	All terminals

Characteristics

Item	Performance
Temperature accuracy ^{*1 *2}	Average value of total pixels is within Typ. $\pm 2.5^{\circ}\text{C}$ $\pm 4.5^{\circ}\text{F}$
NETD ^{*3}	1fps: Typ. 0.09°C 10fps: Typ. 0.27°C
Viewing angle	Typ. 90°
Optical axis gap	Within Typ. $\pm 10^{\circ}$
Current consumption	Typ. 4.5 mA (Normal mode) Typ. 0.2 mA (Sleep mode)
Setup time	Typ. 50 ms (Time to enable communication after setup) Typ. 15 s (Time to stabilize output after setup)

*1: Temperature output after starting in normal mode and waiting longer than setup time.

*2: The measurement conditions for guaranteed characteristic are as follows.

- Measurement equipment : inspection equipment in our manufacturing process
- Ambient humidity : standard humidity (Around 65%RH)
- Frame rate : 10fps
- Operation temperature : standard temperature (Around 20°C)

- Measurement object and temperature : black body, 25°C , 50°C , 75°C
- Moving average : setting off
- Measurement value of each pixel: Average value of multiple frame outputs
- Average value of all pixels: Average value of total pixels measurement values

*3: This value are central 4 pixels which are No.28, No.29, No.36, No.37.

Performance

Item	Performance
Number of pixel	64 (Vertical 8 × Horizontal 8 Matrix)
External interface	I ² C
Frame rate	Typ. 1 fps or Typ. 10 fps
Operating mode	Normal (Detection on) Sleep (Detection off)
Output mode	Temperature output
Calculate mode	No moving average or Twice moving average
Temperature output resolution	0.25°C 0.45°F
Number of sensor address	2 (I ² C slave address))
Thermistor output temperature range	-20°C to 80°C -4°F to $+176^{\circ}\text{F}$
Thermistor output resolution	0.0625°C 0.1125°F

Internal circuit

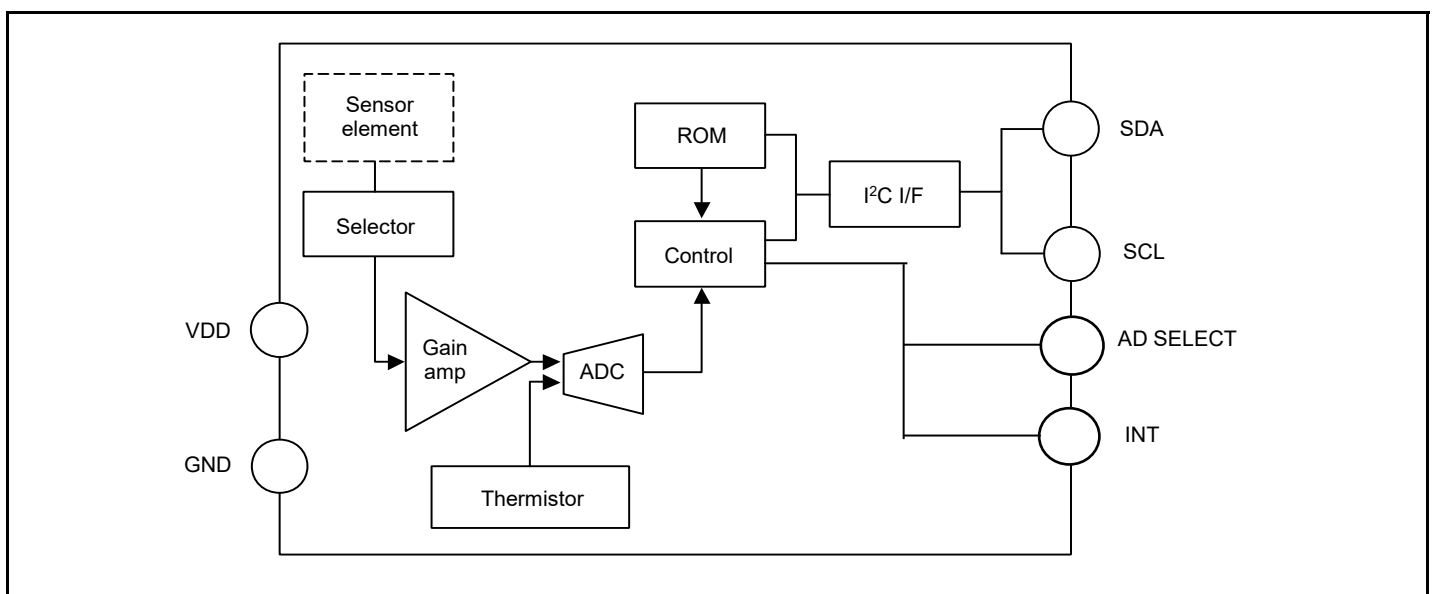

Pixel array and viewing angle

(1) Pixel array

Pixel array from 1 to 64 is shown below.

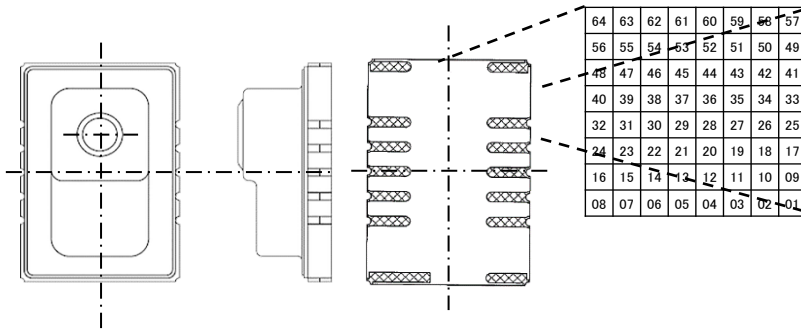

(2) Viewing angle (Typ.)

Sensor viewing angle is shown below.

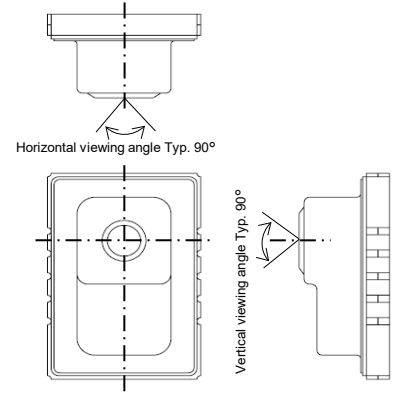

Optical properties

(1) Each pixel's viewing central angle (Typ.)

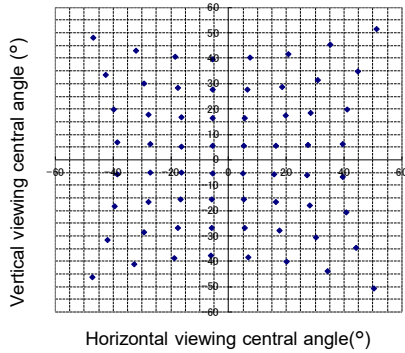

(2) Each pixel's viewing angle (Typ.)

Sensor viewing angle is shown below.

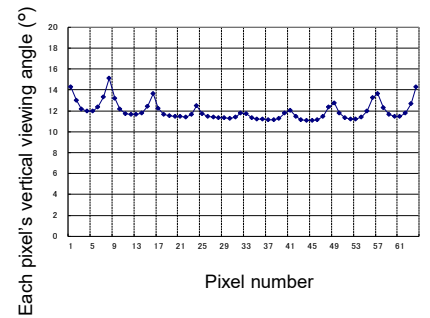
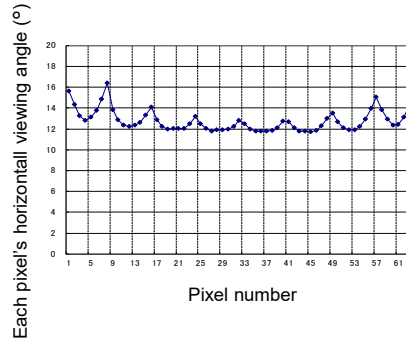

Dimensions

External dimensions (Typ.)

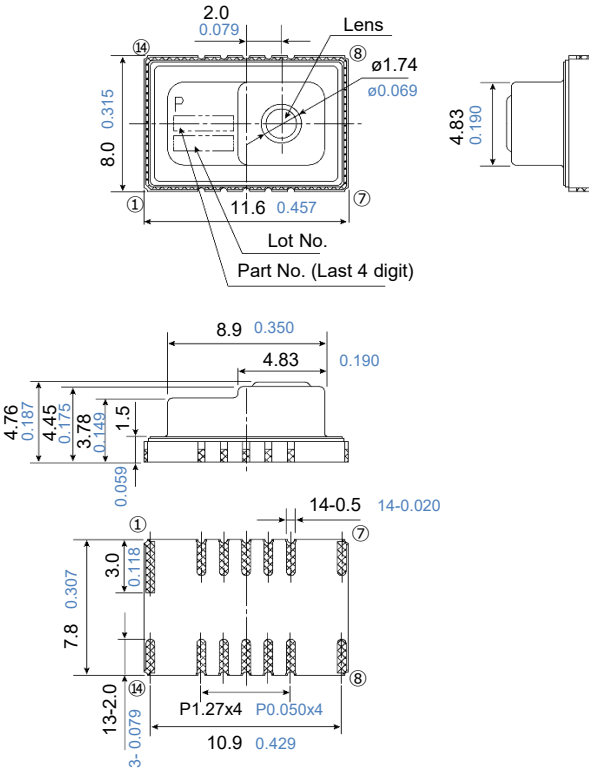

Recommended PC board pad (Typ.)

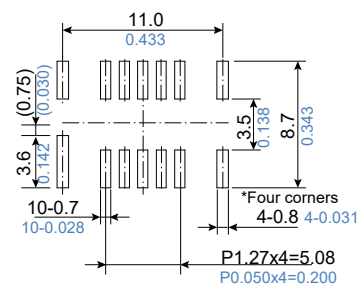

Number	Terminal name
①	NC
②	SDA
③	SCL
④	INT
⑤	AD_SELECT
⑥	GND
⑦	NC

Number	Terminal name
⑧	NC
⑨	VDD
⑩	AVDD-PC
⑪	NC
⑫	DVDD-PC
⑬	VPP
⑭	NC

Note) NC : Leave terminal unconnected.

Unit : mm inch

External circuit

(1) In case of setting I2C slave address of the sensor 1101000
 ※ Connect terminal 5 (AD_SELECT) to GND.

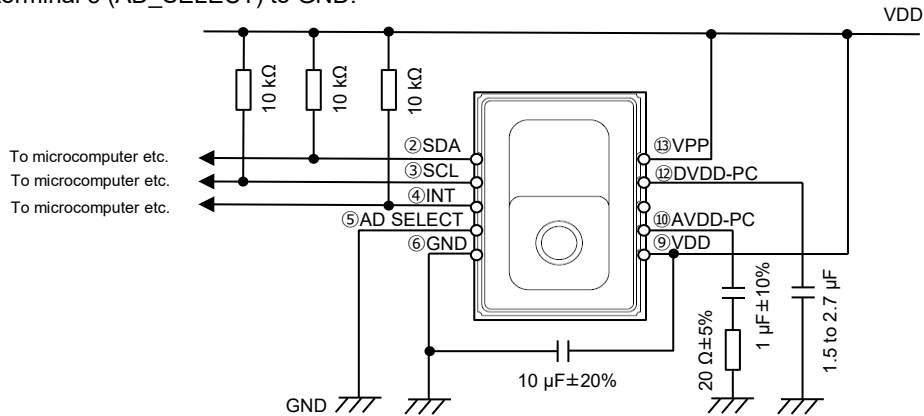

(2) In case of setting I2C slave address of the sensor 1101001
 ※ Connect terminal 5 (AD_SELECT) to VDD.

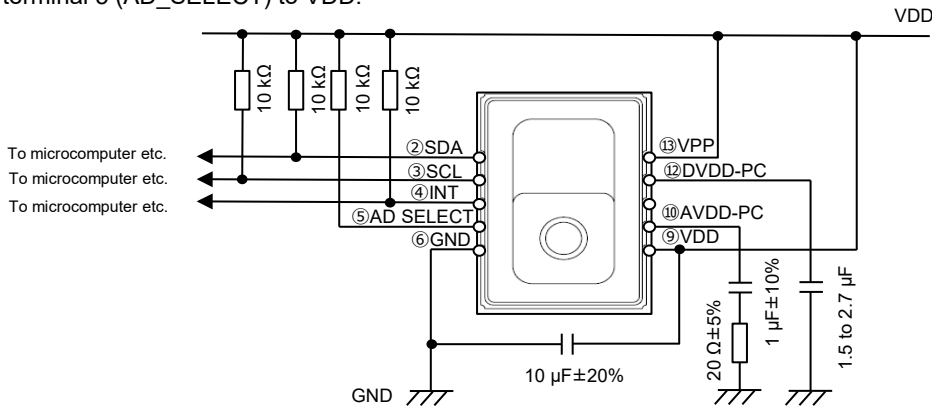

- This circuit is an example to drive Infrared Array Sensor “Grid-EYE”, so that our company will not take any responsibility of loss which is due to this circuit.
- The wiring connected to VDD are same electrical potential (same supply voltage).
- If there is a difference of electric potential between the terminals, it can be cause of breakdown.
- Connect wiring to solid GND with wide and short pattern on PCB.
- If wiring pattern is designed thin and long, temperature accuracy will be degraded.

Packing format (Tape and reel)

Tape dimensions (Typ.)

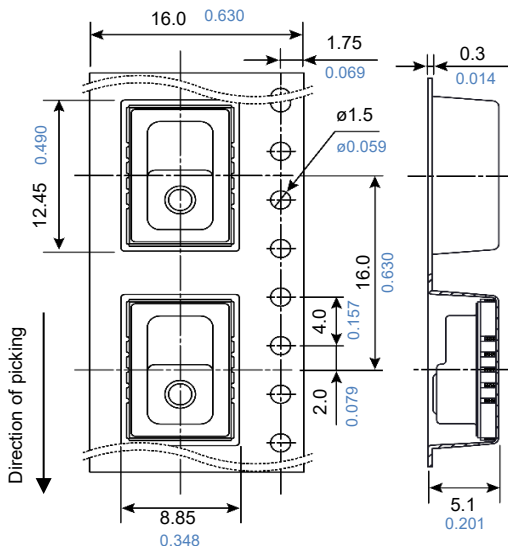

Dimensions of tape reel (Typ.)

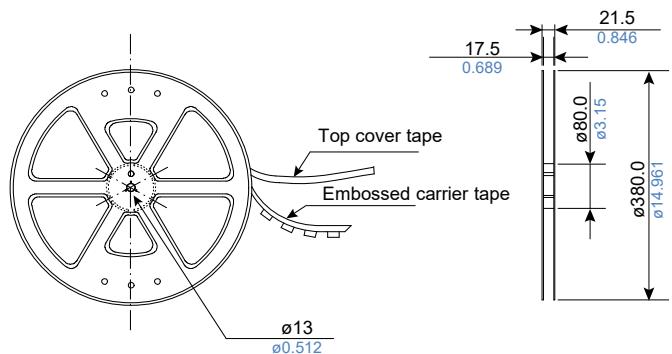

Unit : mm inch

Infrared Array Sensor Grid-EYE

Surface Mount Type

AMG883642 (Narrow type)

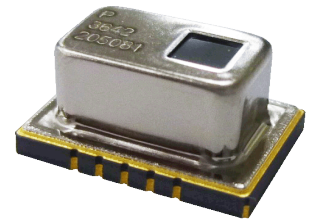

High precision infrared array sensor based on advanced MEMS technology

Feature

- Temperature detection of two-dimensional area: 8 × 8 (64 pixels)
- Digital output (capability of temperature value output)
- Compact SMD package (adaptively to reflow mounting)
- RoHS compliant

Recommended applications

- Home appliances (Microwaves and air-conditioners)
- Building automation (People counting, Air conditioning control)
- Home automation (People detection, heat source detection)
- Factory automation (Fault prevention)

Ordering information

AMG	8	8	3	642			
Code	Vertical pixel	Code	Horizontal pixel	Code	Power supply voltage	Code	Field of view
8	8 pixels	8	8 pixels	3	3.3 V	642	Horizontal Typ.35.6° Vertical Typ.35.6°

Types

Product name	Number of pixel	Operating voltage	Part number	Tape and reel package (pcs)
Infrared array sensor Grid-EYE	64 (Vertical 8 × Horizontal 8 Matrix)	3.3 V	AMG883642	800

Rating

Item	Performance
Applied voltage	3.3 V ± 0.3 V
Temperature range of measuring object	-20 °C ~ 100 °C -4 °F to +212 °F
Operating temperature range	-20 °C ~ 80 °C -4 °F to +176 °F
Storage temperature range	-20 °C ~ 80 °C -4 °F to +176 °F

Absolute maximum ratings

Item	Absolute maximum ratings	Terminal
Applied voltage	-0.3 V to 6.5 V	VDD
Input voltage	-0.3 V to VDD +0.3 V	SCL, SDA, AD_SELECT
Output sink current	-10 mA to 10 mA	INT, SDA
Static electricity (Human Body Model)	1 kV	All terminals
Static electricity (Machine Model)	200 V	All terminals

Characteristics

Item	Performance
Temperature accuracy	Typ. $\pm 3.0\text{ }^{\circ}\text{C}$ $\pm 5.4\text{ }^{\circ}\text{F}$
NETD ^{*1}	Typ. 0.11 K (in 1 fps setting ^{*2}) Typ. 0.35 K (in 10 fps setting)
Viewing angle	Typ. 35.6 °
Current consumption	Typ. 4.5 mA (normal mode) Typ. 0.2 mA (sleep mode)
Setup time	Typ. 50 ms (Time to enable communication after setup) Typ. 15 s (Time to stabilize output after setup)

*1: It is calculated from 4 pixels of centers.

*2: fps: frame per second

Performance

Item	Performance
Number of pixel	64 (Vertical 8 × Horizontal 8 Matrix)
External interface	I ² C
Frame rate	Typ. 1 fps or Typ. 10 fps
Operating mode ^{*3}	Normal Sleep
Output mode	Temperature output
Calculate mode	No moving average or Twice moving average
Temperature output resolution	0.25 $^{\circ}\text{C}$ 0.45 $^{\circ}\text{F}$
Number of sensor address	2 (I ² C slave address))
Thermistor output temperature range	$-20\text{ }^{\circ}\text{C}$ to $80\text{ }^{\circ}\text{C}$ $-4\text{ }^{\circ}\text{F}$ to $+176\text{ }^{\circ}\text{F}$
Thermistor output resolution	0.0625 $^{\circ}\text{C}$ 0.1125 $^{\circ}\text{F}$

*3: Normal Mode : normal operation mode; Sleep Mode: detection is off (output and data reading not possible)

Internal circuit

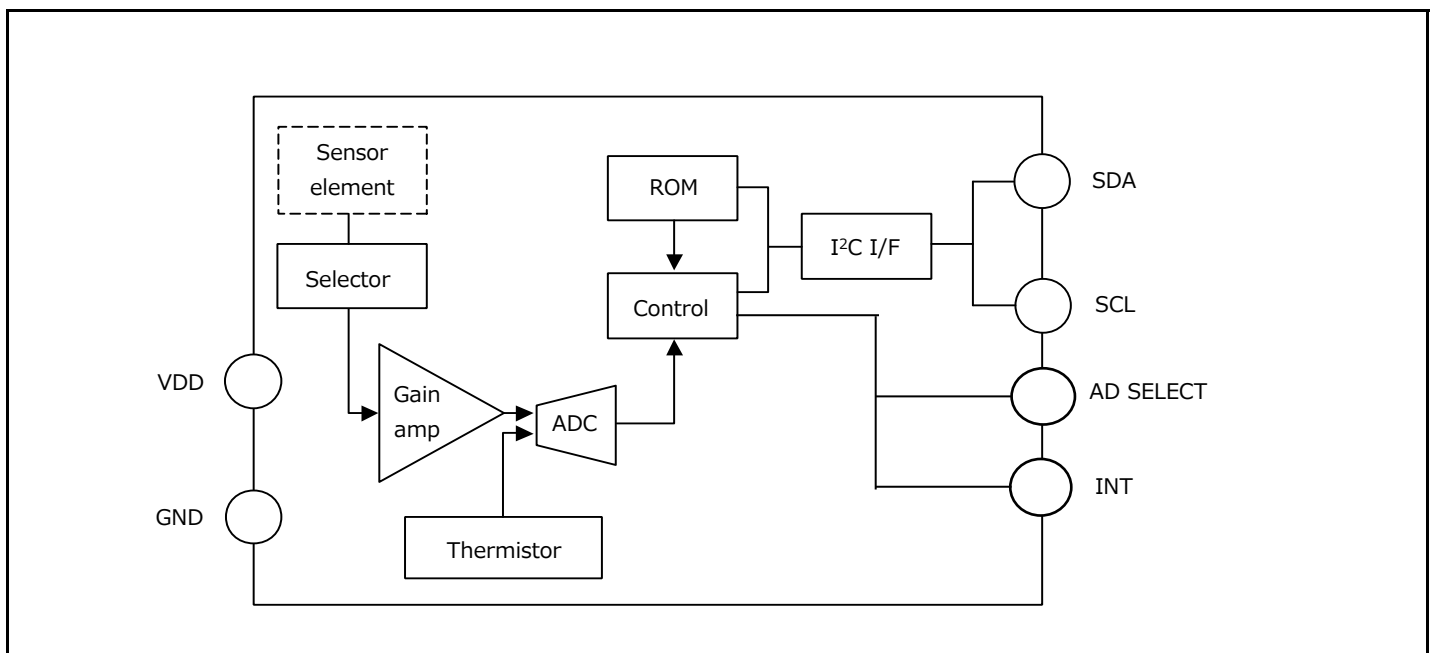

Pixel array and viewing angle

(1) Pixel array

Pixel array from 1 to 64 is shown below.

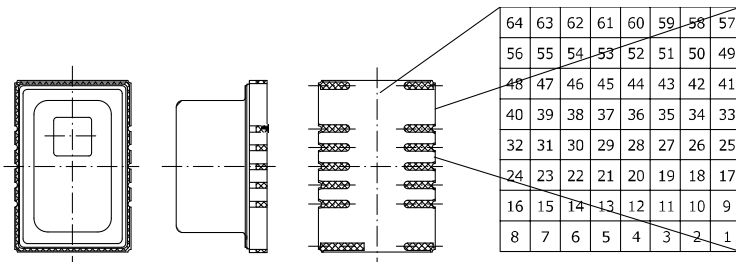

(2) Viewing angle (Typ.)

Sensor viewing angle is shown below.

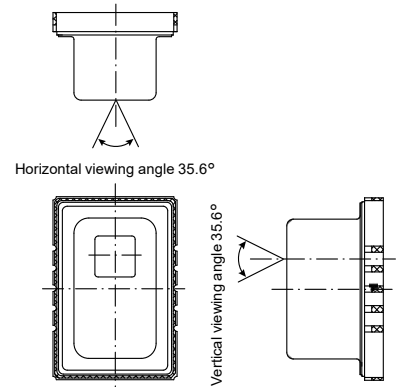

Optical properties

(1) Each pixel's viewing central angle (Typ.)

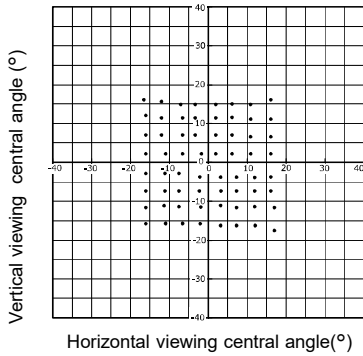

(2) Each pixel's viewing angle (Typ.)

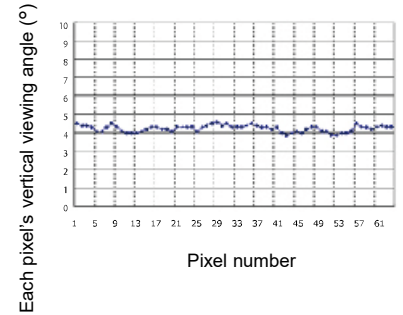
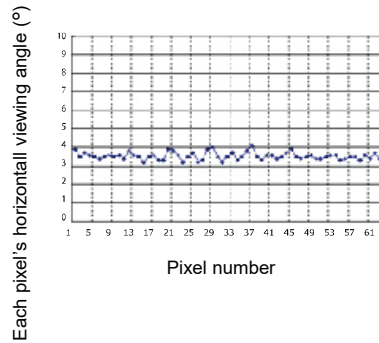

Dimensions

External dimensions (Typ.)

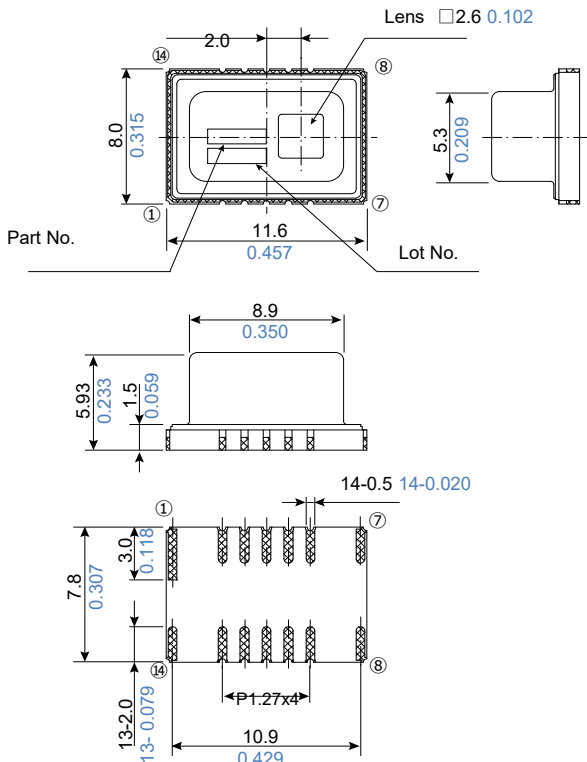

Recommended PC board pad (Typ.)

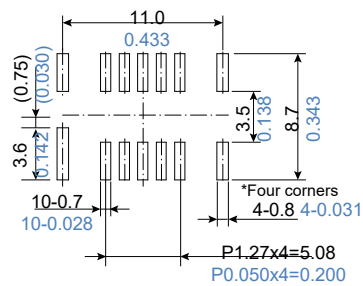

Number	Terminal name
①	NC
②	SDA
③	SCL
④	INT
⑤	AD_SELECT
⑥	GND
⑦	NC

Number	Terminal name
⑧	NC
⑨	VDD
⑩	AVDD-PC
⑪	NC
⑫	DVDD-PC
⑬	VPP
⑭	NC

Note) NC : Leave terminal unconnected.

Unit : mm inch

External circuit

(1) In case of setting I2C slave address of the sensor 1101000

※ Connect terminal 5 (AD_SELECT) to GND.

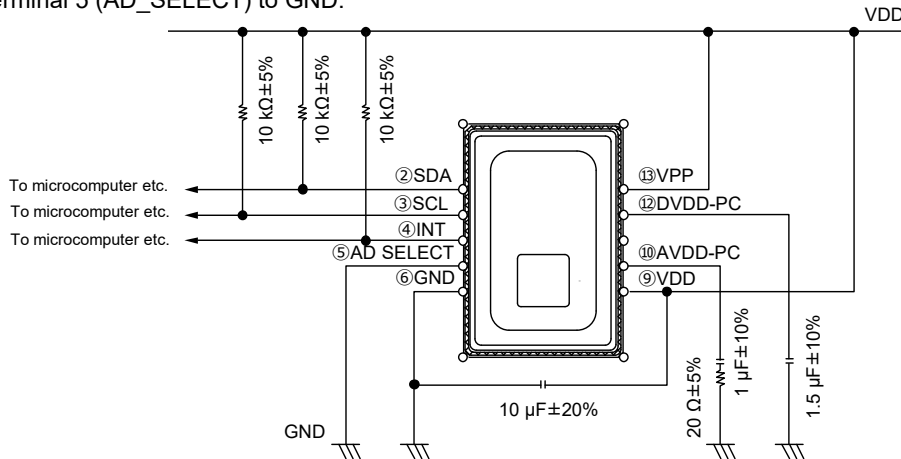

(2) In case of setting I2C slave address of the sensor 1101001

※ Connect terminal 5 (AD_SELECT) to VDD.

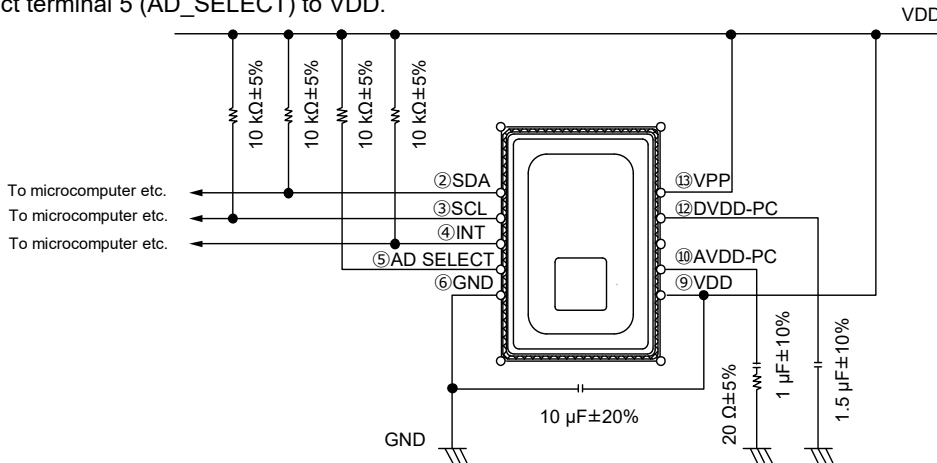

- This circuit is an example to drive Infrared Array Sensor “Grid-EYE”, so that our company will not take any responsibility of loss which is due to this circuit.
- The wiring connected to VDD are same electrical potential (same supply voltage).
- If there is a difference of electric potential between the terminals, it can be cause of breakdown.
- Connect wiring to solid GND with wide and short pattern on PCB.
- If wiring pattern is designed thin and long, temperature accuracy will be degraded.

Packing format (Tape and reel)

Tape dimensions (Typ.)

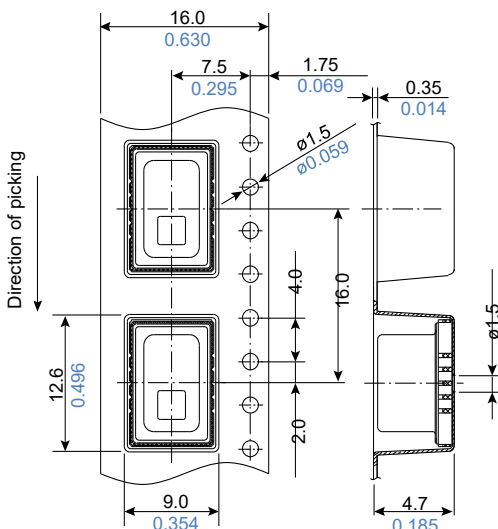

Dimensions of tape reel (Typ.)

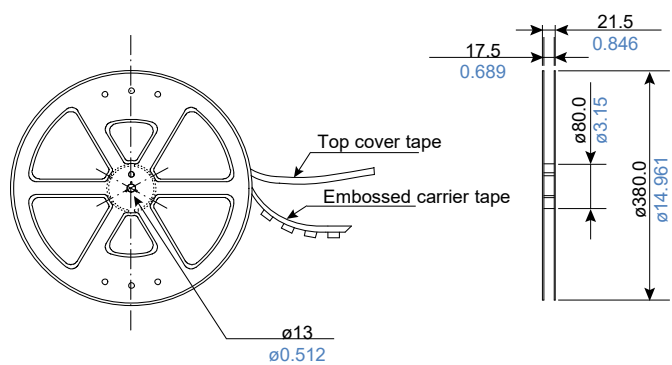

Unit : mm inch

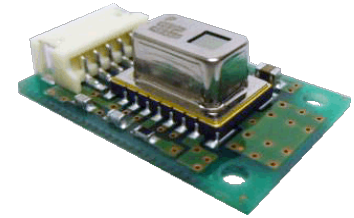

Infrared Array Sensor Grid-EYE

PC Board Mounting

AMG8854M01 (Narrow type)

High precision infrared array sensor based on advanced MEMS technology

Feature

- Temperature detection of two-dimensional area: 8 × 8 (64 pixels)
- Digital output (capability of temperature value output)
- PC board mounting with connector (5 pin)
- RoHS compliance

Recommended applications

- Home appliance (microwaves and air-conditioners)
- Energy saving at office (air conditioning control)
- Home automation (heat source detection)
- Factory automation (Fault prevention)

Ordering information

AMG	8	8	5	4M01			
Code	Vertical pixel	Code	Horizontal pixel	Code	Applied voltage	Code	Product form
8	8 : 8 pixels	8	8 : 8 pixels	5	5.0 V	4M01	PC board mounting

Types

Product name	Number of pixel	Operating voltage	Part number	Tape and reel package (pcs)
Infrared array sensor Grid-EYE Narrow angle type	64 (Vertical 8 × Horizontal 8 Matrix)	5.0 V	AMG8854M01	1000

Rating

Item	Performance
Applied voltage	5.0 V ± 0.5 V
Temperature range of measuring object	-20 °C to 100 °C -4 °F to +212 °F
Operating temperature range	-20 °C to 80 °C -4 °F to +176 °F
Storage temperature range	-20 °C to 80 °C -4 °F to +176 °F

Absolute maximum ratings

Item	Absolute maximum ratings	Terminal
Applied voltage	-0.3 V to 6.5 V	VDD
Input voltage	-0.3 V to VDD +0.3 V	SCL, SDA, AD_SELECT
Output sink current	-10 mA to 10 mA	INT, SDA
Static electricity (Human body model)	1 kV	All terminals
Static electricity (Machine model)	200 V	All terminals

Characteristics

Item	Performance
Temperature accuracy	Typ. $\pm 3.0\text{ }^{\circ}\text{C}$ $\pm 5.4\text{ }^{\circ}\text{F}$
Viewing angle	Typ. 35.6 °
Current consumption	Typ. 4.5 mA (normal mode) Typ. 0.2 mA (sleep mode)
Setup time	Typ. 50 ms (Time to enable communication after setup) 15 s or more (Time to stabilize output after setup)

Performance

Item	Performance
Number of pixel	64 (Vertical 8 × Horizontal 8 Matrix)
External interface	I ² C
Frame rate	Typ. 1 fps or Typ. 10 fps ^{*1}
Operating mode ^{*2}	Normal Sleep
Output mode	Temperature output
Calculate mode	No moving average or Twice moving average
Temperature output resolution	0.25 $^{\circ}\text{C}$ 0.45 $^{\circ}\text{F}$
Number of sensor address	1 (I ² C slave address : 1101 000)
Thermistor output temperature range	-20 $^{\circ}\text{C}$ to 80 $^{\circ}\text{C}$ -4 $^{\circ}\text{F}$ to +176 $^{\circ}\text{F}$
Thermistor output resolution	0.0625 $^{\circ}\text{C}$ 0.1125 $^{\circ}\text{F}$

*1: fps: frame per second

*2: Normal Mode : normal operation mode

Sleep Mode: detection is off (output and data reading not possible)

Internal circuit

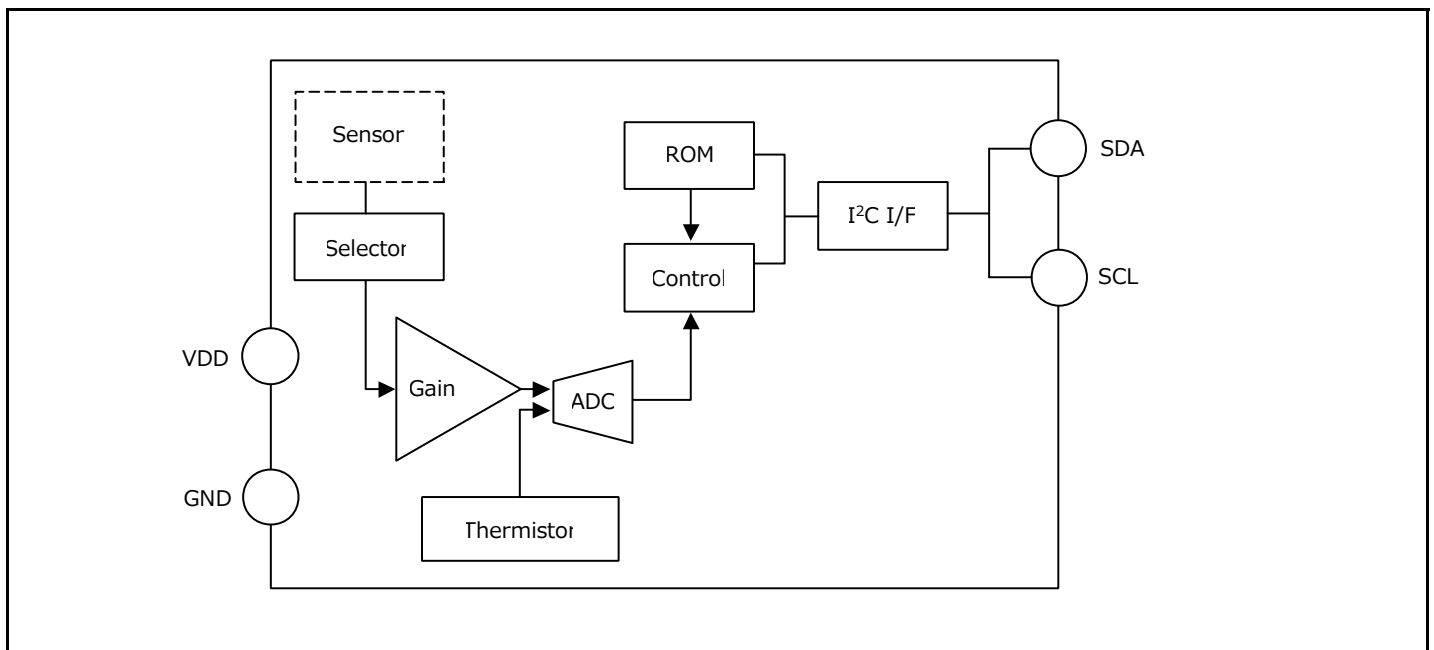

Print board circuit

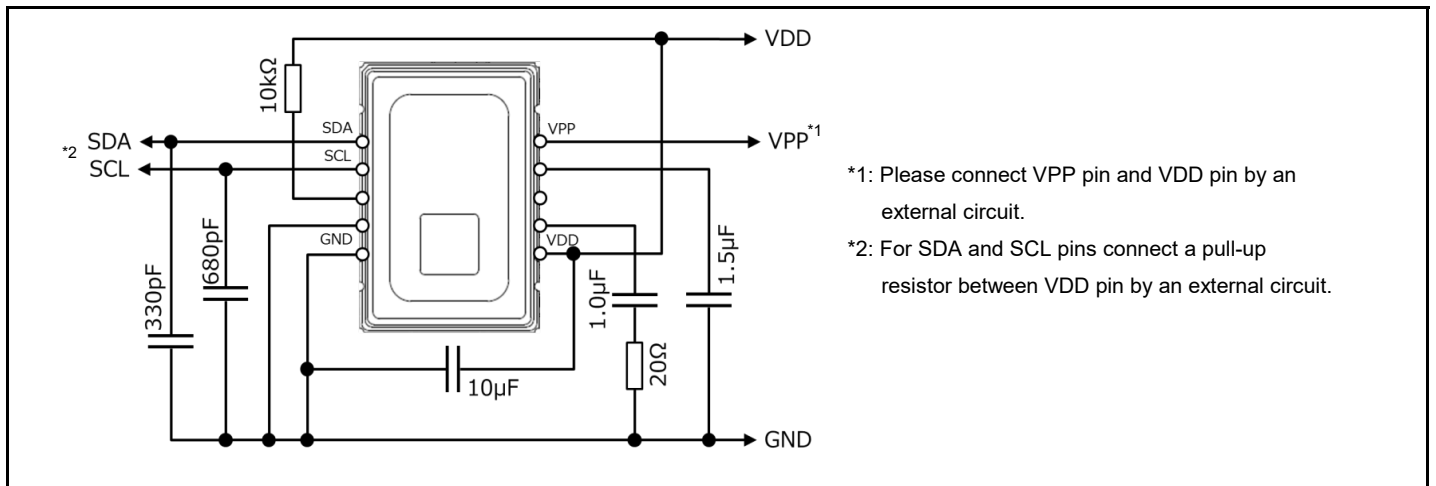

Pixel array and viewing angle

(1) Pixel array

Pixel array from 1 to 64 is shown below.

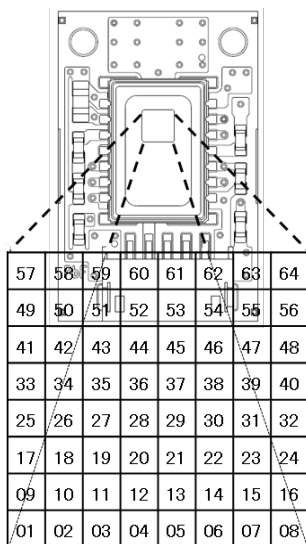

(2) Viewing field

Sensor viewing field (Typ.) is shown below.

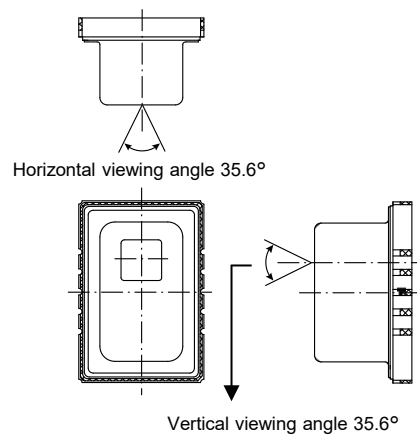

Optical properties

(1) Each pixel's viewing central angle

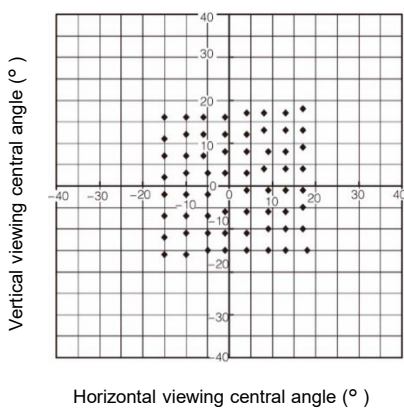

(2) Each pixel's viewing angle (half angle)

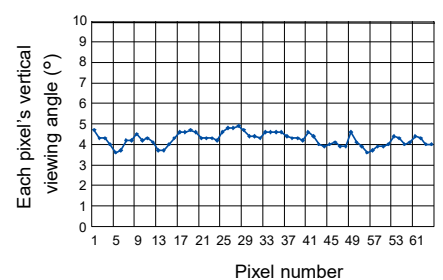
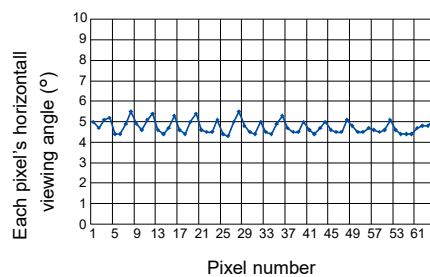

Dimensions

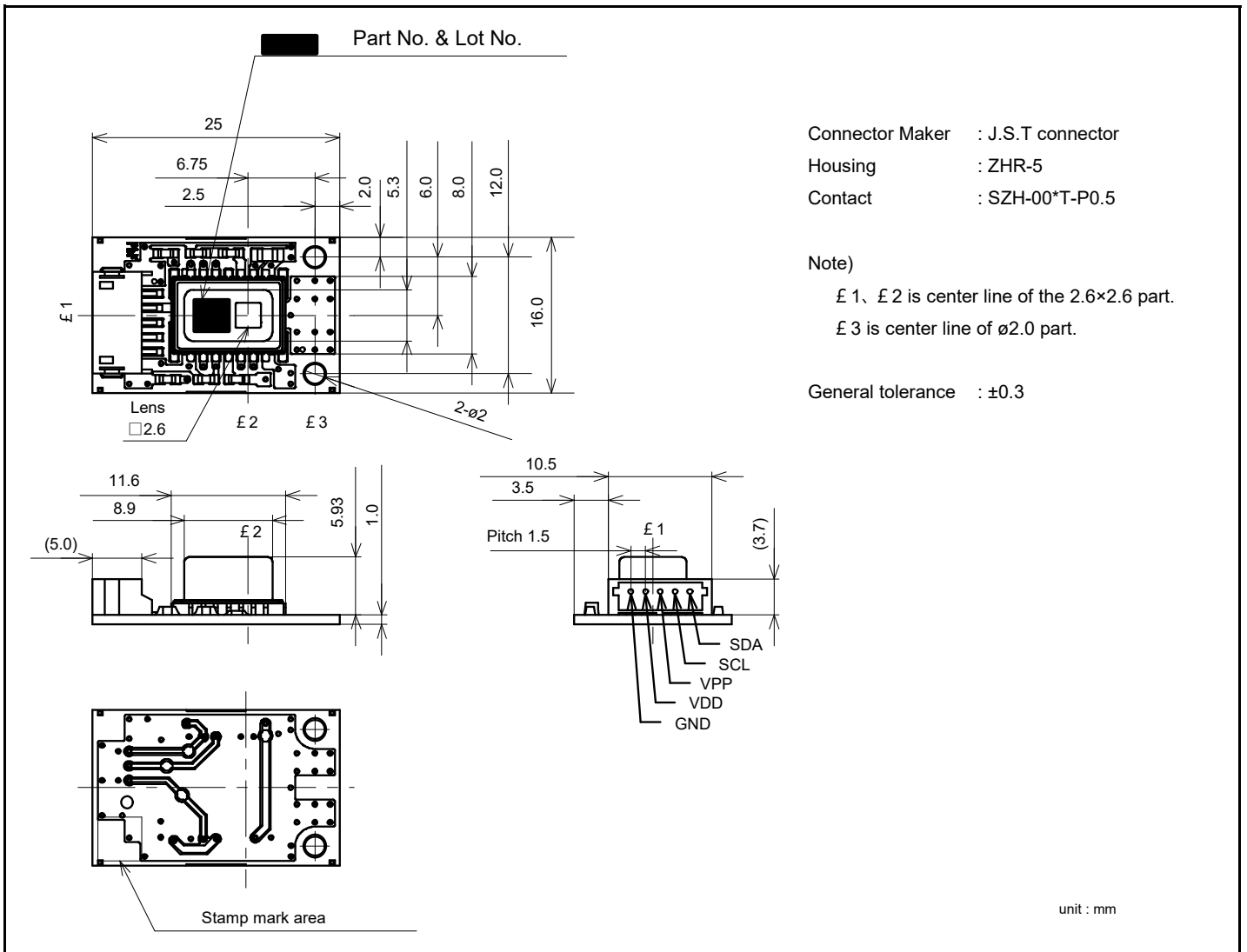

Pressure Sensors

PS-A

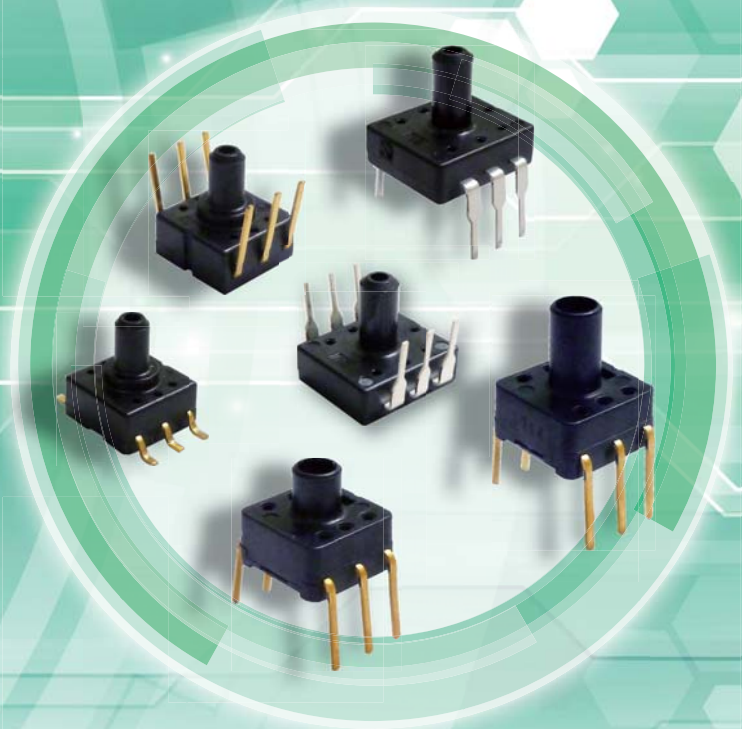

Matters to Be Observed When Using This Product

(Pressure sensor / PS-A)

Use environments and cleaning conditions

- Do not use or store the sensor with a non-air medium, especially in a medium containing a corrosive gas (organic solvent, sulfur dioxide, hydrogen sulfide, etc.), moisture, foreign matter, or the like. Do not use the sensor with a harmful medium, such as a corrosive gas, a combustible gas, or a toxic gas. There is a possibility that a tiny amount of the harmful medium will leak out and exert a harmful effect on the surrounding environment and the human body.
- The sensor does not have a waterproof structure. Avoid using the sensor in a place where water, etc., may splash on the sensor or an environment where dew concentrates on the sensor. When water on the sensor freezes, it may lead to a change in the output from the sensor or even the destruction of the sensor.
- Because of the structural features of the sensor, the sensor output fluctuates when the sensor is exposed to light. Avoid the sensor being exposed to light, etc., especially, when pressure is applied to the sensor through a transparent tube.
- Do not use the sensor in a situation where high-frequency vibrations, such as ultrasonic waves, are applied to the sensor.
- The sensor may malfunction when exposed to static electricity, lightning, or electric noise from a cellular phone, radio transmitter, broadcasting station, etc.
- Since the sensor is open to the ambient air, be careful not to let cleaning solution flow into the sensor. Do not clean the sensor by using ultrasonic waves. It may cause the sensor to fail.

Handling conditions

- Use the sensor in the rated voltage range. Applying voltage outside the rated voltage range to the sensor can cause an accident or breakage of the sensor. Select the way the sensor, lead-in tube, etc., are fixed in accordance with the pressure being applied to the sensor. If you have any question, please feel free to contact us.
- The sensor has a built-in sensor chip located close to the pressure lead-in port. Inserting a foreign object, such as a needle, in the pressure lead-in port damages the chip or blocks up the lead-in port. Never do this. Do not block up the pressure lead-in port.
- When coating the board carrying the sensor with a potting agent, etc., make sure that the potting agent does not go into the pressure lead-in port and the ambient pressure lead-in port. Thermal expansion/shrinkage of a resin coating the sensor applies stress to the sensor. Use a resin with elasticity as a sealing agent (potting agent) after sufficiently evaluating its properties.
- The sensor may be destroyed by static electricity. Keep the sensor in a storage condition in which its terminals are short-circuited via a conductive material or the whole sensor is wrapped with aluminum foil, etc. Because a plastic container becomes charged with static electricity easily, avoid using a plastic container for storage or transportation of the sensor. When using the sensor, let surrounding objects release static electricity safely by grounding the operator, charged objects on the table, etc.

Circuit design and circuit board design

- Connect the sensor in accordance with the terminal connection diagram. Do not connect the sensor in reverse polarity to the power supply or connect a free terminal. Such wiring will lead to breakage or deterioration of the sensor.
- To ensure the sensor's resistance to noise superposed on source voltage, make sure to provide the power input terminals of the sensor with capacitors to stabilize the source voltage. We recommend to dispose a 0.1 μ F capacitor and a 1,000 pF capacitor in parallel with each other. Make sure to select or add an optimum capacitor after confirming the sensor's resistance to noise in the actual circuit configuration where the sensor is provided with the capacitor.
- An external surge voltage applied to the sensor damages its internal circuit. Use a surge absorber to protect the sensor from incoming surges.
- Adopt a printed board with a land wide enough to affix the sensor thereon.

Mounting conditions

- A sensor has a small structure with a small heat capacity. When soldering the sensor, keep the effects of external heat on the sensor as small as possible. A sensor exposed to intensive heat thermally deforms, which may lead to breakage or change in characteristics.
- Use non-corrosive, rosin-based solder flux. The sensor is structured to be open to the ambient air. Make sure that solder flux does not flow into the sensor.
- Perform manual soldering in the following manner: clean the soldering iron tip sufficiently and then finish soldering, with the soldering iron tip heated to 260 °C to 300 °C (30 W), within 5 seconds. Do not apply a load to the sensor terminals. It may change the output from the sensor.
- Perform flow soldering (DIP terminal type) with a flow soldering tank temperature kept at 260 °C or lower and within 5 seconds. When the sensor is mounted on a board with a small heat capacity, the sensor may thermally deform when exposed to soldering heat. In this case, avoid flow soldering.
- In the case of reflow soldering (SMD terminal type), we recommend solder-paste screen printing as a solder paste printing method.
- For a footprint pattern on the printed board, refer to the printed board recommended specification diagram. Because self-alignment of solder is insufficient in some cases, carefully align the terminals of the sensor and the pattern.
- The recommended reflow temperature profile is shown below. The temperature measurement shown in the temperature profile is the value measured at a part of board that is close to the terminals.

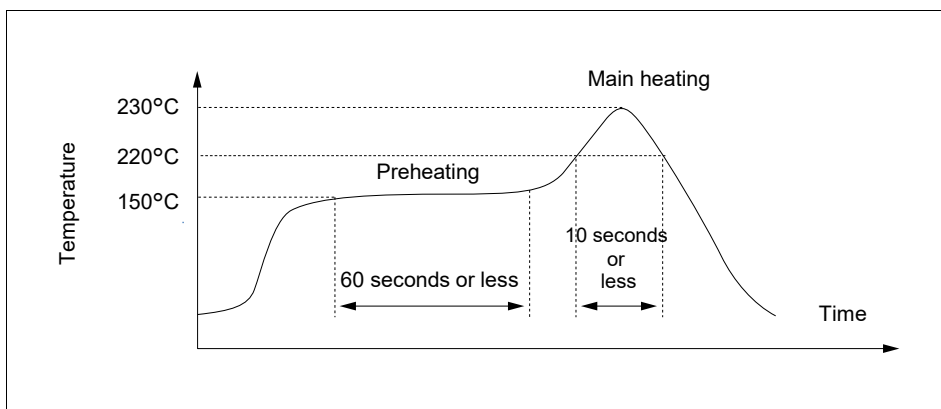

- The front end of the pressure lead-in port may melt or deform under high temperature, depending on the equipment or conditions. Make sure to conduct a confirmation test under the actual mounting conditions.
- Complete rework on a soldered part in a single process. When reworking a solder bridge, use a solder iron with a flat tip and do not apply any additional solder flux. Use a solder iron with a tip temperature equal to or lower than the tip temperature specified in the specification sheet.
- A warped printed board applies stress to the sensor, which may change the characteristics of the sensor. Conduct a characteristics confirmation test after the soldering process. When cutting or folding the board after mounting the sensor on the board, be careful that no stress is applied to the soldered area.
- The sensor has external terminals exposed from its body. A metal piece, etc., coming in contact with the exposed terminals, causes problems with output from the terminals. Prevent metal pieces, bare hands, etc., from coming in contact with the terminals. Excessive force applied to the terminals deforms the terminals, thus impairing the solderability of the sensor. Do not drop the sensor, and do not handle it roughly, either.
- When coating the board to prevent the deterioration of insulation properties after the soldering process, make sure that no chemical sticks to the sensor.

Pressure Sensor

PS-A (ADP5) series

(Built-in amplification and temperature compensating circuit)



Built-in amplifier and compensating circuit

Feature

- Built-in amplifier and temperature compensation circuit, no need for circuit design and characteristic adjustment.
- High accuracy and reliability : overall accuracy $\pm 1.25\%$ FS (Standard), $\pm 2.5\%$ FS (Low-pressure type)
- Compact size, space-saving : compatible size for PS type (Standard/Economy, S and M packages)
- RoHS compliant

Typical applications

- Industrial use : Pressure switches and pneumatic components, compressed air pressure measuring devices
 - Medical use : Airbeds
 - Others : Pressure sensing devices for air pressure mediums
- [Low-pressure type]
- Water level detection for domestic appliances : Washing machines and dishwashers
 - Air pressure control : Cleanrooms and smoking rooms



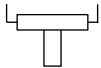
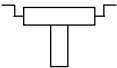

Ordering information

ADP5	1	5	1
Terminal profile	Code	Rated pressure	Code
1 : DIP terminal	0	± 100 kPa	Package/Pressure inlet hole
	1	-100 kPa	S package
2 : SMD terminal	2	25 kPa	length : 3 mm 0.118 inch, dia : 3 mm 0.118 inch
	4	100 kPa	M package
	5	200 kPa	length : 5 mm 0.197 inch, dia : 3 mm 0.118 inch
	6	500 kPa	P package (Only low pressure type)
	7	1000 kPa	length : 15.6 mm 0.615 inch, dia : 5.45 mm 0.215 inch
	B6	6 kPa (Low pressure type)	

Note : Some part numbers may not be available depending on the combination.
Please refer to the Table of PRODUCT TYPES on the next page.

Product types

Standard packing : Carton : 100 pcs.; Case : 1,000 pcs.

Pressure	Terminal	Part No.				
		Standard type		Standard / Economy type		Low pressure type
		S package (3 mm 0.118 inch)		M package (5 mm 0.118 inch)		P package (15.6 mm 0.614 inch)
		DIP terminal 	SMD terminal 	DIP terminal 	SMD terminal 	DIP terminal 
Standard type (with glass base)						
± 100 kPa		ADP5100	ADP5200	ADP5101	ADP5201	—
-100 kPa		ADP5110	ADP5210	ADP5111	ADP5211	—
25 kPa		ADP5120	—	ADP5121	—	—
100 kPa		ADP5140	ADP5240	ADP5141	ADP5241	—
200 kPa		ADP5150	ADP5250	ADP5151	ADP5251	—
500 kPa		ADP5160	ADP5260	ADP5161	ADP5261	—
1000 kPa		ADP5170	ADP5270	ADP5171	ADP5271	—
Low pressure type						
6 kPa		—	—	—	—	ADP51B63

Rating

● Standard type

Item	Standard type (with glass base)						
Type of pressure	Gauge pressure						
Pressure medium	Air ^{*1}						
Rated pressure (kPa)	±100	-100	25	100	200	500	1000
Max. applied pressure	Twice of the rated pressure						1.5 times the rated pressure
Ambient temperature	-10 °C to +60 °C 14 °F to +140 °F (no freezing or condensation)						
Storage temperature	-20 °C to +85 °C -4 °F to +185 °F (no freezing or condensation)						
Drive voltage	5±0.25 V						
Temperature compensation range	0 °C to 50 °C 32 °F to 122 °F						
Offset voltage ^{*2,3,5}	2.5±0.05						0.5±0.05 V
Rated output voltage ^{*2,3,5}	4.5±0.05 (+when +100kPa)						4.5±0.05 V
Overall accuracy	±1.25 %FS ^{*3,4,5}						
Current consumption	Max. 10 mA ^{*2,3}						

*1: Please consult us for pressure media other than dry air, nitrogen, oxygen, carbon dioxide.

*2: Indicates output when temperature is 25 °C 77 °F.

*3: Indicates output when drive voltage is 5 V. Although output fluctuates due to fluctuations in the drive voltage, this is not included.

*4: Overall accuracy indicates the accuracy of the offset voltage and rated output voltage at a temperature compensation range of 0 to 50 °C 32 to 122 °F.

*5: Accuracy is the value at the time of our shipping. Please set Zero-point calibration function on your products in order to safely use if the offset voltage is shifted.

● Low pressure type

Item	Economy type (without glass base)						
Type of pressure	Gauge pressure						
Pressure medium	Air ^{*1}						
Rated pressure (kPa)	6						
Max. applied pressure	Twice of the rated pressure						
Ambient temperature	0 °C to +70 °C 32 °F to +158 °F (no freezing or condensation)						
Storage temperature	-30 °C to +100 °C -22 °F to +212 °F (no freezing or condensation)						
Drive voltage	5±0.25 V						
Temperature compensation range	0 °C to 70 °C 32 °F to 158 °F						
Offset voltage	0.5 V (Typical) ^{*2}						
Span voltage	4.0 V (Typical) ^{*2}						
Overall accuracy	±2.5 %FS ^{*2,3,4}						
Current consumption	Max. 10 mA						

*1: Please consult us for pressure media other than dry air, nitrogen, oxygen, carbon dioxide.

*2: Indicates output when drive voltage is 5 V. Although output fluctuates due to fluctuations in the drive voltage, this is not included.

*3: Overall accuracy indicates the accuracy of the offset voltage and span voltage at temperatures between 0 to 70 °C 32 to 158 °F (FS=4V)

*4: The initial offset voltage error is not included in the overall accuracy.

Reference data

[Standard type]

1. - ① Output voltage

(Representative example : ADP5170)
 Drive voltage : 5 V
 Temperature : 25 °C 77 °F
 Applied pressure : 0 to +1,000 kPa

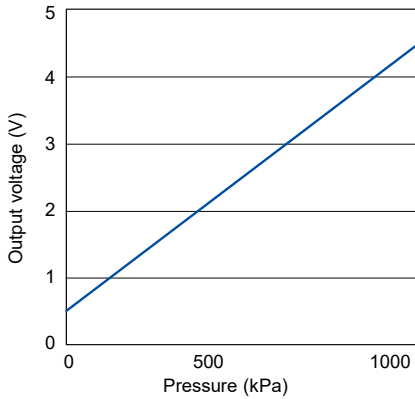

1. - ② Overall accuracy (Offset voltage)

(Representative example : ADP5170)
 Drive voltage : 5 V
 Temperature : 0 to 50 °C 32 to 122 °F
 Applied pressure : 0 kPa

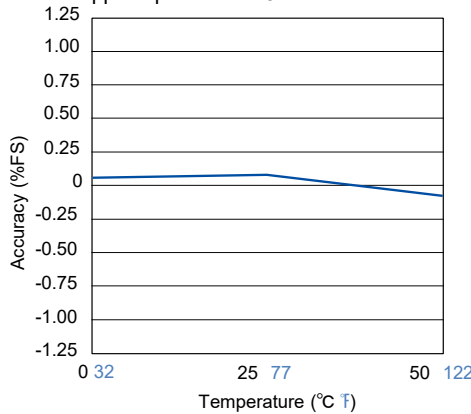

1. - ③ Overall accuracy (Rated output voltage)

(Representative example : ADP5170)
 Drive voltage : 5 V
 Temperature : 0 to 50 °C 32 to 122 °F
 Applied pressure : +1,000 kPa

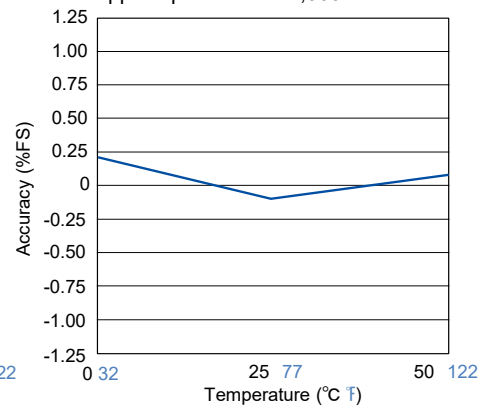

2. - ① Output voltage

(Representative example : ADP5100)
 Drive voltage : 5 V
 Temperature : 25 °C 77 °F
 Applied pressure : -100 to +100 kPa

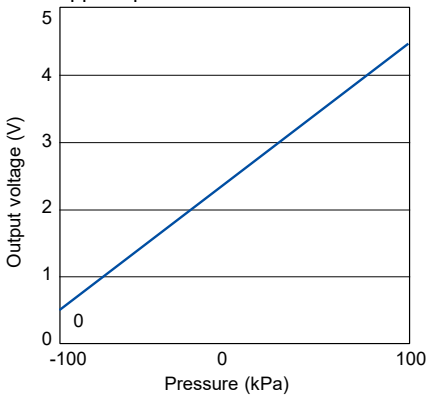

2. - ② Overall accuracy (Offset voltage)

(Representative example : ADP5100)
 Drive voltage : 5 V
 Temperature : 0 to 50 °C 32 to 122 °F
 Applied pressure : 0 kPa

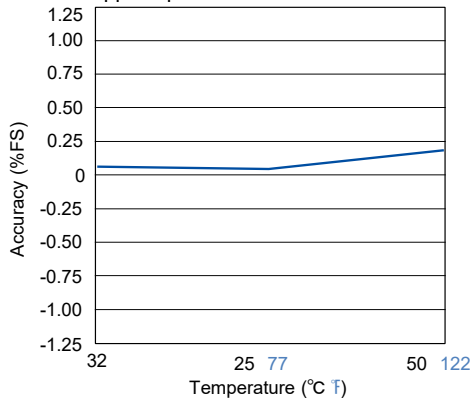

2. - ③ Overall accuracy (Rated output voltage)

(Representative example : ADP5100)
 Drive voltage : 5 V
 Temperature : 0 to 50 °C 32 to 122 °F
 Applied pressure : +100 kPa

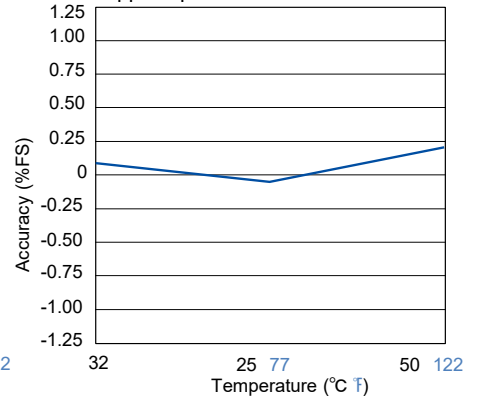

Reference data

[Low pressure type]

1. Output voltage

(ADP51B63)

Drive voltage : 5 V

Temperature : 25 °C 77 °F

Applied pressure : 0 to 6 kPa

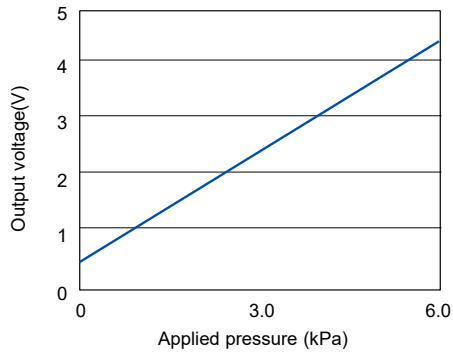

2. THB (high temperature high humidity bias test)

(ADP51B63)

Within 85 °C 185 °F and 85% RH

5 V applied between No.2 (Vdd) and No.3 (GND)

Applied pressure : 0 kPa

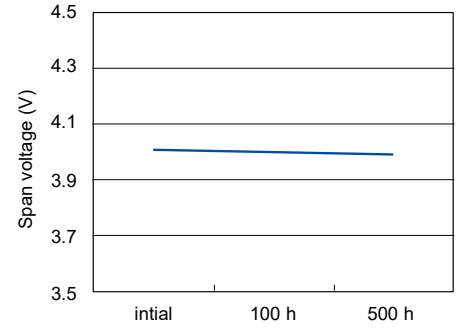
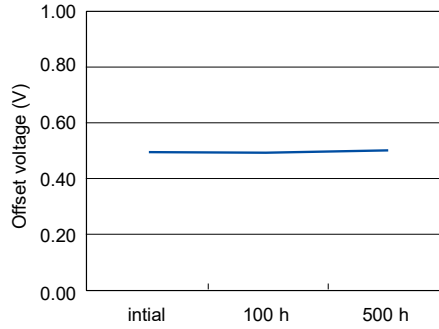

3. Ambient temperature characteristics (ADP51B63)

Ambient temperature : 25 °C 77 °F → 0 °C 32 °F → 10 °C 50 °F → 60 °C 140 °F → 70 °C 158 °F

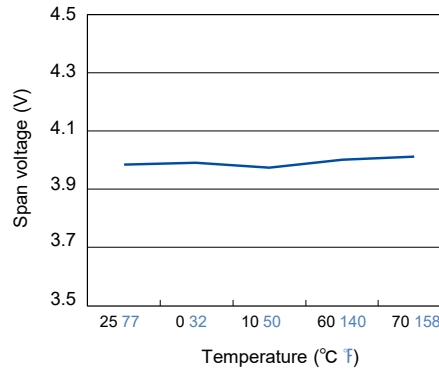
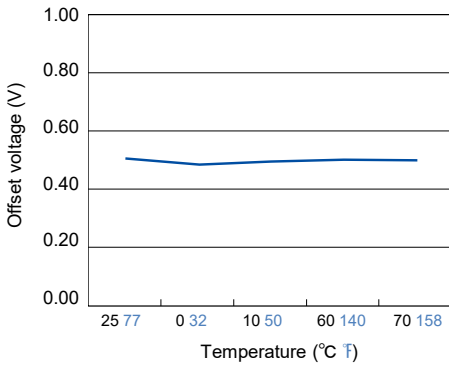

4. Shock test

(ADP51B63)

Shock applied (981 m/s², 3 times in x, y and z directions)

Applied pressure : 0 kPa

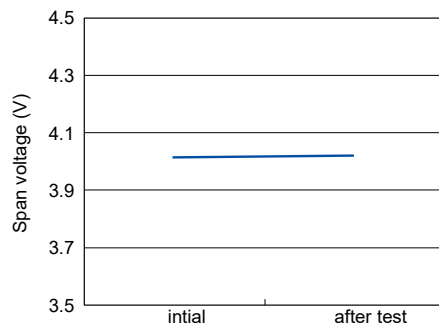
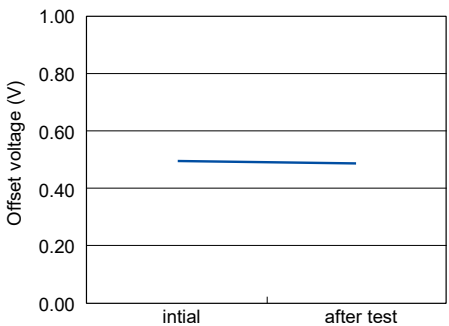

5. Vibration test

(ADP51B63)

Vibration applied (10 to 55 Hz, amplitude : 1.5mm, x, y and z directions, 2 hrs each)

Applied pressure : 0 kPa

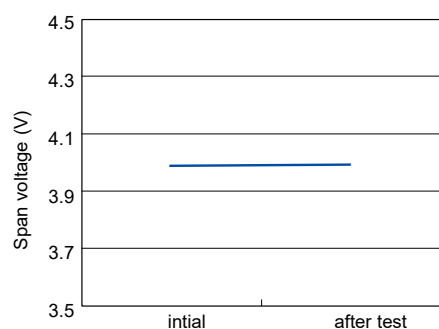
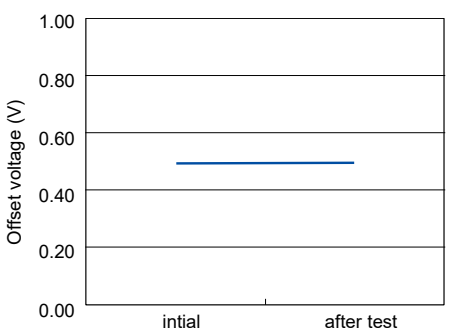

Reference data

6. Temperature/humidity cycle test
(ADP51B63)

Exposed to 10 cycles in the temperature and humidity conditions given below.
Applied pressure : 0 kPa

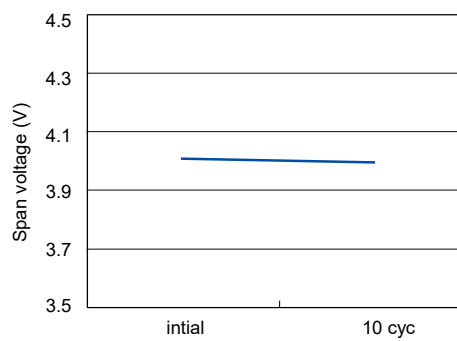
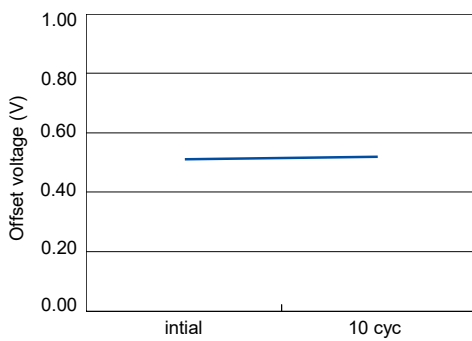
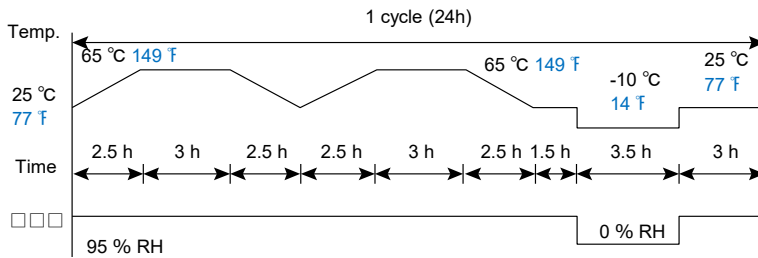

Evaluation test

Classification	Tested item	Tested condition	Result
Environmental characteristics	Storage at high temperature	Temperature : Left in a 85 °C 185 °F constant temperature bath Time : 100 hrs	Passed
	Storage at low temperature	Temperature : Left in a -20 °C -4 °F constant temperature bath Time : 100 hrs	Passed
	Humidity	Temperature/humidity : Left at 40 °C 104 °F, 90 % RH Time : 100 時間	Passed
	Temperature cycle	Temperature : -20 °C to 85 °C -4 °F to 185 °F 1 cycle : 30 min Times of cycle : 100 cycle	Passed
Endurance characteristics	High temperature/high humidity operation	Temperature/humidity : 40 °C 104 °F, 90% RH Operation times : 10 ⁶ , rated voltage applied	Passed
Mechanical characteristics	Vibration resistance	Double amplitude : 1.5 mm 0.059 inch Vibration : 10 to 55 Hz Applied vibration direction : X, Y, Z 3 directions Time : 2 hrs each	Passed
	Dropping resistance	Dropping height : 75 cm 29.528 inch Times : 2 times	Passed
	Terminal strength	Pulling strength : 9.8 N {1 kgf}, 10 sec Bending strength : 4.9 N {0.5 kgf}, left and right 90 ° 1 time	Passed
Soldering characteristics	Solderability	Temperature : 230 °C 446 °F Time : 5 sec	Passed
	Heat resistance (DIP)	Temperature : 260 °C 500 °F Time : 10 sec	Passed

Note: For details other than listed above, please consult us.

Items	Criteria
Offset voltage	Variation amount
Output span voltage	within ±2.5 %FS of value

Dimensions

The CAD data of the products with a **CAD data** mark can be downloaded from: <http://industrial.panasonic.com/>

- Standard type S package (Terminal direction : DIP terminal Pressure inlet hole length : 3 mm 0.118 inch) ADP51□0

CAD data

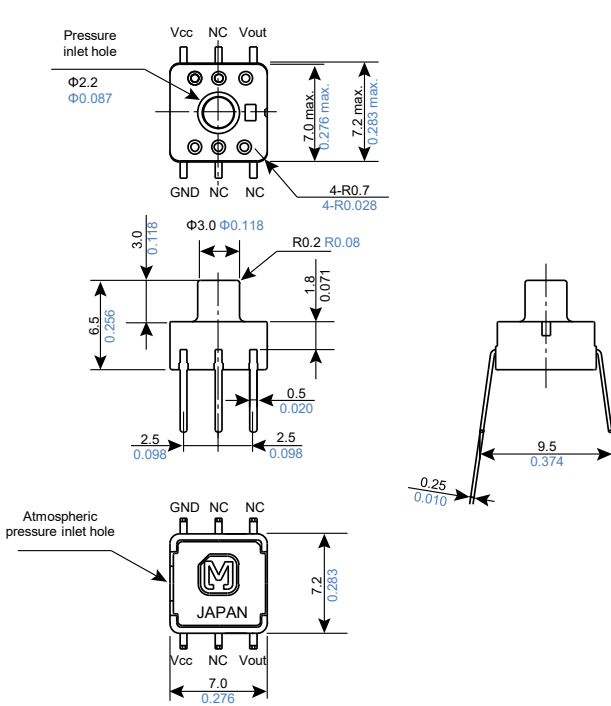

Recommended PC board pattern (TOP VIEW)

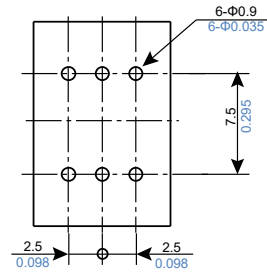

Terminal connection diagram

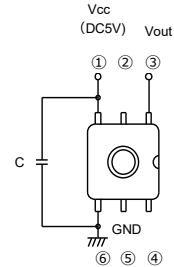

Terminal No.	Name
1	Vcc (Power supply ⊕)
2	NC (No connection)
3	Vout (Output)
4	NC (No connection)
5	NC (No connection)
6	GND (Ground)

Note: leave terminal "No connection" unconnected.

Unit : mm inch, General tolerance ±0.3 ±0.012

- Standard type S package (Terminal direction : SMD terminal Pressure inlet hole length : 3 mm 0.118 inch) ADP52□0

CAD data

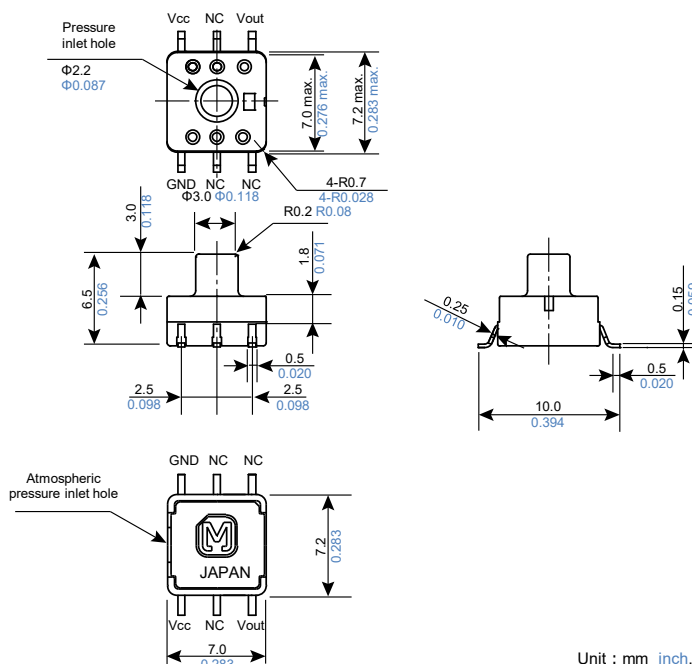

Recommended PC board pattern (TOP VIEW)

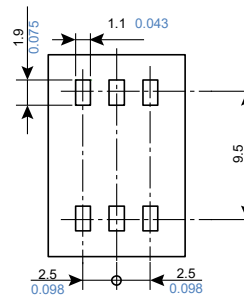

Terminal connection diagram

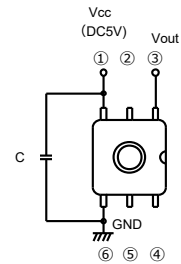

Terminal No.	Name
1	Vcc (Power supply ⊕)
2	NC (No connection)
3	Vout (Output)
4	NC (No connection)
5	NC (No connection)
6	GND (Ground)

Note: leave terminal "No connection" unconnected.

Unit : mm inch, General tolerance ±0.3 ±0.012

Dimensions

The CAD data of the products with a **CAD data** mark can be downloaded from: <http://industrial.panasonic.com/>

- Standard/Economy type M package (Terminal direction : DIP terminal Pressure inlet hole length : 5 mm 0.197 inch) ADP51□1

ADP51□1/ADP51A11

CAD data

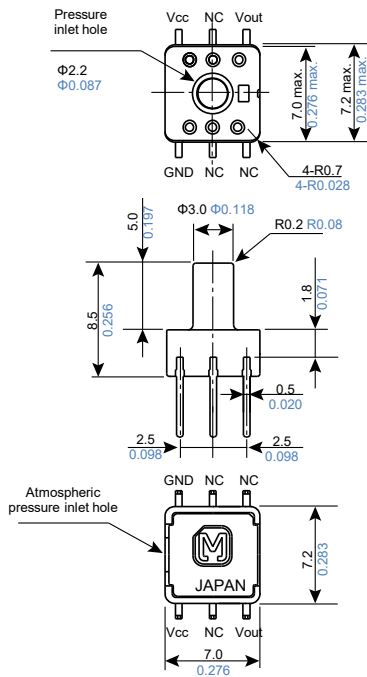

Recommended PC board pattern (TOP VIEW)

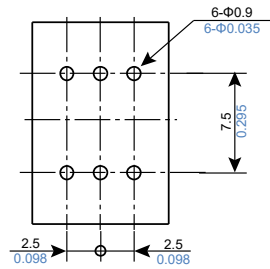

Terminal connection diagram

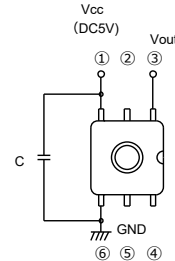

Terminal No.	Name
1	Vcc (Power supply ⊕)
2	NC (No connection)
3	Vout (Output)
4	NC (No connection)
5	NC (No connection)
6	GND (Ground)

Note: leave terminal "No connection" unconnected.

Unit : mm inch, General tolerance ±0.3 ±0.012

- Standard/Economy type M package (Terminal direction : SMD terminal Pressure inlet hole length : 5 mm 0.197 inch) ADP52□1

CAD data

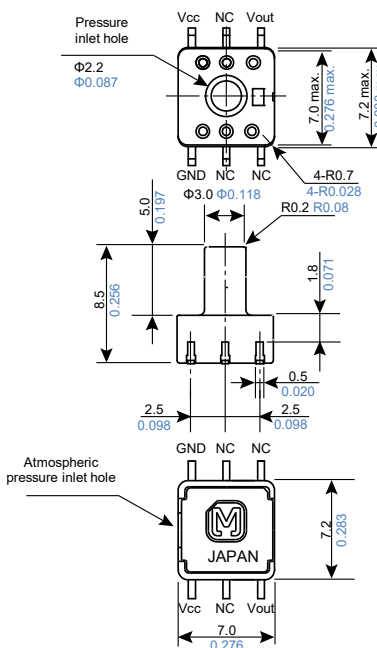

Recommended PC board pattern (TOP VIEW)

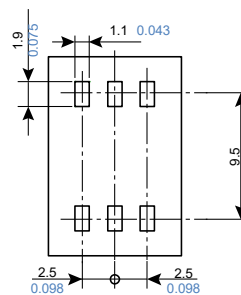

Terminal connection diagram

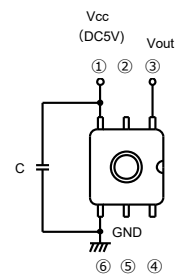

Terminal No.	Name
1	Vcc (Power supply ⊕)
2	NC (No connection)
3	Vout (Output)
4	NC (No connection)
5	NC (No connection)
6	GND (Ground)

Note: leave terminal "No connection" unconnected.

Unit : mm inch, General tolerance ±0.3 ±0.012

Dimensions

The CAD data of the products with a **CAD data** mark can be downloaded from: <http://industrial.panasonic.com/>

- Low pressure type P package (Terminal direction : DIP terminal, Pressure inlet hole length : 15.6 mm 0.614 inch) ADP51B63

CAD data

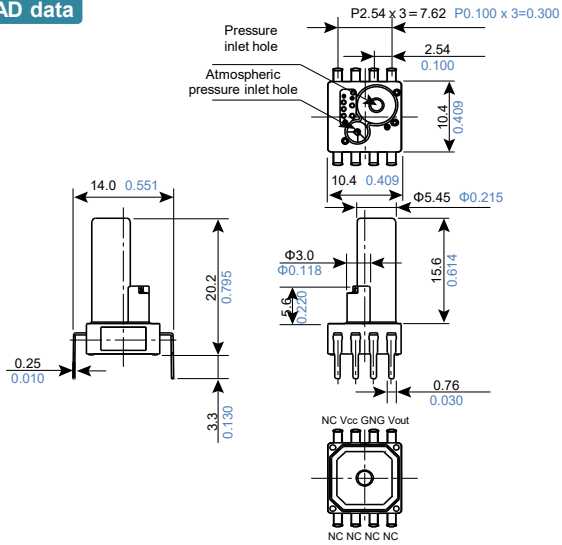

Recommended PC board pattern (BOTTOM VIEW)

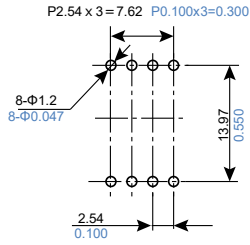

Terminal connection diagram

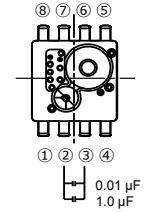

Unit : mm inch, General tolerance $\pm 0.3 \pm 0.012$

Terminal No.	Name
1	NC (No connection)
2	Vcc (Power supply [⊕])
3	GND (Ground)
4	Vout (Output)

Terminal No.	Name
5	NC (No connection)
6	NC (No connection)
7	NC (No connection)
8	NC (No connection)

Note: leave terminal "No connection" unconnected.

Pressure Sensors

PS / PF

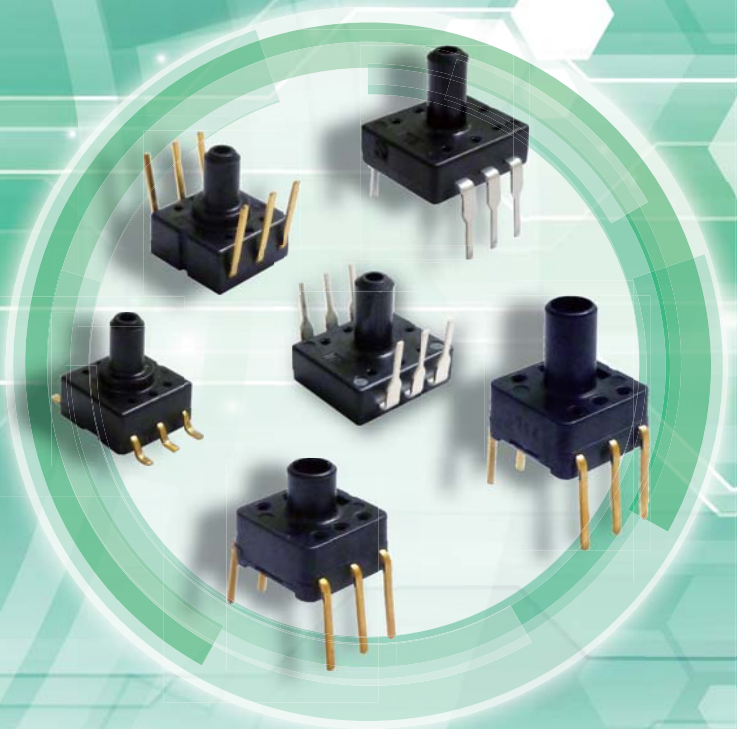

Matters to Be Observed When Using This Product

(Pressure sensor / PS-PF)

Use environments and cleaning conditions

- Do not use or store the sensor with a non-air medium, especially in a medium containing a corrosive gas (organic solvent, sulfur dioxide, hydrogen sulfide, etc.), moisture, foreign matter, or the like. Do not use the sensor with a harmful medium, such as a corrosive gas, a combustible gas, or a toxic gas. There is a possibility that a tiny amount of the harmful medium will leak out and exert a harmful effect on the surrounding environment and the human body.
- The sensor does not have a waterproof structure. Avoid using the sensor in a place where water, etc., may splash on the sensor or an environment where dew concentrates on the sensor. When water on the sensor freezes, it may lead to a change in the output from the sensor or even the destruction of the sensor.
- Because of the structural features of the sensor, the sensor output fluctuates when the sensor is exposed to light. Avoid the sensor being exposed to light, etc., especially, when pressure is applied to the sensor through a transparent tube.
- Do not use the sensor in a situation where high-frequency vibrations, such as ultrasonic waves, are applied to the sensor.
- The sensor may malfunction when exposed to static electricity, lightning, or electric noise from a cellular phone, radio transmitter, broadcasting station, etc.
- Since the sensor is open to the ambient air, be careful not to let cleaning solution flow into the sensor. Do not clean the sensor by using ultrasonic waves. It may cause the sensor to fail.

Handling conditions

- Use the sensor in the rated voltage range. Applying voltage outside the rated voltage range to the sensor can cause an accident or breakage of the sensor. Select the way the sensor, lead-in tube, etc., are fixed in accordance with the pressure being applied to the sensor. If you have any question, please feel free to contact us.
- The sensor has a built-in sensor chip located close to the pressure lead-in port. Inserting a foreign object, such as a needle, in the pressure lead-in port damages the chip or blocks up the lead-in port. Never do this. Do not block up the pressure lead-in port.
- When coating the board carrying the sensor with a potting agent, etc., make sure that the potting agent does not go into the pressure lead-in port and the ambient pressure lead-in port. Thermal expansion/shrinkage of a resin coating the sensor applies stress to the sensor. Use a resin with elasticity as a sealing agent (potting agent) after sufficiently evaluating its properties.
- The sensor may be destroyed by static electricity. Keep the sensor in a storage condition in which its terminals are short-circuited via a conductive material or the whole sensor is wrapped with aluminum foil, etc. Because a plastic container becomes charged with static electricity easily, avoid using a plastic container for storage or transportation of the sensor. When using the sensor, let surrounding objects release static electricity safely by grounding the operator, charged objects on the table, etc.

Circuit design and circuit board design

- The sensor has its resistance gauge driven by constant current, converting the pressure into corresponding voltage, which is then amplified on a necessary basis. In general, the air pressure transmission method for low-pressure is different from that for high-pressure. The following diagrams show a typical circuit and an air pressure transmission method that are generally adopted.

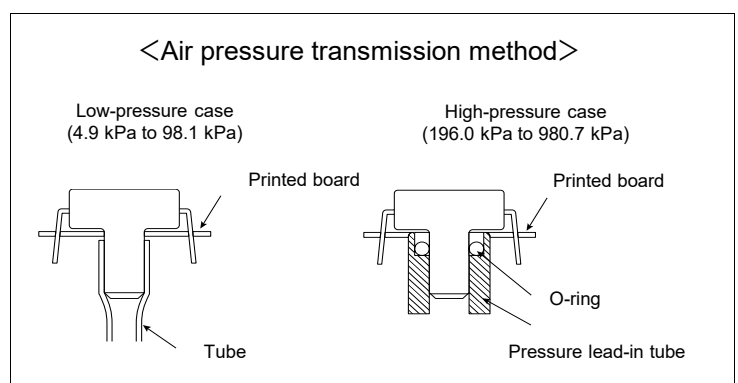
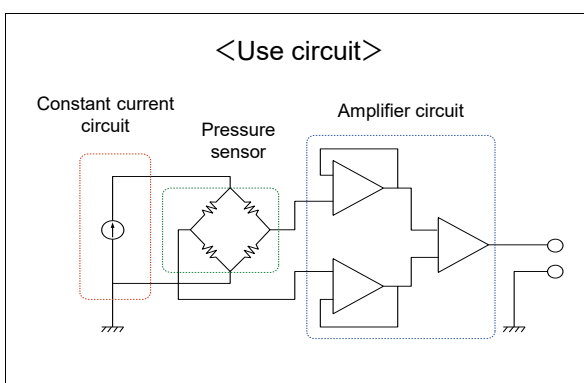

- Adopt a printed board land where the sensor can be affixed properly. Select a solid pressure lead-in tube and fix the sensor firmly so that no pressure leaks. Do not block the pressure lead-in tube.
- In the high-pressure method, the tube may come off due to incoming high pressure. In this case, attach a solid lead-in tube to the sensor with an O-ring interposed therebetween.

Mounting conditions

- A sensor has a small structure with a small heat capacity. When soldering the sensor, keep the effects of external heat on the sensor as small as possible. A sensor exposed to intensive heat thermally deforms, which may lead to breakage or change in characteristics.
- Use non-corrosive, rosin-based solder flux. The sensor is structured to be open to the ambient air. Make sure that solder flux does not flow into the sensor.
- Perform manual soldering in the following manner: clean the soldering iron tip sufficiently and then finish soldering, with the soldering iron tip heated to 260 °C to 300 °C (30 W), within 5 seconds. Do not apply a load to the sensor terminals. It may change the output from the sensor.
- Perform flow soldering (DIP terminal type) with a flow soldering tank temperature kept at 260 °C or lower and within 5 seconds. When the sensor is mounted on a board with a small heat capacity, the sensor may thermally deform when exposed to soldering heat. In this case, avoid flow soldering.
- In the case of reflow soldering (SMD terminal type), we recommend solder-paste screen printing as a solder paste printing method.
- For a footprint pattern on the printed board, refer to the printed board recommended specification diagram. Because self-alignment of solder is insufficient in some cases, carefully align the terminals of the sensor and the pattern.
- The recommended reflow temperature profile is shown below. The temperature measurement shown in the temperature profile is the value measured at a part of board that is close to the terminals.

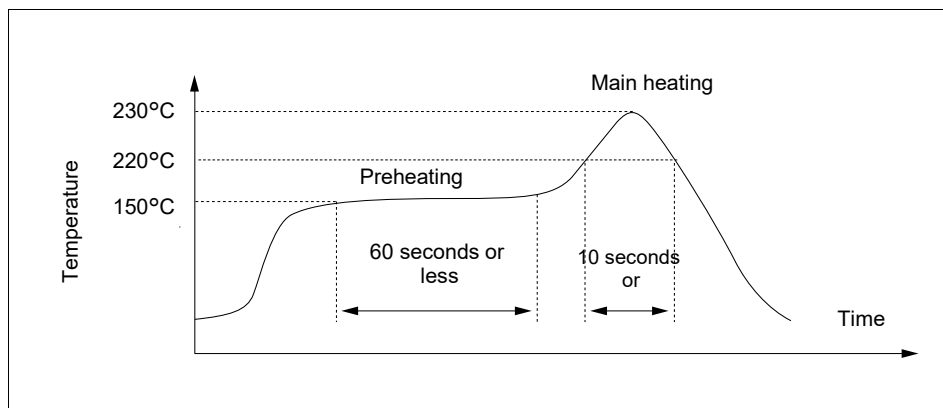

- The front end of the pressure lead-in port may melt or deform under high temperature, depending on the equipment or conditions. Make sure to conduct a confirmation test under the actual mounting conditions.
- Complete rework on a soldered part in a single process. When reworking a solder bridge, use a solder iron with a flat tip and do not apply any additional solder flux. Use a solder iron with a tip temperature equal to or lower than the tip temperature specified in the specification sheet.
- A warped printed board applies stress to the sensor, which may change the characteristics of the sensor. Conduct a characteristics confirmation test after the soldering process. When cutting or folding the board after mounting the sensor on the board, be careful that no stress is applied to the soldered area.
- The sensor has external terminals exposed from its body. A metal piece, etc., coming in contact with the exposed terminals, causes problems with output from the terminals. Prevent metal pieces, bare hands, etc., from coming in contact with the terminals. Excessive force applied to the terminals deforms the terminals, thus impairing the solderability of the sensor. Do not drop the sensor, and do not handle it roughly, either.
- When coating the board to prevent the deterioration of insulation properties after the soldering process, make sure that no chemical sticks to the sensor.

Pressure Sensor

PS (ADP4) series

PF (ADP1) series

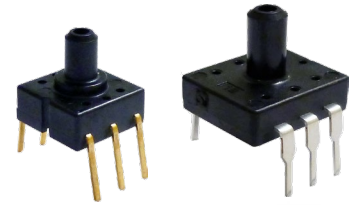

High precision pressure sensor (without amp.)

Feature

- Compact size (PS type)
- High accuracy and liner characteristic
- Broad line-up
- RoHS compliant

Typical applications

- Industrial use : Pressure switches and pneumatic components, compressed air pressure measuring devices and airbeds
- Medical use : Airbeds
- Others : Pressure sensing devices for air pressure mediums

Ordering information

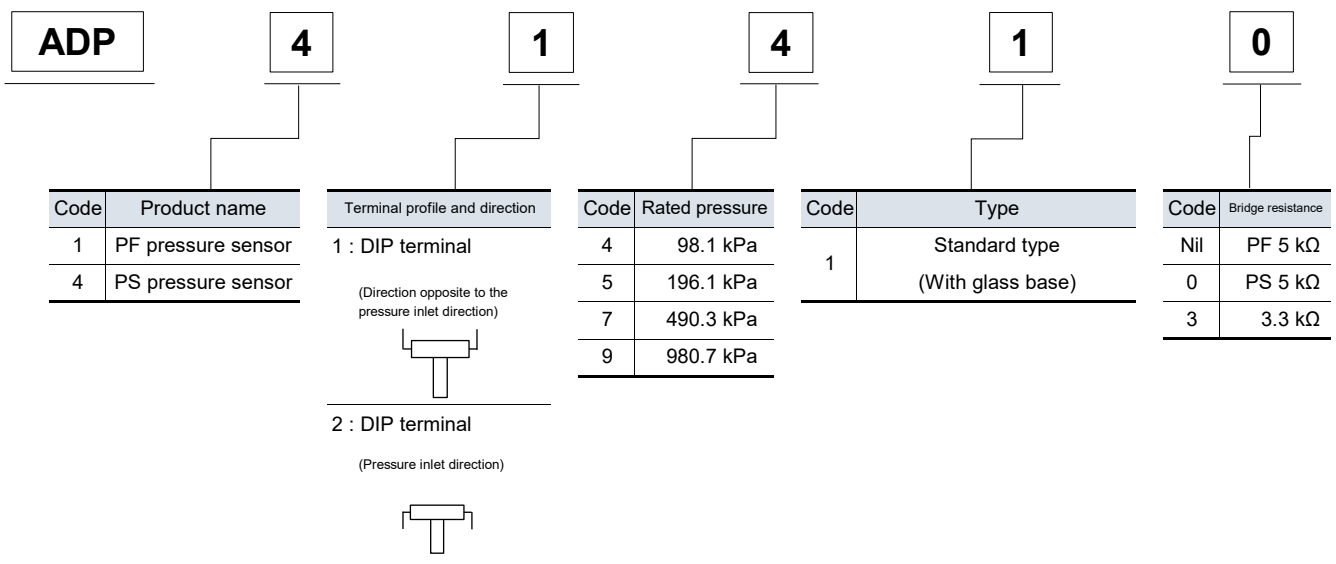

Product types

Standard packing : Carton : 100 pcs.; Case : 1,000 pcs.

		Part No.						
		PS pressure sensor				PF pressure sensor		
		5 kΩ		3.3 kΩ		5 kΩ		
Pressure	Terminal							
		DIP terminal: Direction opposite to the pressure inlet direction	DIP terminal: Pressure inlet direction	SMD terminal	DIP terminal: Direction opposite to the pressure inlet direction	DIP terminal: Pressure inlet direction	DIP terminal: Direction opposite to the pressure inlet direction	DIP terminal: Pressure inlet direction
Standard type (with glass base)								
98.1 kPa		ADP41410	ADP42410	ADP4932	ADP41413	ADP42413	ADP1141	ADP1241
196.1 kPa		ADP41510	ADP42510	—	—	—	ADP1151	ADP1251
490.3 kPa		ADP41710	ADP42710	—	—	—	ADP1171	ADP1271
980.7 kPa		ADP41910	ADP42910	ADP4933	ADP41913	ADP42913	ADP1191	ADP1291

Rating

Type	Standard type (With glass base)				
Type of pressure	Gauge pressure				
Pressure medium	Air ^{*1}				
Rated pressure (kPa)	98.1, 196.1	490.3	980.7	98.1 ^{*2}	980.7 ^{*2}
Max. applied pressure	Twice of the rated pressure		1.5 times of the rated pressure	Twice of the rated pressure	1.5 times of the rated pressure
Bridge resistance	5,000 Ω ± 1,000 Ω			3,300 Ω ± 700 Ω	
Ambient temperature	-20 °C to +100 °C -4 °F to +212 °F (no freezing or condensation)				
Storage temperature	-40 °C to +120 °C -40 °F to +248 °F (no freezing or condensation)				
Standard temperature	25 °C 77 °F			30 °C 86 °F	
Temperature compensation range	0 °C to 50 °C 32 °F to +122 °F			0 °C to 60 °C 32 °F to +140 °F	
Drive current (constant current)	1.5 mA			1.0 mA	
Output span voltage	100 ± 40 mV			65 ± 25 mV	
Offset voltage	±20 mV				
Linearity	±0.3 %FS	±0.5 %FS	±0.6 %FS	±1.0 %FS	
Pressure hysteresis	±0.2 %FS	±0.4 %FS			±1.0 %FS
Offset voltage-temperature characteristics ^{*3}	±5.0 %FS			±3.5 %FS	
Sensitivity-temperature characteristics ^{*3}	±2.5 %FS				

*1: Please consult us for pressure media other than dry air, nitrogen, oxygen, carbon dioxide.

*2: For PS pressure sensor only

*3: This is the regulation which applies within the compensation temperature range.

◆ Unless otherwise specified, measurements were taken with a drive current of ±0.01 mA and humidity ranging from 25% to 85%.

◆ Please consult us if the intended use involves a negative pressure.

Reference data

[PS pressure sensor]

● Characteristics data

1.-(1) Output characteristics

(Representative example : ADP41913)

Drive current : 1.0 mA

Temperature : 30 °C 86 °F

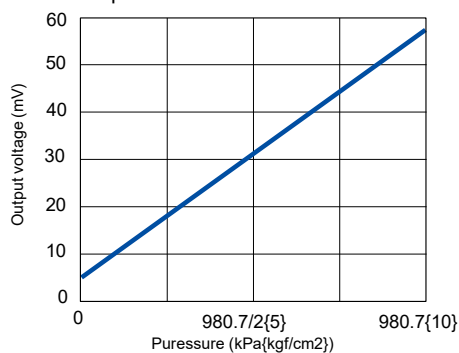

1.-(2) Offset voltage - temperature characteristics

(Representative example : ADP41913)

Drive current : 1.0 mA

Rating : ±3.5 % FS

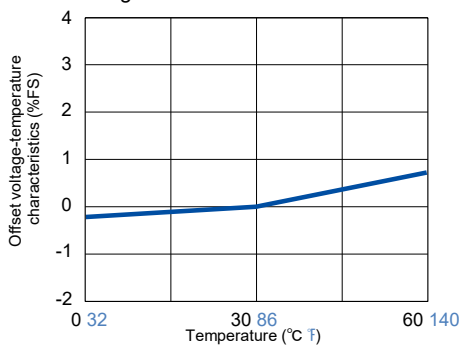

1.-(3) Sensitivity -temperature characteristics

(Representative example : ADP41913)

Drive current : 1.0 mA

Rating : ±2.5 % FS

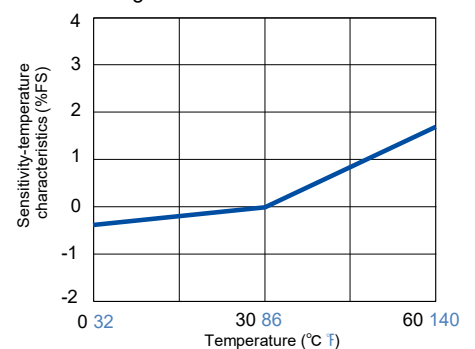

● Pressure cycle range (0 to rated pressure)

(Representative example : ADP41913)

Temperature : 100 °C 212 °F, No. of cycle: 1 × 10⁶

Offset voltage range

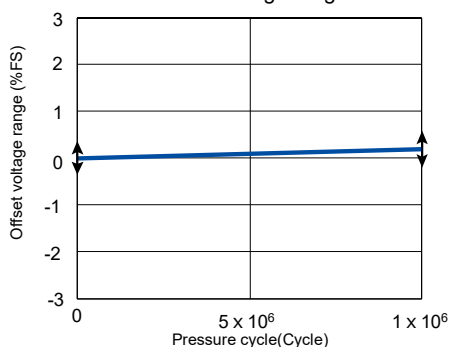

(Representative example : ADP41913 Even after testing for 1 million times,

the variations in the offset voltage

and output span voltage

are minimal.

Output span voltage range

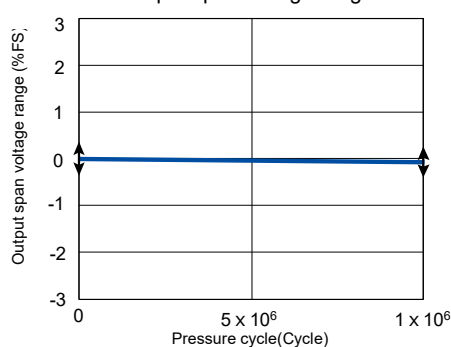

Reference data

[PF pressure sensor]

● Characteristics data

1. - ① Output characteristics

(Representative example : ADP1141)

Drive current : 1.5 mA

Temp. : 25 °C 77 °F

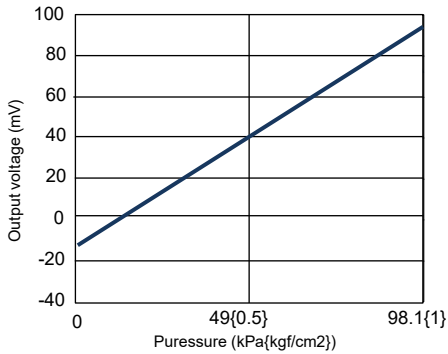

1. - ② Offset voltage - temperature characteristics

(Representative example : ADP1141)

Drive current : 1.5 mA

Rating : ±5 % FS

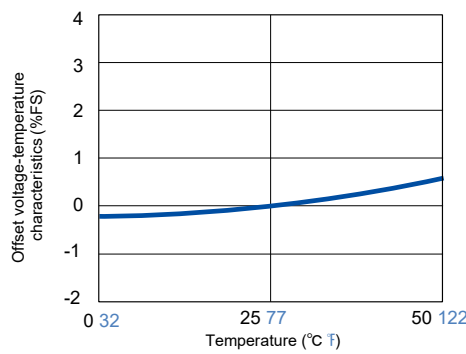

1. - ③ Sensitivity - temperature characteristics

(Representative example : ADP1141)

Drive current : 1.5 mA

Rating : ±2.5% FS

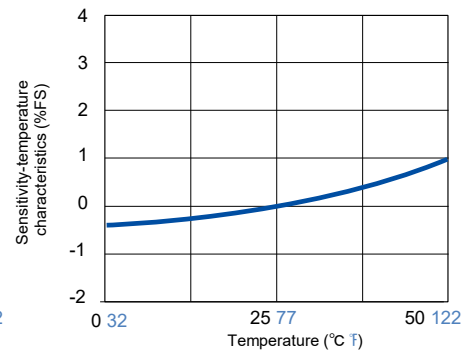

● Pressure cycle range (0 to rated pressure)

(Representative example : ADP1141)

Temperature : 25 °C 77 °F

Offset voltage range

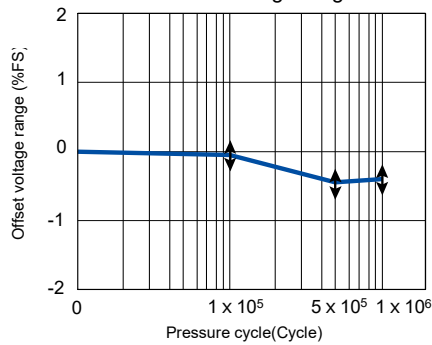

(Representative example : ADP1141)

Output span voltage range

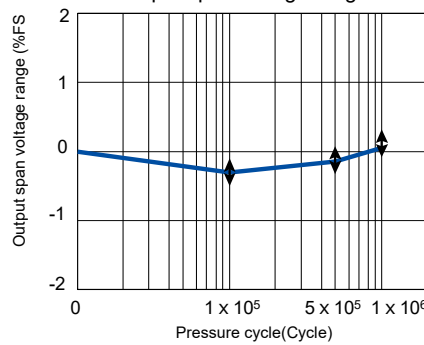

Even after testing for 1 million times, the variations in the offset voltage and output span voltage are minimal.

Evaluation test

Classification	Tested item	Tested condition	Result
Environmental characteristics	Storage at high temperature	Temperature : Left in a 120 °C 248 °F constant temperature bath Time : 1000 h	Passed
	Storage at low temperature	Temperature : Left in a -40 °C -40 °F constant temperature bath Time : 1000 h	Passed
	Humidity	Temperature/humidity : Left at 40 °C 104 °F, 90 % RH Time : 1000 h	Passed
	Temperature cycle	Temperature : -40 °C to 120 °C -40 °F to 248 °F 1 cycle : 30 Min. Times of cycle : 100	Passed
Endurance characteristics	High temperature/ high humidity operation	Temperature/humidity : 40 °C 104 °F, 90% RH Operation times : 10 ⁶ , rated voltage applied.	Passed
Mechanical characteristics	Vibration resistance	Double amplitude : 1.5 mm 0.059 inch Vibration : 10 ~ 55 Hz Applied vibration direction : X, Y, Z 3 directions Time : 2 hrs each	Passed
	Dropping resistance	Dropping height : 75 cm Times : 2 times	Passed
	Terminal strength	Pulling strength : 9.8 N {1 kgf}, 10 sec. Bending strength : 4.9 N {0.5 kgf}, left and right 90 ° 1 time	Passed
Soldering characteristics	Solderability	Temperature : 230 °C 446 °F Time : 5 sec	Passed
	Heat resistance (DIP)	Temperature : 260 °C 500 °F Time : 10 sec	Passed

Note: For details other than listed above, please consult us.

Items	Criteria
Offset voltage	Variation amount
Output span voltage	within ±5.0 %FS of value

Dimensions

The CAD data of the products with a **CAD data** mark can be downloaded from: <http://industrial.panasonic.com/>

[PS pressure sensor]

● Terminal direction : DIP terminal Direction opposite to the pressure inlet direction ADP41□□□

CAD data

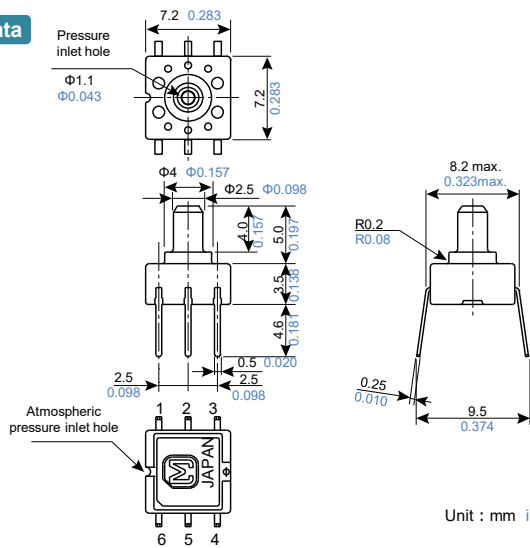

Recommended PC board pattern (BOTTOM VIEW)

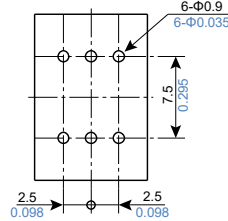

Terminal connection diagram

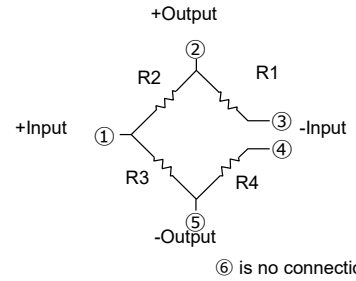

Terminal No.	Name
1	Power supply (+)
2	Output (+)
3	Power supply (-)
4	Power supply (-)
5	Output (-)
6	NC (No connection)

Note: Leave terminal 6 unconnected.

● Terminal direction : DIP terminal Pressure inlet direction ADP42□□□

CAD data

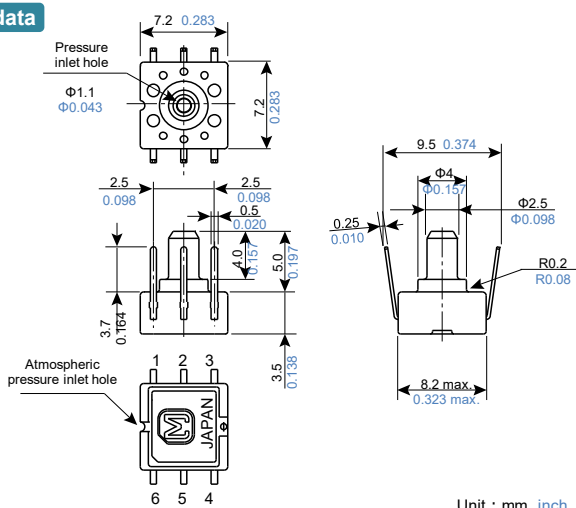

Recommended PC board pattern (BOTTOM VIEW)

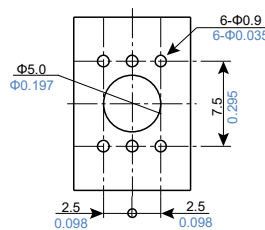

Terminal connection diagram

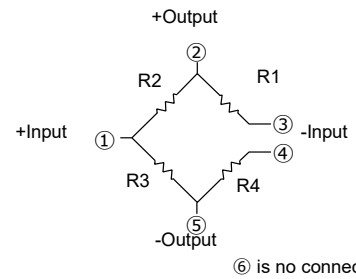

Terminal No.	Name
1	Power supply (+)
2	Output (+)
3	Power supply (-)
4	Power supply (-)
5	Output (-)
6	NC (No connection)

Note: Leave terminal 6 unconnected.

● Terminal direction : SMD terminal ADP4932, ADP4933

CAD data

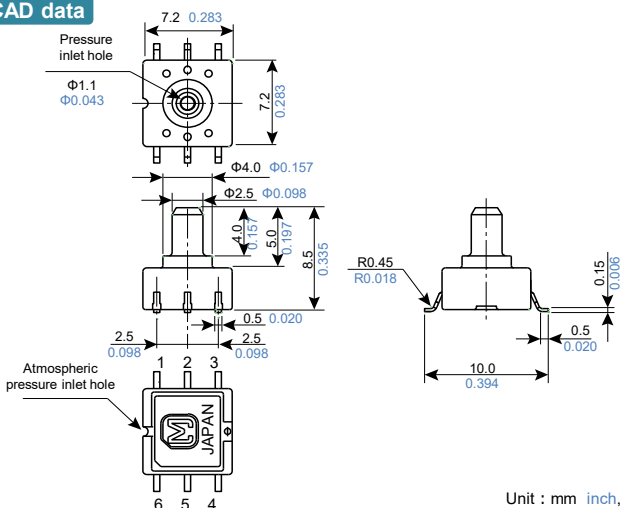

Recommended PC board pattern (BOTTOM VIEW)

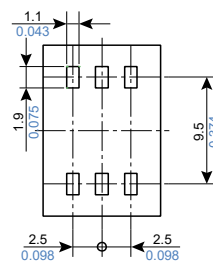

Terminal connection diagram

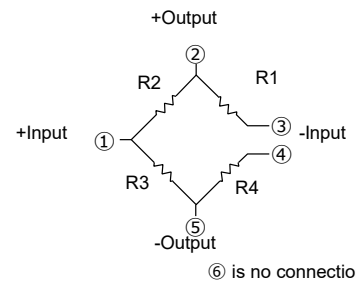

Terminal No.	Name
1	Power supply (+)
2	Output (+)
3	Power supply (-)
4	Power supply (-)
5	Output (-)
6	NC (No connection)

Note: Leave terminal 6 unconnected.

Dimensions

The CAD data of the products with a **CAD data** mark can be downloaded from: <http://industrial.panasonic.com/>

[PF pressure sensor]

● Terminal direction : DIP terminal Direction opposite to the pressure inlet direction ADP11□□

CAD data

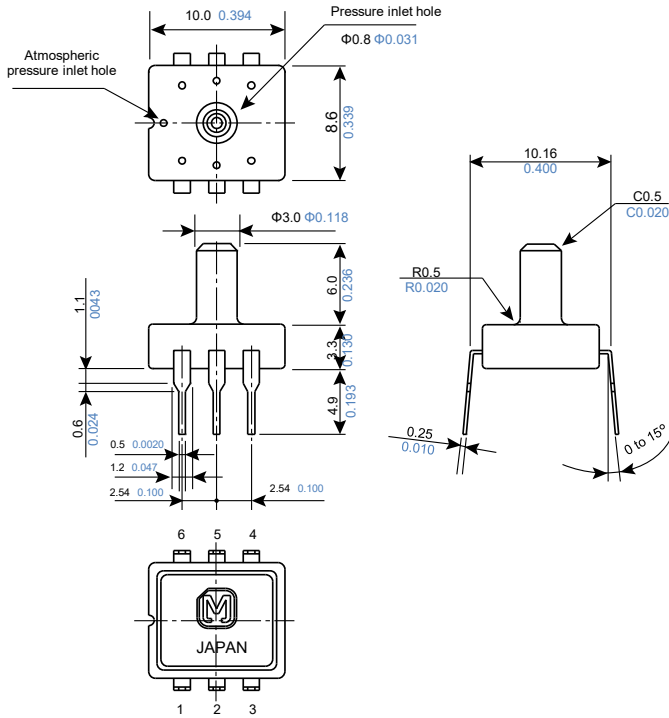

Recommended PC board pattern (BOTTOM VIEW)

Terminal connection diagram

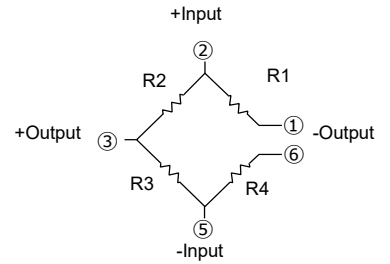

Terminal No.	Name
1	-Output (-)
2	Power supply (+)
3	+Output (+)
4	No connection
5	Power supply (-)
6	-Output (-)

Note: Leave terminal 4 unconnected.

unit : mm inch, General tolerance : ±0.3 ±0.012

● Terminal direction : DIP terminal Pressure inlet direction ADP12□□

CAD data

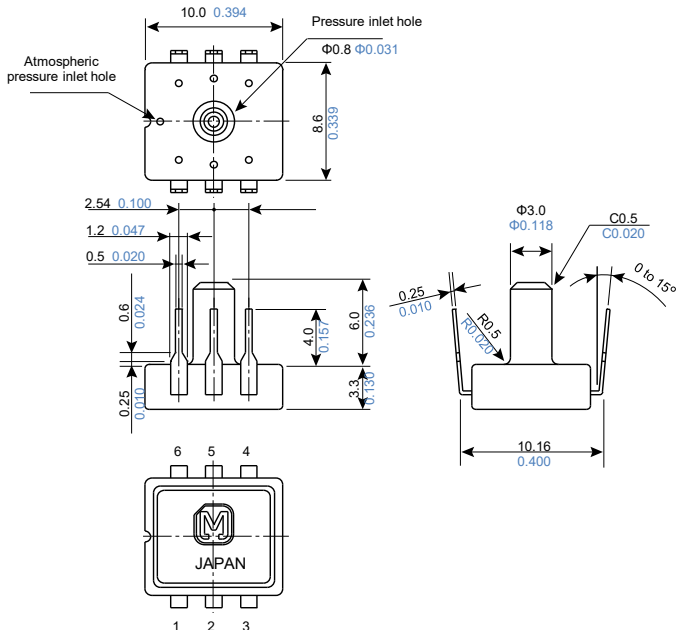

Recommended PC board pattern (BOTTOM VIEW)

Terminal connection diagram

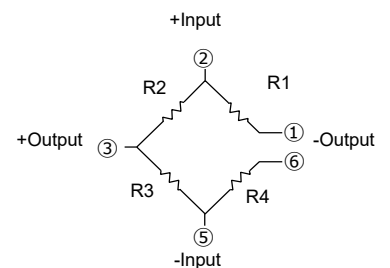

Terminal No.	Name
1	-Output (-)
2	Power supply (+)
3	+Output (+)
4	No connection
5	Power supply (-)
6	-Output (-)

Note: Leave terminal 4 unconnected.

unit : mm inch, General tolerance : ±0.3 ±0.012

Explanation of terms

■ Pressure object

This is what can be used to activate the pressure sensor.
(The Panasonic Corporation pressure sensor can be used with gas.)

■ Rated pressure

The pressure value up to which the specifications of the pressure sensor are guaranteed.

■ Maximum applied pressure

The maximum pressure that can be applied to the pressure sensor, after which, when the pressure is returned to below the rated pressure range, the specifications of the pressure sensor are guaranteed.

■ Temperature compensation range

The temperature range across which the specification values of the pressure sensor are guaranteed.

■ Drive current (voltage)

The supply current (voltage) required to drive a pressure sensor.

■ Output span voltage

The difference between the rated output voltage and the offset voltage. The output span voltage is also called the full-scale voltage (FS).

■ Offset voltage

The output voltage of a pressure sensor when no pressure is applied.

■ Rated pressure output voltage

Output voltage when rated pressure is applied.

■ Linearity

When the pressure is varied from no load to the rated pressure, the linearity is the amount of shift between the straight line that joins the no-load voltage value and the rated pressure voltage value (expressed as the ratio of the amount of shift (D1) at half of the rated pressure value with respect to the full scale voltage (FS)).

■ Output hysteresis

The ratio of the difference (D2) in the no-load output voltages when the pressure is varied from no load to the rated pressure then reduced back to no load, with respect to the full scale voltage (FS).

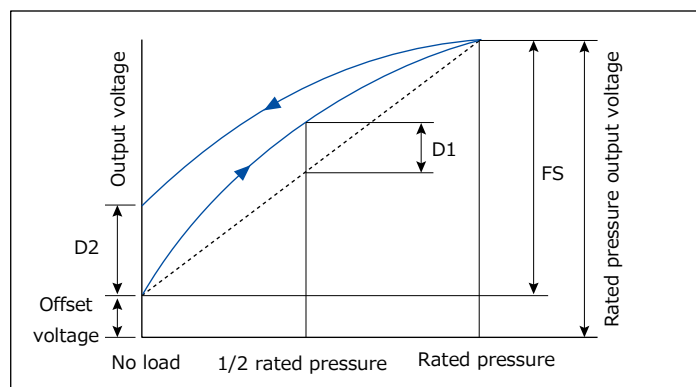

■ Offset voltage temperature characteristic

The variation of the offset voltage with changes in ambient temperature. The difference between the offset voltage at the standard temperature and the offset values at the compensation lower limit temperature (low temperature) (D1) and compensation upper limit temperature (high temperature) (D2) are obtained, and the offset voltage temperature characteristic is expressed as the ratio of the larger of these two differences (absolute) with respect to the full scale voltage (FS).

Explanation of terms

■ **Temperature sensitivity characteristic**

The variation of the sensitivity with changes in ambient temperature (variation in full scale (FS)). The difference between the full scale voltage at the standard temperature (FS) and the full scale values at the compensation lower limit temperature (low temperature) (FS1) and compensation upper limit temperature (high temperature) (FS2) are obtained, and the offset voltage temperature characteristic is expressed as the ratio of the larger of these two differences (FS1 - FS and FS2 - FS (absolute)) with respect to the full scale voltage (FS).

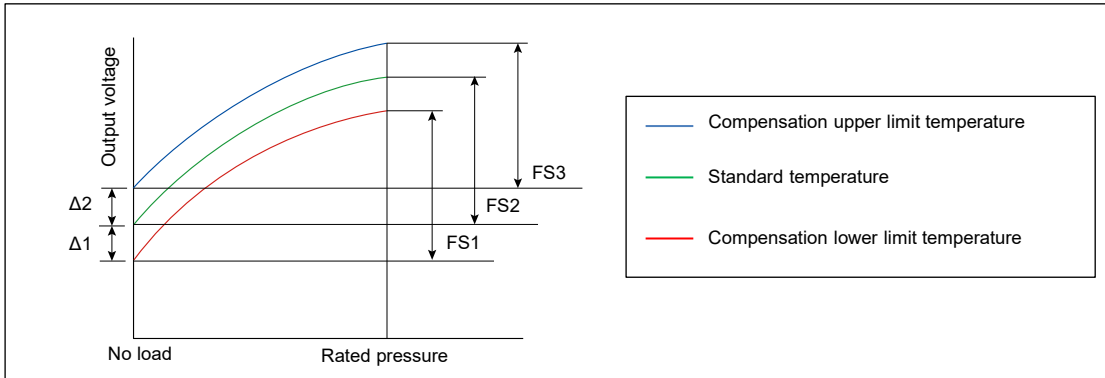

■ **Bridge resistance**

Refers to the resistance value of a piezo resistance formed on a monolithic silicon substrate. For example, the values of the resistances R1 to R4 in the bridge are typically 5 kΩ each.

* When the resistances of the resistive elements R1 to R4 that comprise the bridge are 5 kΩ each, the equivalent composite resistance of the bridge is 5kΩ (3 kΩ bridges are also available).

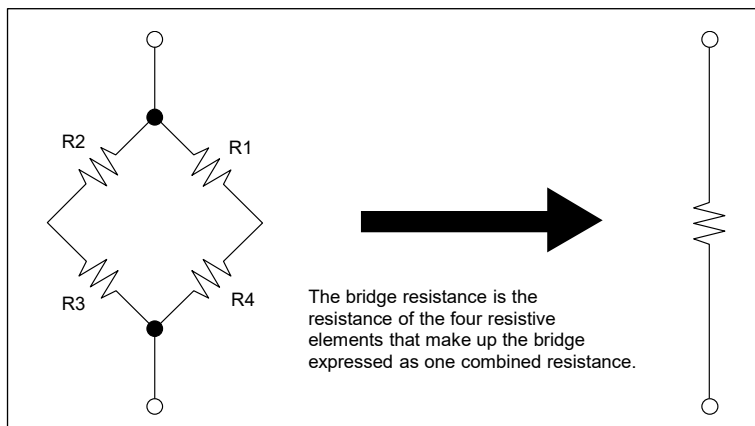

■ **Overall accuracy**

Accuracy of offset voltage and rated pressure output voltage within the temperature compensation range.

Safety Precautions

When using our products, no matter what sort of equipment they might be used for, be sure to confirm the applications and environmental conditions with our specifications in advance.

Panasonic
INDUSTRY

Panasonic Industry Co., Ltd.
Device Solutions Business Division

1006 Kadoma, Kadoma City, Osaka
571-8506 Japan