

TABLE OF CONTENTS

Features	1	Overview	25
Interface	1	Analog Input Channel	26
Applications	1	PGA	26
General Description	1	Reference	26
Functional Block Diagram	1	Reference Detect	26
Revision History	2	Bipolar/Unipolar Configuration	27
Specifications	3	Data Output Coding	27
Timing Characteristics	6	Burnout Currents	27
Absolute Maximum Ratings	8	AC Excitation	27
Thermal Resistance	8	Channel Sequencer	28
ESD Caution	8	Digital Interface	28
Pin Configuration and Function Descriptions	9	Reset	32
Typical Performance Characteristics	11	System Synchronization	32
RMS Noise and Resolution	13	Clock	32
Sinc ⁴ Chop Disabled	13	Enable Parity	32
Sinc ³ Chop Disabled	14	Temperature Sensor	32
Sinc ⁴ Chop Enabled	15	Bridge Power-Down Switch	33
Sinc ³ Chop Enabled	16	Calibration	33
On-Chip Registers	17	Digital Filter	34
Communications Register	18	Sinc ⁴ Filter (Chop Disabled)	34
Status Register	19	Sinc ³ Filter (Chop Disabled)	36
Mode Register	19	Chop Enabled (Sinc ⁴ Filter)	38
Configuration Register	21	Chop Enabled (Sinc ³ Filter)	40
Data Register	23	Summary of Filter Options	41
ID Register	23	Grounding and Layout	42
GPOCON Register	23	Applications Information	43
Offset Register	24	Weigh Scales	43
Full-Scale Register	24	Outline Dimensions	44
ADC Circuit Information	25	Ordering Guide	44

REVISION HISTORY

7/2017—Rev. A to Rev. B

Changed CP-32-11 to CP-32-12	Throughout
Changes to Table 5	10
Updated Outline Dimensions	44
Changes to Ordering Guide	44

1/2010—Revision 0: Initial Version

SPECIFICATIONS

$AV_{DD} = 4.75\text{ V to }5.25\text{ V}$, $DV_{DD} = 2.7\text{ V to }5.25\text{ V}$, $AGND = DGND = 0\text{ V}$; $REFIN(+)$ = AV_{DD} , $REFIN(-)$ = $AGND$, $MCLK = 4.92\text{ MHz}$, $T_A = T_{MIN}$ to T_{MAX} , unless otherwise noted.

Table 1.

Parameter	Min	Typ	Max	Unit	Test Conditions/Comments ¹	
ADC						
Output Data Rate	4.7		4800	Hz	Chop disabled	
	1.17		1200	Hz	Chop enabled, sinc ⁴ filter	
	1.56		1600	Hz	Chop enabled, sinc ³ filter	
No Missing Codes ²	24			Bits	FS > 1, sinc ⁴ filter ³	
	24			Bits	FS > 4, sinc ³ filter ³	
Resolution					See the RMS Noise and Resolution section	
RMS Noise and Output Data Rates					See the RMS Noise and Resolution section	
Integral Nonlinearity						
Gain = 1 ²		±1	±5	ppm of FSR		
Gain > 1		±5	±15	ppm of FSR		
Offset Error ^{4, 5}		±75/gain		μV	Chop disabled	
		±0.5		μV	Chop enabled	
Offset Error Drift vs. Temperature		±100/gain		nV/°C	Gain = 1 to 16; chop disabled	
		±5		nV/°C	Gain = 32 to 128; chop disabled	
Offset Error Drift vs. Time		±5		nV/°C	Chop enabled	
		25		nV/1000 hours	Gain ≥ 32	
Gain Error ⁴		±0.001	±0.005	% max	$AV_{DD} = 5\text{ V}$, gain = 1, $T_A = 25^\circ\text{C}$ (factory calibration conditions)	
		±0.006		%	Gain > 1, post internal full-scale calibration	
Gain Drift vs. Temperature		±1		ppm/°C		
Gain Drift vs. Time		10		ppm/1000 hours	Gain = 1	
Power Supply Rejection		95		dB	Gain = 1, $V_{IN} = 1\text{ V}$	
	98	103			Gain = 8, $V_{IN} = 1\text{ V/gain}$	
	100	110		dB	Gain > 8, $V_{IN} = 1\text{ V/gain}$	
Common-Mode Rejection						
	@ DC ²	100	115	dB min	Gain = 1, $V_{IN} = 1\text{ V}$	
	@ DC	115	140	dB min	Gain > 1, $V_{IN} = 1\text{ V/gain}$	
	@ 50 Hz, 60 Hz ²	120		dB	10 Hz output data rate, 50 ± 1 Hz, 60 ± 1 Hz	
@ 50 Hz, 60 Hz ²	120		dB	50 ± 1 Hz (50 Hz output data rate), 60 ± 1 Hz (60 Hz output data rate)		
Normal Mode Rejection ²						
	Sinc ⁴ Filter					
	Internal Clock					
	@ 50 Hz, 60 Hz	100			dB	10 Hz output data rate, 50 ± 1 Hz, 60 ± 1 Hz
		74			dB	50 Hz output data rate, REJ60 ⁶ = 1, 50 ± 1 Hz, 60 ± 1 Hz
	@ 50 Hz	96			dB	50 Hz output data rate, 50 ± 1 Hz
	@ 60 Hz	97			dB	60 Hz output data rate, 60 ± 1 Hz
	External Clock					
	@ 50 Hz, 60 Hz	120			dB	10 Hz output data rate, 50 ± 1 Hz, 60 ± 1 Hz
		82			dB	50 Hz output data rate, REJ60 ⁶ = 1, 50 ± 1 Hz, 60 ± 1 Hz
	@ 50 Hz	120			dB	50 Hz output data rate, 50 ± 1 Hz
	@ 60 Hz	120			dB	60 Hz output data rate, 60 ± 1 Hz
Sinc ³ Filter						
Internal Clock						
@ 50 Hz, 60 Hz	75			dB	10 Hz output data rate, 50 ± 1 Hz, 60 ± 1 Hz	
	60			dB	50 Hz output data rate, REJ60 ⁶ = 1, 50 ± 1 Hz, 60 ± 1 Hz	
@ 50 Hz	70			dB	50 Hz output data rate, 50 ± 1 Hz	
@ 60 Hz	70			dB	60 Hz output data rate, 60 ± 1 Hz	

Parameter	Min	Typ	Max	Unit	Test Conditions/Comments ¹
External Clock @ 50 Hz, 60 Hz	100			dB	10 Hz output data rate, 50 ± 1 Hz, 60 ± 1 Hz
	67			dB	50 Hz output data rate, REJ60 ⁶ = 1, 50 ± 1 Hz, 60 ± 1 Hz
@ 50 Hz	95			dB	50 Hz output data rate, 50 ± 1 Hz
@ 60 Hz	95			dB	60 Hz output data rate, 60 ± 1 Hz
ANALOG INPUTS					
Differential Input Voltage Ranges		±V _{REF} /gain		V	V _{REF} = REFIN(+) – REFIN(–), gain = 1 to 128
	–(AV _{DD} – 1.25 V)/gain		+(AV _{DD} – 1.25 V)/gain	V	Gain > 1
Absolute AIN Voltage Limits ²					
Unbuffered Mode	AGND – 0.05		AV _{DD} + 0.05	V	
Buffered Mode	AGND + 0.25		AV _{DD} – 0.25	V	
Analog Input Current					
Buffered Mode					
Input Current ²	–2		+2	nA	Gain = 1
	–4.5		+4.5	nA	Gain > 1
Input Current Drift		±5		pA/°C	
Unbuffered Mode					
Input Current		±5		μA/V	Gain = 1, input current varies with input voltage
		±1		μA/V	Gain > 1
Input Current Drift		±0.05		nA/V/°C	External clock
		±1.6		nA/V/°C	Internal clock
REFERENCE INPUT					
REFIN Voltage	1	AV _{DD}	AV _{DD}	V	REFIN = REFIN(+) – REFIN(–). The differential input must be limited to ±(AV _{DD} – 1.25 V)/gain when gain > 1
Absolute REFIN Voltage Limits ²	GND – 0.05		AV _{DD} + 0.05	V	
Average Reference Input Current		7		μA/V	
Average Reference Input Current Drift		±0.03		nA/V/°C	External clock
		±1.3		nA/V/°C	Internal clock
Normal Mode Rejection ²		Same as for analog inputs			
Common-Mode Rejection Reference Detect Levels	0.3	95	0.6	dB	
TEMPERATURE SENSOR					
Accuracy		±2		°C	Applies after user calibration at 25°C
Sensitivity		2815		Codes/°C	Bipolar mode
BRIDGE POWER-DOWN SWITCH					
R _{ON}			10	Ω	
Allowable Current ²			30	mA	Continuous current
BURNOUT CURRENTS					
AIN Current		500		nA	Analog inputs must be buffered and chop disabled
DIGITAL OUTPUTS (ACXx, ACXX)					
Output High Voltage, V _{OH} ²	4			V	AV _{DD} = 5 V, I _{SOURCE} = 200 μA
Output Low Voltage, V _{OL} ²			0.4	V	AV _{DD} = 5 V, I _{SINK} = 800 μA
INTERNAL/EXTERNAL CLOCK					
Internal Clock					
Frequency	4.72		5.12	MHz	
Duty Cycle		50:50		%	
External Clock/Crystal ²					
Frequency	2.4576	4.9152	5.12	MHz	
Input Low Voltage V _{INL}			0.8	V	DV _{DD} = 5 V
			0.4	V	DV _{DD} = 3 V
Input High Voltage, V _{INH}	2.5			V	DV _{DD} = 3 V
	3.5			V	DV _{DD} = 5 V
Input Current	–10		+10	μA	

Parameter	Min	Typ	Max	Unit	Test Conditions/Comments ¹
LOGIC INPUTS					
Input High Voltage, V_{INH}^2	2			V	
Input Low Voltage, V_{INL}^2			0.8	V	
Hysteresis ²	0.1		0.25	V	
Input Currents	-10		+10	μ A	
LOGIC OUTPUT (DOUT/RDY)					
Output High Voltage, V_{OH}^2	$DV_{DD} - 0.6$			V	$DV_{DD} = 3\text{ V}$, $I_{SOURCE} = 100\ \mu\text{A}$
Output Low Voltage, V_{OL}^2			0.4	V	$DV_{DD} = 3\text{ V}$, $I_{SINK} = 100\ \mu\text{A}$
Output High Voltage, V_{OH}^2	4			V	$DV_{DD} = 5\text{ V}$, $I_{SOURCE} = 200\ \mu\text{A}$
Output Low Voltage, V_{OL}^2			0.4	V	$DV_{DD} = 5\text{ V}$, $I_{SINK} = 1.6\text{ mA}$
Floating-State Leakage Current	-10		+10	μ A	
Floating-State Output Capacitance		10		pF	
Data Output Coding		Offset binary			
SYSTEM CALIBRATION ²					
Full-Scale Calibration Limit			$1.05 \times FS$	V	
Zero-Scale Calibration Limit	$-1.05 \times FS$			V	
Input Span	$0.8 \times FS$		$2.1 \times FS$	V	
POWER REQUIREMENTS ⁷					
Power Supply Voltage					
$AV_{DD} - AGND$	4.75		5.25	V	
$DV_{DD} - DGND$	2.7		5.25	V	
Power Supply Currents					
I_{DD} Current		0.85	1	mA	gain = 1, buffer off
		1.1	1.3	mA	gain = 1, buffer on
		3.5	4.5	mA	gain = 8, buffer off
		4	5	mA	gain = 8, buffer on
		5	6.4	mA	gain = 16 to 128, buffer off
		5.5	6.9	mA	gain = 16 to 128, buffer on
$D I_{DD}$ Current		0.35	0.4	mA	$DV_{DD} = 3\text{ V}$
		0.5	0.6	mA	$DV_{DD} = 5\text{ V}$
		1.5		mA	External crystal used
I_{DD} (Power-Down Mode)			2	μ A	

¹ Temperature range: -40°C to $+105^{\circ}\text{C}$.

² Specification is not production tested, but is supported by characterization data at initial product release.

³ FS is the decimal equivalent of Bit FS9 to Bit FS0 in the mode register.

⁴ Following a system or internal zero-scale calibration, the offset error is in the order of the noise for the programmed gain and output data rate selected. A system full-scale calibration reduces the gain error to the order of the noise for the programmed gain and output data rate.

⁵ The analog inputs are configured for differential mode.

⁶ REJ60 is a bit in the mode register. When the output data rate is set to 50 Hz, setting REJ60 to 1 places a notch at 60 Hz, allowing simultaneous 50 Hz/60 Hz rejection.

⁷ Digital inputs equal to DV_{DD} or $DGND$.

TIMING CHARACTERISTICS

$AV_{DD} = 4.75\text{ V to }5.25\text{ V}$, $DV_{DD} = 2.7\text{ V to }5.25\text{ V}$, $AGND = DGND = 0\text{ V}$, Input Logic 0 = 0 V, Input Logic 1 = DV_{DD} , unless otherwise noted.

Table 2.

Parameter	Limit at T_{MIN} , T_{MAX} (B Version)	Unit	Conditions/Comments ^{1, 2}
READ AND WRITE OPERATIONS			
t_3	100	ns min	SCLK high pulse width
t_4	100	ns min	SCLK low pulse width
READ OPERATION			
t_1	0	ns min	\overline{CS} falling edge to $\overline{DOUT}/\overline{RDY}$ active time
	60	ns max	$DV_{DD} = 4.75\text{ V to }5.25\text{ V}$
	80	ns max	$DV_{DD} = 2.7\text{ V to }3.6\text{ V}$
t_2^3	0	ns min	SCLK active edge to data valid delay ⁴
	60	ns max	$DV_{DD} = 4.75\text{ V to }5.25\text{ V}$
	80	ns max	$DV_{DD} = 2.7\text{ V to }3.6\text{ V}$
$t_5^{5, 6}$	10	ns min	Bus relinquish time after \overline{CS} inactive edge
	80	ns max	
t_6	0	ns min	SCLK inactive edge to \overline{CS} inactive edge
t_7	10	ns min	SCLK inactive edge to $\overline{DOUT}/\overline{RDY}$ high
WRITE OPERATION			
t_8	0	ns min	\overline{CS} falling edge to SCLK active edge setup time ⁴
t_9	30	ns min	Data valid to SCLK edge setup time
t_{10}	25	ns min	Data valid to SCLK edge hold time
t_{11}	0	ns min	\overline{CS} rising edge to SCLK edge hold time

¹ Sample tested during initial release to ensure compliance. All input signals are specified with $t_R = t_F = 5\text{ ns}$ (10% to 90% of DV_{DD}) and timed from a voltage level of 1.6 V.

² See Figure 3 and Figure 4.

³ These numbers are measured with the load circuit shown in Figure 2 and defined as the time required for the output to cross the V_{OL} or V_{OH} limits.

⁴ The SCLK active edge is the falling edge of SCLK.

⁵ These numbers are derived from the measured time taken by the data output to change 0.5 V when loaded with the circuit shown in Figure 2. The measured number is then extrapolated back to remove the effects of charging or discharging the 50 pF capacitor. This means that the times quoted in the timing characteristics are the true bus relinquish times of the part and, as such, are independent of external bus loading capacitances.

⁶ \overline{RDY} returns high after a read of the data register. In single conversion mode and continuous conversion mode, the same data can be read again, if required, while \overline{RDY} is high, although care should be taken to ensure that subsequent reads do not occur close to the next output update. If the continuous read feature is enabled, the digital word can be read only once.

Circuit and Timing Diagram

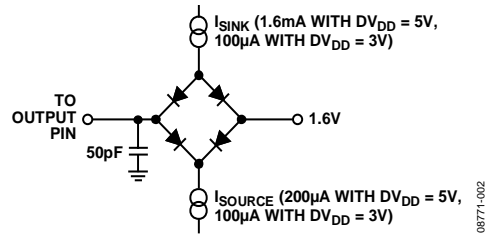

Figure 2. Load Circuit for Timing Characterization

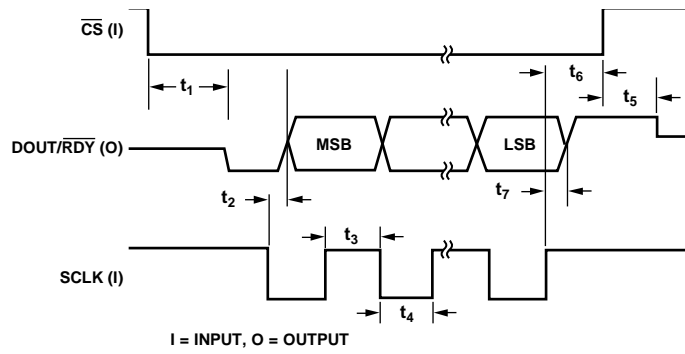

Figure 3. Read Cycle Timing Diagram

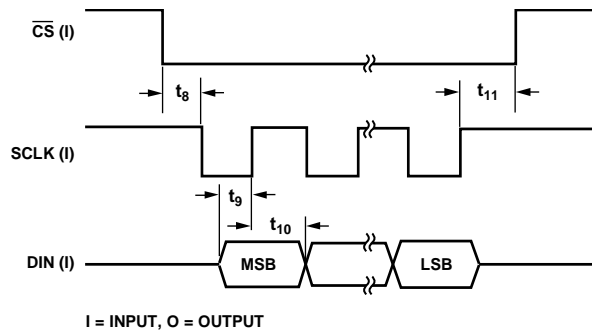

Figure 4. Write Cycle Timing Diagram

ABSOLUTE MAXIMUM RATINGS

$T_A = 25^\circ\text{C}$, unless otherwise noted.

Table 3.

Parameter	Rating
AV_{DD} to AGND	-0.3 V to +6.5 V
DV_{DD} to AGND	-0.3 V to +6.5 V
AGND to DGND	-0.3 V to +0.3 V
Analog Input Voltage to AGND	-0.3 V to $AV_{DD} + 0.3$ V
Reference Input Voltage to AGND	-0.3 V to $AV_{DD} + 0.3$ V
Digital Input Voltage to DGND	-0.3 V to $DV_{DD} + 0.3$ V
Digital Output Voltage to DGND	-0.3 V to $DV_{DD} + 0.3$ V
AIN/Digital Input Current	10 mA
Operating Temperature Range	-40°C to $+105^\circ\text{C}$
Storage Temperature Range	-65°C to $+150^\circ\text{C}$
Maximum Junction Temperature	150°C
Lead Temperature, Soldering Reflow	260°C

Stresses at or above those listed under Absolute Maximum Ratings may cause permanent damage to the product. This is a stress rating only; functional operation of the product at these or any other conditions above those indicated in the operational section of this specification is not implied. Operation beyond the maximum operating conditions for extended periods may affect product reliability.

THERMAL RESISTANCE

θ_{JA} is specified for the worst-case conditions, that is, a device soldered in a circuit board for surface-mount packages.

Table 4. Thermal Resistance

Package Type	θ_{JA}	θ_{JC}	Unit
32-Lead LFCSP	32.5	32.71	$^\circ\text{C}/\text{W}$

ESD CAUTION



ESD (electrostatic discharge) sensitive device. Charged devices and circuit boards can discharge without detection. Although this product features patented or proprietary protection circuitry, damage may occur on devices subjected to high energy ESD. Therefore, proper ESD precautions should be taken to avoid performance degradation or loss of functionality.

PIN CONFIGURATION AND FUNCTION DESCRIPTIONS

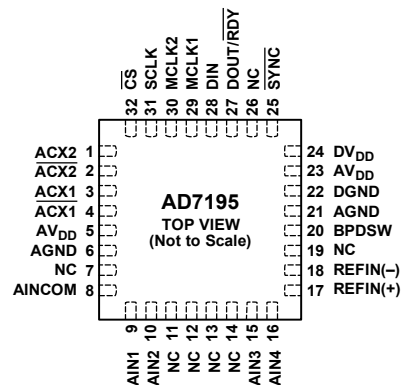

- NOTES
 1. NC = NO CONNECT.
 2. CONNECT EXPOSED PAD TO AGND.

08771-005

Figure 5. Pin Configuration

Table 5. Pin Function Descriptions

Pin No.	Mnemonic	Description
1	ACX2	Digital Output. Provides a signal that can be used to control the reversing of the bridge excitation in ac excited bridge applications. In ac mode, ACX2 toggles in anti-phase with ACX1. If the ACX bit equals zero (ac excitation turned off), the ACX2 output remains low. When toggling, it is guaranteed to be nonoverlapping with ACX1. The nonoverlap interval between ACX1 and ACX2 is 1/(master clock) which is equal to 200 ns when a 4.92 MHz clock is used.
2	ACX2	Digital Output. Provides a signal that can be used to control the reversing of the bridge excitation in ac excited bridge applications. This output is the inverse of ACX2. If the ACX bit equals zero (ac excitation turned off), the ACX2 output remains high.
3	ACX1	Digital Output. Provides a signal that can be used to control the reversing of the bridge excitation in ac excited bridge applications. When ACX1 is high, the bridge excitation is taken as normal and when ACX1 is low, the bridge excitation is reversed (chopped). If the Bit ACX equals zero (ac excitation turned off), the ACX1 output remains high.
4	ACX1	Digital Output. Provides a signal that can be used to control the reversing of the bridge excitation in ac excited bridge applications. This output is the inverse of ACX1. When ACX1 is low, the bridge excitation is taken as normal and when ACX1 is high, the bridge excitation is reversed (chopped). If the ACX bit equals zero (ac excitation turned off), the ACX1 output remains low.
5	AV _{DD}	Analog Supply Voltage, 4.75 V to 5.25 V. AV _{DD} is independent of DV _{DD} .
6	AGND	Analog Ground Reference Point.
7	NC	No Connect. This pin should be tied to AGND.
8	AINCOM	Analog inputs AIN1 to AIN4 are referenced to this input when configured for pseudo differential operation.
9	AIN1	Analog Input. This pin can be configured as the positive input of a fully differential input pair when used with AIN2 or as a pseudo differential input when used with AINCOM.
10	AIN2	Analog Input. This pin can be configured as the negative input of a fully differential input pair when used with AIN1 or as a pseudo differential input when used with AINCOM.
11	NC	No Connect. This pin should be tied to AGND.
12	NC	No Connect. This pin should be tied to AGND.
13	NC	No Connect. This pin should be tied to AGND.
14	NC	No Connect. This pin should be tied to AGND.
15	AIN3	Analog Input. This pin can be configured as the positive input of a fully differential input pair when used with AIN4 or as a pseudo differential input when used with AINCOM.
16	AIN4	Analog Input. This pin can be configured as the negative input of a fully differential input pair when used with AIN3 or as a pseudo differential input when used with AINCOM.
17	REFIN(+)	Positive Reference Input. An external reference can be applied between REFIN(+) and REFIN(-). REFIN(+) can lie anywhere between AV _{DD} and AGND + 1 V. The nominal reference voltage, (REFIN(+) – REFIN(-)), is AV _{DD} , but the part functions with a reference from 1 V to AV _{DD} .
18	REFIN(-)	Negative Reference Input. This reference input can lie anywhere between AGND and AV _{DD} – 1 V.
19	NC	No Connect. This pin should be tied to AGND.

Pin No.	Mnemonic	Description
20	BPDSW	Bridge Power-Down Switch to AGND.
21	AGND	Analog Ground Reference Point.
22	DGND	Digital Ground Reference Point.
23	AV _{DD}	Analog Supply Voltage, 4.75 V to 5.25 V. AV _{DD} is independent of DV _{DD} .
24	DV _{DD}	Digital Supply Voltage, 2.7 V to 5.25 V. DV _{DD} is independent of AV _{DD} .
25	SYNC	Logic input that allows for <u>s</u> ynchronization of the digital filters and analog modulators when using a number of AD7195 devices. While <u>S</u> YNC is low, the nodes of the digital filter, the filter control logic, and the calibration control logic are reset, and the analog modulator is also held in its reset state. <u>S</u> YNC does not affect the digital interface but does reset <u>R</u> DY to a high state if it is low. <u>S</u> YNC has a pull-up resistor internally to DV _{DD} .
26	NC	No Connect. This pin should be tied to AGND.
27	DOUT/ <u>R</u> DY	Serial Data Output/Data Ready Output. DOUT/ <u>R</u> DY serves a dual purpose. It functions as a serial data output pin to access the output shift register of the ADC. The output shift register can contain data from any of the on-chip data or control registers. In addition, DOUT/ <u>R</u> DY operates as a data ready pin, going low to indicate the completion of a conversion. If the data is not read after the conversion, the pin goes high before the next update occurs. The DOUT/ <u>R</u> DY falling edge can be used as an interrupt to a processor, indicating that valid data is available. With an external serial clock, the data can be read using the DOUT/ <u>R</u> DY pin. With <u>C</u> S low, the data-/control-word information is placed on the DOUT/ <u>R</u> DY pin on the SCLK falling edge and is valid on the SCLK rising edge.
28	DIN	Serial Data Input to the Input Shift Register on the ADC. Data in this shift register is transferred to the control registers in the ADC, with the register selection bits of the communications register identifying the appropriate register.
29	MCLK1	When the master clock for the device is provided externally by a crystal, the crystal is connected between MCLK1 and MCLK2.
30	MCLK2	Master Clock Signal for the Device. The AD7195 has an internal 4.92 MHz clock. This internal clock can be made available on the MCLK2 pin. The clock for the AD7195 can be provided externally also in the form of a crystal or external clock. A crystal can be tied across the MCLK1 and MCLK2 pins. Alternatively, the MCLK2 pin can be driven with a CMOS-compatible clock and the MCLK1 pin left unconnected.
31	SCLK	Serial Clock Input. This serial clock input is for data transfers to and from the ADC. The SCLK has a Schmitt-triggered input, making the interface suitable for opto-isolated applications. The serial clock can be continuous with all data transmitted in a continuous train of pulses. Alternatively, it can be a noncontinuous clock with the information transmitted to or from the ADC in smaller batches of data.
32	<u>C</u> S	Chip Select Input. This is an active low logic input used to select the ADC. <u>C</u> S can be used to select the ADC in systems with <u>m</u> ore than one device on the serial bus or as a frame synchronization signal in communicating with the device. <u>C</u> S can be hardwired low, allowing the ADC to operate in 3-wire mode with SCLK, DIN, and DOUT used to interface with the device.
	EPAD	Exposed Pad. Connect the exposed pad to AGND.

TYPICAL PERFORMANCE CHARACTERISTICS

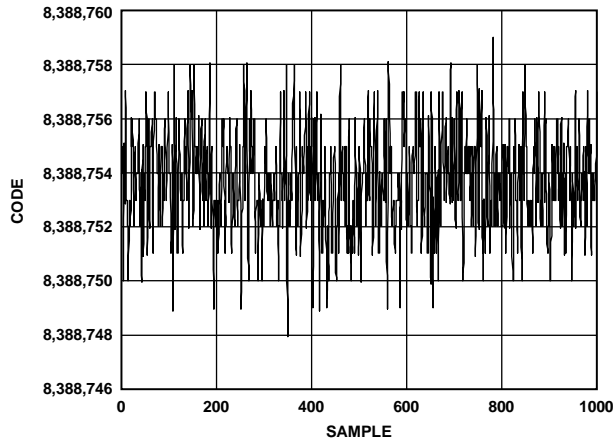

Figure 6. Noise ($V_{REF} = 5\text{ V}$, Output Data Rate = 4.7 Hz, Gain = 128, Chop Disabled, Sinc⁴ Filter)

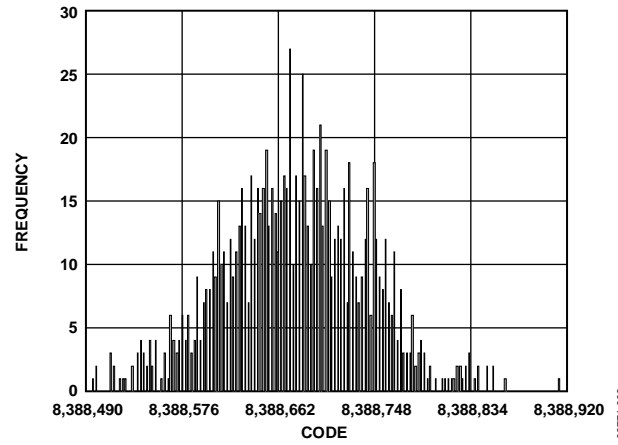

Figure 9. Noise Distribution Histogram ($V_{REF} = 5\text{ V}$, Output Data Rate = 4800 Hz, Gain = 128, Chop Disabled, Sinc⁴ Filter)

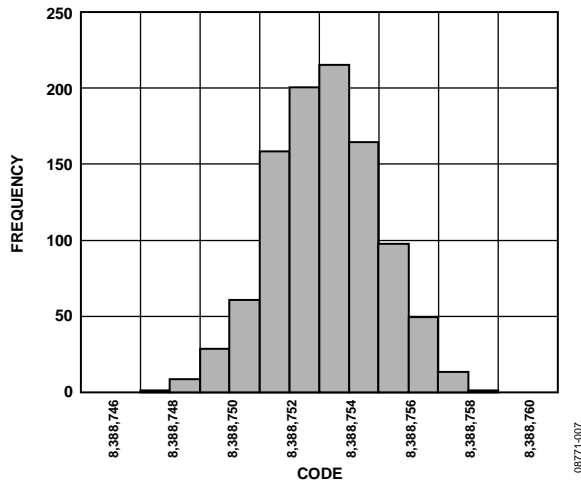

Figure 7. Noise Distribution Histogram ($V_{REF} = 5\text{ V}$, Output Data Rate = 4.7 Hz, Gain = 128, Chop Disabled, Sinc⁴ Filter)

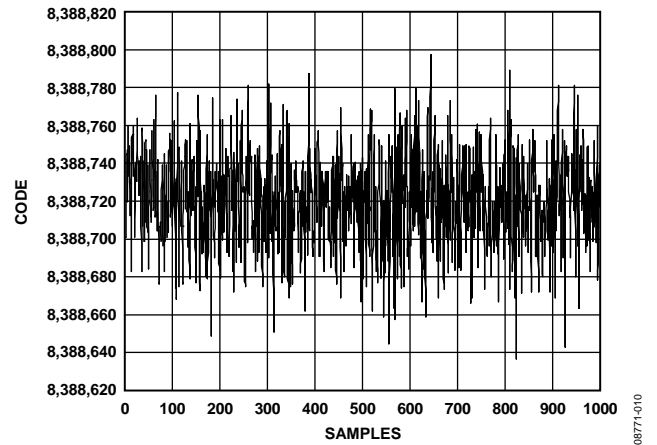

Figure 10. Noise ($V_{REF} = 5\text{ V}$, Output Data Rate = 4800 Hz, Gain = 1, Chop Disabled, Sinc⁴ Filter)

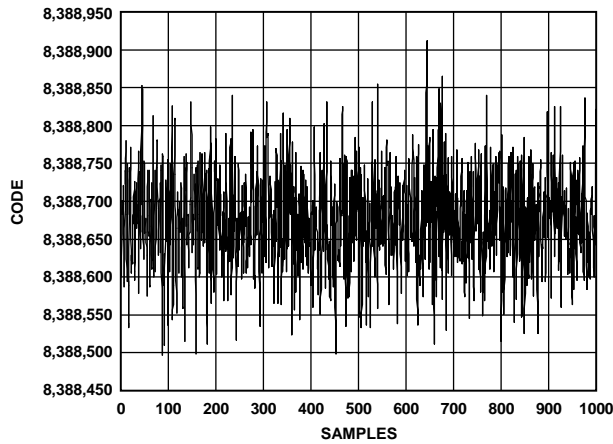

Figure 8. Noise ($V_{REF} = 5\text{ V}$, Output Data Rate = 4800 Hz, Gain = 128, Chop Disabled, Sinc⁴ Filter)

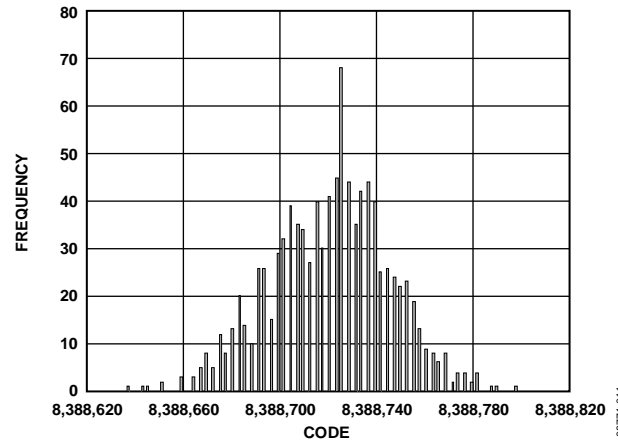

Figure 11. Noise Distribution Histogram ($V_{REF} = 5\text{ V}$, Output Data Rate = 4800 Hz, Gain = 1, Chop Disabled, Sinc⁴ Filter)

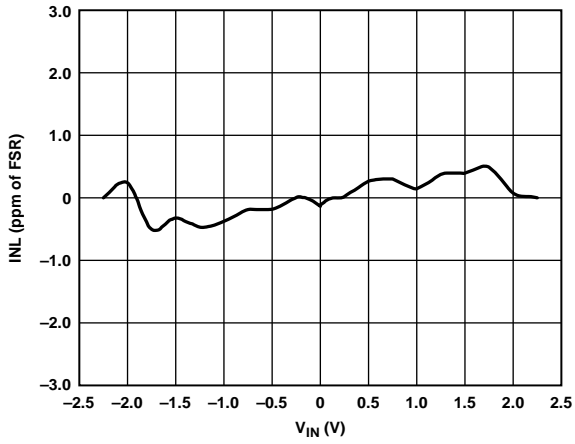

Figure 12. INL (Gain = 1)

08771-012

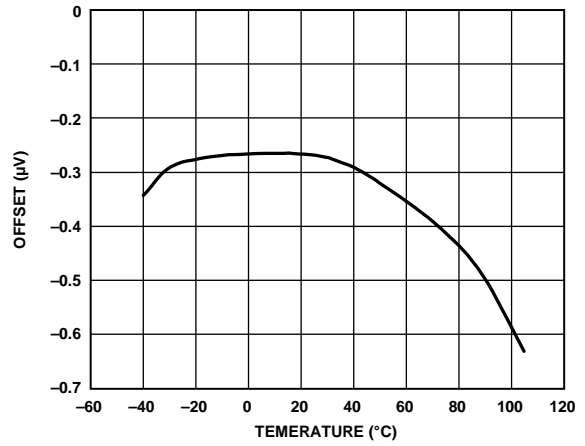

Figure 15. Offset Error (Gain = 128, Chop Disabled)

08771-015

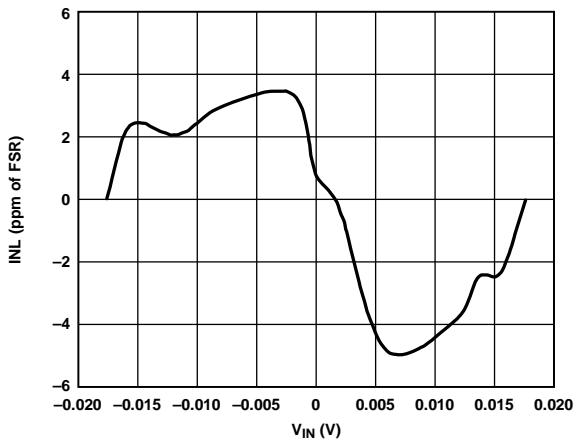

Figure 13. INL (Gain = 128)

08771-013

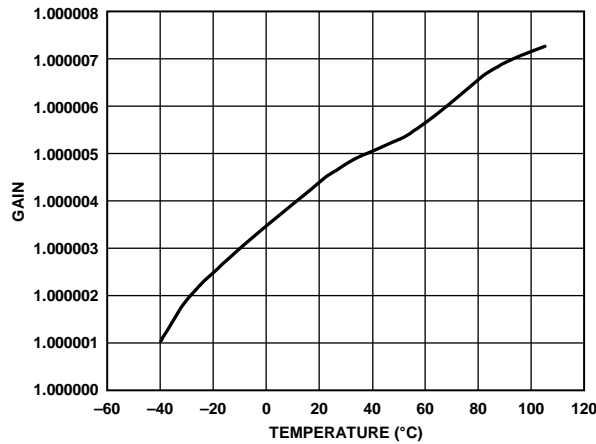

Figure 16. Gain Error (Gain = 1, Chop Disabled)

08771-016

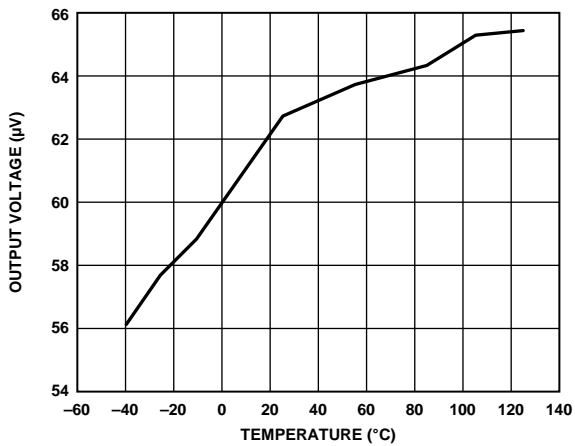

Figure 14. Offset Error (Gain = 1, Chop Disabled)

08771-014

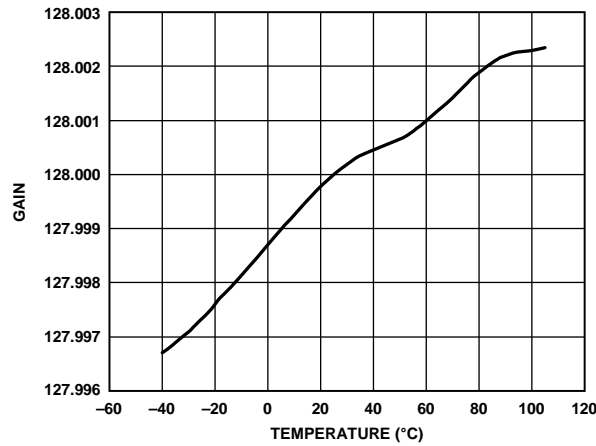

Figure 17. Gain Error (Gain = 128, Chop Disabled)

08771-017

RMS NOISE AND RESOLUTION

The tables in this section show the rms noise, peak-to-peak noise, effective resolution, and noise-free (peak-to-peak) resolution of the AD7195 for various output data rates and gain settings, with chop disabled and chop enabled for the sinc⁴ and sinc³ filters. The numbers given are for the bipolar input range with the external 5 V reference. These numbers are typical and are

generated with a differential input voltage of 0 V when the ADC is continuously converting on a single channel. It is important to note that the effective resolution is calculated using the rms noise, whereas the peak-to-peak resolution is calculated based on peak-to-peak noise. The peak-to-peak resolution represents the resolution for which there is no code flicker.

SINC⁴ CHOP DISABLED

Table 6. RMS Noise (nV) vs. Gain and Output Data Rate

Filter Word (Decimal)	Output Data Rate (Hz)	Settling Time (ms)	Gain of 1	Gain of 8	Gain of 16	Gain of 32	Gain of 64	Gain of 128
1023	4.7	852.5	280	96	50	22	10	8.5
640	7.5	533	390	120	54	28	12	10.5
480	10	400	470	130	56	31	14	11.5
96	50	80	1000	150	78	45	33	28
80	60	66.7	1100	170	88	52	36	31
32	150	26.7	1460	220	125	75	55	48
16	300	13.3	1900	285	170	100	75	67
5	960	4.17	3000	480	280	175	140	121
2	2400	1.67	5000	780	440	280	220	198
1	4800	0.83	14,300	1920	1000	550	380	295

Table 7. Peak-to-Peak Noise (nV) vs. Gain and Output Data Rate

Filter Word (Decimal)	Output Data Rate (Hz)	Settling Time (ms)	Gain of 1	Gain of 8	Gain of 16	Gain of 32	Gain of 64	Gain of 128
1023	4.7	852.5	1600	500	250	130	65	56
640	7.5	533	2200	650	290	150	80	65
480	10	400	3000	670	300	190	100	70
96	50	80	6000	900	450	280	180	170
80	60	66.7	7200	1100	480	300	220	190
32	150	26.7	8300	1500	750	410	340	310
16	300	13.3	11,000	1700	1000	600	440	430
5	960	4.17	20,000	3000	1800	1100	810	710
2	2400	1.67	32,000	5100	2800	1700	1400	1200
1	4800	0.83	86,000	13,000	6000	3500	2400	1900

Table 8. Effective Resolution (Peak-to-Peak Resolution) vs. Gain and Output Data Rate

Filter Word (Decimal)	Output Data Rate (Hz)	Settling Time (ms)	Gain of 1 ¹	Gain of 8 ¹	Gain of 16 ¹	Gain of 32 ¹	Gain of 64 ¹	Gain of 128 ¹
1023	4.7	852.5	24 (22.6)	23.6 (21.3)	23.6 (21.3)	23.6 (21.2)	23.6 (21.2)	23.1 (20.4)
640	7.5	533	24 (22.1)	23.4 (20.9)	23.4 (20.9)	23.4 (20.9)	23.4 (20.9)	22.8 (20.2)
480	10	400	24 (21.7)	23.3 (20.8)	23.3 (20.8)	23.3 (20.8)	23.3 (20.6)	22.7 (20.1)
96	50	80	23.3 (20.7)	23 (20.4)	22.9 (20.4)	22.7 (20.1)	22.2 (19.7)	21.4 (18.8)
80	60	66.7	23.1 (20.4)	22.8 (20.1)	22.8 (20)	22.5 (20)	22.1 (19.4)	21.3 (18.6)
32	150	26.7	22.7 (20.2)	22.4 (19.7)	22.3 (19.7)	22 (19.5)	21.5 (18.8)	20.6 (17.9)
16	300	13.3	22.3 (19.8)	22.1 (19.5)	21.8 (19.3)	21.6 (19)	21 (18.4)	20.1 (17.5)
5	960	4.17	21.7 (18.9)	21.3 (18.7)	21.1 (18.4)	20.8 (18.1)	20.2 (17.6)	19.3 (16.7)
2	2400	1.67	20.9 (18.3)	20.6 (17.9)	20.4 (17.7)	20.1 (17.5)	19.5 (16.8)	18.6 (16)
1	4800	0.83	19.4 (16.8)	19.3 (16.6)	19.3 (16.4)	19.1 (16.4)	18.8 (16)	18 (15.3)

¹ The output peak-to-peak (p-p) resolution is listed in parentheses.

SINC³ CHOP DISABLED

Table 9. RMS Noise (nV) vs. Gain and Output Data Rate

Filter Word (Decimal)	Output Data Rate (Hz)	Settling Time (ms)	Gain of 1	Gain of 8	Gain of 16	Gain of 32	Gain of 64	Gain of 128
1023	4.7	639.4	290	125	53	24	10.5	9
640	7.5	400	470	135	56	29	13	11.5
480	10	300	610	145	58	32	16	12.5
96	50	60	1100	160	86	50	35	29
80	60	50	1200	170	95	55	40	32
32	150	20	1500	230	130	80	58	50
16	300	10	1950	308	175	110	83	73
5	960	3.13	4000	590	330	200	150	133
2	2400	1.25	56,600	7000	3500	1800	900	490
1	4800	0.625	442,000	55,000	28,000	14,000	7000	3450

Table 10. Peak-to-Peak Noise (nV) vs. Gain and Output Data Rate

Filter Word (Decimal)	Output Data Rate (Hz)	Settling Time (ms)	Gain of 1	Gain of 8	Gain of 16	Gain of 32	Gain of 64	Gain of 128
1023	4.7	639.4	1700	750	260	140	65	56
640	7.5	400	2400	800	340	150	84	60
480	10	300	3000	900	360	200	100	70
96	50	60	6600	1000	480	290	200	180
80	60	50	6800	1100	600	300	240	200
32	150	20	8900	1400	710	470	360	310
16	300	10	13,000	2000	1000	670	470	500
5	960	3.13	25,000	3400	2200	1200	850	800
2	2400	1.25	310,000	41,000	22,000	12,000	5600	3100
1	4800	0.625	2,600,000	300,000	170,000	79,000	41,000	24,000

Table 11. Effective Resolution (Peak-to-Peak Resolution) vs. Gain and Output Data Rate

Filter Word (Decimal)	Output Data Rate (Hz)	Settling Time (ms)	Gain of 1 ¹	Gain of 8 ¹	Gain of 16 ¹	Gain of 32 ¹	Gain of 64 ¹	Gain of 128 ¹
1023	4.7	639.4	24 (22.5)	23.5 (21)	23.5 (21)	23.5 (21)	23.5 (21)	23 (20.4)
640	7.5	400	24 (22)	23.3 (20.8)	23.3 (20.8)	23.3 (20.8)	23.3 (20.8)	22.7 (20.3)
480	10	300	24 (22)	23.2 (20.5)	23.2 (20.5)	23.2 (20.5)	23.2 (20.5)	22.6 (20.1)
96	50	60	23.1 (20.5)	22.9 (20.3)	22.8 (20.3)	22.6 (20)	22.1 (19.6)	21.4 (18.7)
80	60	50	23 (20.5)	22.8 (20.1)	22.6 (20)	22.4 (20)	21.9 (19.3)	21.2 (18.6)
32	150	20	22.7 (20)	22.4 (19.8)	22.2 (19.7)	21.9 (19.3)	21.4 (18.7)	20.6 (17.9)
16	300	10	22.3 (19.5)	22 (19.3)	21.8 (19.3)	21.4 (18.8)	20.8 (18.3)	20 (17.3)
5	960	3.13	21.3 (18.5)	21 (18.5)	20.9 (18.1)	20.6 (18)	20 (17.5)	19.2 (16.6)
2	2400	1.25	17.4 (14.9)	17.4 (14.9)	17.4 (14.8)	17.4 (14.7)	17.4 (14.7)	17.3 (14.6)
1	4800	0.625	14.5 (11.9)	14.5 (11.9)	14.4 (11.8)	14.4 (11.8)	14.4 (11.8)	14.4 (11.7)

¹ The output peak-to-peak (p-p) resolution is listed in parentheses.

SINC⁴ CHOP ENABLED**Table 12. RMS Noise (nV) vs. Gain and Output Data Rate**

Filter Word (Decimal)	Output Data Rate (Hz)	Settling Time (ms)	Gain of 1	Gain of 8	Gain of 16	Gain of 32	Gain of 64	Gain of 128
1023	1.175	1702	198	85	41	18	7	6
640	1.875	1067	276	92	45	22	8.5	7
480	2.5	800	332	99	46	23	10	8
96	12.5	160	707	127	61	34	23	18
80	15	133	778	141	62	35	24	21
32	37.5	53.3	990	156	85	51	38	33
16	75	26.7	1344	191	106	67	51	45
5	240	8.33	2192	325	184	120	92	78
2	600	3.33	3606	523	297	191	148	134
1	1200	1.67	9900	1345	680	368	248	200

Table 13. Peak-to-Peak Noise (nV) vs. Gain and Output Data Rate

Filter Word (Decimal)	Output Data Rate (Hz)	Settling Time (ms)	Gain of 1	Gain of 8	Gain of 16	Gain of 32	Gain of 64	Gain of 128
1023	1.175	1702	1131	474	212	92	46	40
640	1.875	1067	1556	495	248	106	57	46
480	2.5	800	2121	530	255	134	71	50
96	12.5	160	4243	707	368	198	127	120
80	15	133	5091	849	424	212	156	134
32	37.5	53.3	5870	1061	530	290	240	219
16	75	26.7	7780	1202	707	424	311	304
5	240	8.33	14,142	2121	1273	778	573	502
2	600	3.33	22,627	3606	1980	1202	990	850
1	1200	1.67	60,800	9192	4950	2475	1697	1345

Table 14. Effective Resolution (Peak-to-Peak Resolution) vs. Gain and Output Data Rate

Filter Word (Decimal)	Output Data Rate (Hz)	Settling Time (ms)	Gain of 1 ¹	Gain of 8 ¹	Gain of 16 ¹	Gain of 32 ¹	Gain of 64 ¹	Gain of 128 ¹
1023	1.175	1702	24 (23.1)	24 (21.8)	24 (21.8)	24 (21.7)	24 (21.7)	23.6 (20.9)
640	1.875	1067	24 (22.6)	23.9 (21.4)	23.9 (21.4)	23.9 (21.4)	23.9 (21.4)	23.3 (20.7)
480	2.5	800	24 (22.2)	23.8 (21.3)	23.8 (21.3)	23.8 (21.3)	23.8 (21.1)	23.2 (20.6)
96	12.5	160	23.8 (21.2)	23.5 (20.9)	23.4 (20.9)	23.2 (20.6)	22.7 (20.2)	21.9 (19.3)
80	15	133	23.6 (20.9)	23.3 (20.6)	23.3 (20.5)	23 (20.5)	22.6 (19.9)	21.8 (19.1)
32	37.5	53.3	23.2 (20.7)	22.9 (20.2)	22.8 (20.2)	22.5 (20)	22 (19.3)	21.1 (18.4)
16	75	26.7	22.8 (20.3)	22.6 (20)	22.3 (19.8)	22.1 (19.5)	21.5 (18.9)	20.6 (18)
5	240	8.33	22.2 (19.4)	21.8 (19.2)	21.6 (18.9)	21.3 (18.6)	20.7 (18.1)	19.8 (17.2)
2	600	3.33	21.4 (18.8)	21.1 (18.4)	20.9 (18.2)	20.6 (18)	20 (17.3)	19.1 (16.5)
1	1200	1.67	19.9 (17.3)	19.8 (17.1)	19.8 (16.9)	19.6 (16.9)	19.3 (16.5)	18.5 (15.8)

¹ The output peak-to-peak (p-p) resolution is listed in parentheses.

When ac excitation is enabled, the rms noise and resolution is the same as for chop enabled mode.

SINC³ CHOP ENABLED

Table 15. RMS Noise (nV) vs. Gain and Output Data Rate

Filter Word (Decimal)	Output Data Rate (Hz)	Settling Time (ms)	Gain of 1	Gain of 8	Gain of 16	Gain of 32	Gain of 64	Gain of 128
1023	1.56	1282	205	88	37	17	7.5	6.5
640	2.5	800	332	95	40	21	9	8
480	3.33	600	431	103	41	23	11.5	9
96	16.6	120	778	113	61	35	25	21
80	20	100	849	120	67	39	28	23
32	50	40	1061	163	92	57	41	35
16	100	20	1379	218	124	78	59	52
5	320	6.25	2828	417	233	141	106	94
2	800	2.5	40,022	4950	2475	1273	636	346
1	1600	1.25	312,540	38,890	19,800	9900	4950	2440

Table 16. Peak-to-Peak Noise (nV) vs. Gain and Output Data Rate

Filter Word (Decimal)	Output Data Rate (Hz)	Settling Time (ms)	Gain of 1	Gain of 8	Gain of 16	Gain of 32	Gain of 64	Gain of 128
1023	1.56	1282	1202	530	184	92	46	40
640	2.5	800	1697	566	240	120	59	42
480	3.33	600	2121	636	255	141	71	49
96	16.6	120	4667	686	318	198	141	127
80	20	100	4808	707	424	205	170	141
32	50	40	6293	990	474	382	255	219
16	100	20	9192	1414	707	474	332	354
5	320	6.25	17,680	2404	1556	849	601	566
2	800	2.5	219,200	29,000	15,560	8485	3960	2192
1	1600	1.25	1,838,500	212,200	120,200	55,870	29,000	16,970

Table 17. Effective Resolution (Peak-to-Peak Resolution) vs. Gain and Output Data Rate

Filter Word (Decimal)	Output Data Rate (Hz)	Settling Time (ms)	Gain of 1 ¹	Gain of 8 ¹	Gain of 16 ¹	Gain of 32 ¹	Gain of 64 ¹	Gain of 128 ¹
1023	1.56	1282	24 (23)	24 (21.5)	24 (21.5)	24 (21.5)	24 (21.5)	23.5 (20.9)
640	2.5	800	24 (22.5)	23.8 (21.3)	23.8 (21.3)	23.8 (21.3)	23.8 (21.3)	23.2 (20.8)
480	3.33	600	24 (22.5)	23.7 (21)	23.7 (21)	23.7 (21)	23.7 (21)	23.1 (20.6)
96	16.6	120	23.6 (21)	23.4 (20.8)	23.3 (20.8)	23.1 (20.5)	22.6 (20.1)	21.9 (19.2)
80	20	100	23.5 (21)	23.3 (20.6)	23.1 (20.5)	22.9 (20.5)	22.4 (19.8)	21.7 (19.1)
32	320	40	23.2 (20.5)	22.9 (20.3)	22.7 (20.2)	22.4 (19.8)	21.9 (19.2)	21.1 (18.4)
16	100	20	22.8 (20)	22.5 (19.8)	22.3 (19.8)	21.9 (19.3)	21.3 (18.8)	20.5 (17.8)
5	320	6.25	21.8 (19)	21.5 (19)	21.4 (18.6)	21.1 (18.5)	20.5 (18)	19.7 (17.1)
2	800	2.5	17.9 (15.4)	17.9 (15.4)	17.9 (15.3)	17.9 (15.2)	17.9 (15.2)	17.8 (15.1)
1	1600	1.25	15 (12.4)	15 (12.4)	14.9 (12.3)	14.9 (12.3)	14.9 (12.3)	14.9 (12.2)

¹ The output peak-to-peak (p-p) resolution is listed in parentheses.

When ac excitation is enabled, the rms noise and resolution is the same as for chop enabled mode.

ON-CHIP REGISTERS

The ADC is controlled and configured via a number of on-chip registers described on the following pages. In the following descriptions, the term set implies a Logic 1 state and cleared implies a Logic 0 state, unless otherwise noted.

Table 18. Register Summary

Register	Addr.	Dir.	Default	Bit 7	Bit 6	Bit 5	Bit 4	Bit 3	Bit 2	Bit 1	Bit 0
Communications	00	W	00	WEN	R/W	Register address			CREAD	0	0
Status	00	R	80	RDY	ERR	NOREF	PARITY	0	CHD2	CHD1	CHD0
Mode	01	R/W	080060	Mode select			DAT_STA	CLK1	CLK0	0	0
				SINC3	0	ENPAR	0	SINGLE	REJ60	FS9	FS8
				FS7	FS6	FS5	FS4	FS3	FS2	FS1	FS0 (LSB)
Configuration	02	R/W	000117	Chop (MSB)	ACX	0	0	0	0	0	0
				CH7	CH6	CH5	CH4	CH3	CH2	CH1	CH0
				BURN	REFDET	0	BUF	U/B	G2	G1	G0 (LSB)
Data	03	R	000000	D23 (MSB)	D22	D21	D20	D19	D18	D17	D16
				D15	D14	D13	D12	D11	D10	D9	D8
				D7	D6	D5	D4	D3	D2	D1	D0 (LSB)
ID	04	R	A6	1	0	1	0	0	1	1	0
GPOCON	05	R/W	00	0	BPDSW	0	0	0	0	0	0
Offset	06	R/W	800000	OF23 (MSB)	OF22	OF21	OF20	OF19	OF18	OF17	OF16
				OF15	OF14	OF13	OF12	OF11	OF10	OF9	OF8
				OF7	OF6	OF5	OF4	OF3	OF2	OF1	OF0 (LSB)
Full Scale	07	R/W	5XXXX0	FS23 (MSB)	FS22	FS21	FS20	FS19	FS18	FS17	FS16
				FS15	FS14	FS13	FS12	FS11	FS10	FS9	FS8
				FS7	FS6	FS5	FS4	FS3	FS2	FS1	FS0 (LSB)

COMMUNICATIONS REGISTER**(RS2, RS1, RS0 = 0, 0, 0)**

The communications register is an 8-bit write-only register. All communications to the part must start with a write operation to the communications register. The data written to the communications register determines whether the next operation is a read or a write operation and in which register this operation takes place. For read or write operations, when the subsequent read or write operation to the selected register is complete, the interface returns to where it expects a write operation to the communications register. This is the default

state of the interface and, on power-up or after a reset, the ADC is in this default state waiting for a write operation to the communications register. In situations where the interface sequence is lost, a write operation of at least 40 serial clock cycles with DIN high returns the ADC to this default state by resetting the entire part. Table 19 outlines the bit designations for the communications register. CR0 through CR7 indicate the bit location, CR denoting that the bits are in the communications register. CR7 denotes the first bit of the data stream. The number in parentheses indicates the power-on/reset default status of that bit.

CR7	CR6	CR5	CR4	CR3	CR2	CR1	CR0
WEN(0)	R/W(0)	RS2(0)	RS1(0)	RS0(0)	CREAD(0)	0	0

Table 19. Communications Register Bit Designations

Bit Location	Bit Name	Description
CR7	WEN	Write enable bit. For a write to the communications register to occur, 0 must be written to this bit. If a 1 is the first bit written, the part does not clock on to subsequent bits in the register; rather, it stays at this bit location until a 0 is written to this bit. After a 0 is written to the WEN bit, the next seven bits are loaded to the communications register. Idling the DIN pin high between data transfers minimizes the effects of spurious SCLK pulses on the serial interface.
CR6	R/W	A 0 in this bit location indicates that the next operation is a write to a specified register. A 1 in this position indicates that the next operation is a read from the designated register.
CR5 to CR3	RS2 to RS0	Register address bits. These address bits are used to select which registers of the ADC are selected during the serial interface communication (see Table 20).
CR2	CREAD	Continuous read of the data register. When this bit is set to 1 (and the data register is selected), the serial interface is configured so that the data register can be continuously read; that is, the contents of the data register are automatically placed on the DOUT pin when the SCLK pulses are applied after the RDY pin goes low to indicate that a conversion is complete. The communications register does not have to be written to for subsequent data reads. To enable continuous read, the Instruction 01011100 must be written to the communications register. To disable continuous read, the Instruction 01011000 must be written to the communications register while the RDY pin is low. While continuous read is enabled, the ADC monitors activity on the DIN line so that it can receive the instruction to disable continuous read. Additionally, a reset occurs if 40 consecutive 1s are seen on DIN. Therefore, hold DIN low until an instruction is written to the device.
CR1 to CR0	0	These bits must be programmed to Logic 0 for correct operation.

Table 20. Register Selection

RS2	RS1	RS0	Register	Register Size
0	0	0	Communications register during a write operation	8 bits
0	0	0	Status register during a read operation	8 bits
0	0	1	Mode register	24 bits
0	1	0	Configuration register	24 bits
0	1	1	Data register/data register plus status information	24 bits/32 bits
1	0	0	ID register	8 bits
1	0	1	GPOCON register	8 bits
1	1	0	Offset register	24 bits
1	1	1	Full-scale register	24 bits

STATUS REGISTER**(RS2, RS1, RS0 = 0, 0, 0; Power-On/Reset = 0x80)**

The status register is an 8-bit read-only register. To access the ADC status register, the user must write to the communications register, select the next operation to be a read, and load Bit RS2, Bit RS1, and Bit RS0 with 0. Table 21 outlines the bit designations for the status register. SR0 through SR7 indicate the bit locations, SR denoting that the bits are in the status register. SR7 denotes the first bit of the data stream. The number in parentheses indicates the power-on/reset default status of that bit.

SR7	SR6	SR5	SR4	SR3	SR2	SR1	SR0
RDY(1)	ERR(0)	NOREF(0)	PARITY(0)	0	CHD2(0)	CHD1(0)	CHD0(0)

Table 21. Status Register Bit Designations

Bit Location	Bit Name	Description
SR7	RDY	Ready bit for the ADC. This bit is cleared when data is written to the ADC data register. The $\overline{\text{RDY}}$ bit is set automatically after the ADC data register is read, or a period of time before the data register is updated, with a new conversion result to indicate to the user that the conversion data should not be read. It is also set when the part is placed in power-down mode or idle mode or when SYNC is taken low. The end of a conversion is also indicated by the DOUT/RDY pin. This pin can be used as an alternative to the status register for monitoring the ADC for conversion data.
SR6	ERR	ADC error bit. This bit is written to at the same time as the $\overline{\text{RDY}}$ bit. This bit is set to indicate that the result written to the ADC data register is clamped to all 0s or all 1s. Error sources include overrange or under-range, or the absence of a reference voltage. This bit is cleared when the result written to the data register is within the allowed analog input range again.
SR5	NOREF	No external reference bit. This bit is set to indicate that the reference is at a voltage that is below a specified threshold. When set, conversion results are clamped to all 1s. This bit is cleared to indicate that a valid reference is applied to the selected reference pins. The NOREF bit is enabled by setting the REFDET bit in the configuration register to 1.
SR4	PARITY	Parity check of the data register. If the ENPAR bit in the mode register is set, the PARITY bit is set if there is an odd number of 1s in the data register. It is cleared if there is an even number of 1s in the data register. The DAT_STA bit in the mode register should be set when the parity check is used. When the DAT_STA bit is set, the contents of the status register are transmitted along with the data for each data register read.
SR3	0	This bit is set to 0.
SR2 to SR0	CHD2 to CHD0	These bits indicate which channel corresponds to the data register contents. They do not indicate which channel is presently being converted but indicate which channel was selected when the conversion contained in the data register was generated.

MODE REGISTER**(RS2, RS1, RS0 = 0, 0, 1; Power-On/Reset = 0x080060)**

The mode register is a 24-bit register from which data can be read or to which data can be written. This register is used to select the operating mode, the output data rate, and the clock source. Table 22 outlines the bit designations for the mode register. MR0 through MR23 indicate the bit locations, MR denoting that the bits are in the mode register. MR23 denotes the first bit of the data stream. The number in parentheses indicates the power-on/reset default status of that bit. Any write to the mode register resets the modulator and filter and sets the RDY bit.

MR23	MR22	MR21	MR20	MR19	MR18	MR17	MR16
MD2(0)	MD1(0)	MD0(0)	DAT_STA(0)	CLK1(1)	CLK0(0)	0	0
MR15	MR14	MR13	MR12	MR11	MR10	MR9	MR8
SINC3(0)	0	ENPAR(0)	0	SINGLE(0)	REJ60(0)	FS9(0)	FS8(0)
MR7	MR6	MR5	MR4	MR3	MR2	MR1	MR0
FS7(0)	FS6(1)	FS5(1)	FS4(0)	FS3(0)	FS2(0)	FS1(0)	FS0(0)

Table 22. Mode Register Bit Designations

Bit Location	Bit Name	Description
MR23 to MR21	MD2 to MD0	Mode select bits. These bits select the operating mode of the AD7195 (see Table 23).
MR20	DAT_STA	This bit enables the transmission of status register contents after each data register read. When DAT_STA is set, the contents of the status register are transmitted along with each data register read. This function is useful when several channels are selected because the status register identifies the channel to which the data register value corresponds.
MR19, MR18	CLK1, CLK0	These bits select the clock source for the AD7195. Either the on-chip 4.92 MHz clock or an external clock can be used. The ability to use an external clock allows several AD7195 devices to be synchronized. Also, 50 Hz/60 Hz rejection is improved when an accurate external clock drives the AD7195.
		CLK1 CLK0 ADC Clock Source
		0 0 External crystal. The external crystal is connected from MCLK1 to MCLK2.
		0 1 External clock. The external clock is applied to the MCLK2 pin.
		1 0 Internal 4.92 MHz clock. Pin MCLK2 is tristated.
1 1 Internal 4.92 MHz clock. The internal clock is available on MCLK2.		
MR17, MR16	0	These bits must be programmed with a Logic 0 for correct operation.
MR15	SINC3	Sinc ³ filter select bit. When this bit is cleared, the sinc ⁴ filter is used (default value). When this bit is set, the sinc ³ filter is used. The benefit of the sinc ³ filter compared to the sinc ⁴ filter is its lower settling time. For a given output data rate, f_{ADC} , the sinc ³ filter has a settling time of $3/f_{ADC}$ while the sinc ⁴ filter has a settling time of $4/f_{ADC}$ when chop is disabled. The sinc ⁴ filter, due to its deeper notches, gives better 50 Hz/60 Hz rejection. At low output data rates, both filters give similar rms noise and similar no missing codes for a given output data rate. At higher output data rates (FS values less than 5), the sinc ⁴ filter gives better performance than the sinc ³ filter for rms noise and no missing codes.
MR14	0	This bit must be programmed with a Logic 0 for correct operation.
MR13	ENPAR	Enable parity bit. When ENPAR is set, parity checking on the data register is enabled. The DAT_STA bit in the mode register should be set when the parity check is used. When the DAT_STA bit is set, the contents of the status register are transmitted along with the data for each data register read.
MR12	0	This bit must be programmed with a Logic 0 for correct operation.
MR11	SINGLE	Single cycle conversion enable bit. When this bit is set, the AD7195 settles in one conversion cycle so that it functions as a zero-latency ADC. This bit has no effect when multiple analog input channels are enabled or when the single conversion mode is selected.
MR10	REJ60	This bit enables a notch at 60 Hz when the first notch of the sinc filter is at 50 Hz. When REJ60 is set, a filter notch is placed at 60 Hz when the sinc filter first notch is at 50 Hz. This allows simultaneous 50 Hz/60 Hz rejection.
MR9 to MR0	FS9 to FS0	Filter output data rate select bits. The 10 bits of data programmed into these bits determine the filter cut-off frequency, the position of the first notch of the filter, and the output data rate for the part. In association with the gain selection, they also determine the output noise (and, therefore, the effective resolution) of the device (see Table 6 through Table 17). When chop is disabled and continuous conversion mode is selected, $\text{Output Data Rate} = (MCLK/1024)/FS$ where FS is the decimal equivalent of the code in Bit FS0 to Bit FS9 and is in the range 1 to 1023, and $MCLK$ is the master clock frequency. With a nominal $MCLK$ of 4.92 MHz, this results in an output data rate from 4.69 Hz to 4.8 kHz. With chop disabled, the first notch frequency is equal to the output data rate when converting on a single channel. When chop is enabled, $\text{Output Data Rate} = (MCLK/1024)/(N \times FS)$ where FS is the decimal equivalent of the code in Bit FS0 to Bit FS9 and is in the range 1 to 1023, and $MCLK$ is the master clock frequency. With a nominal $MCLK$ of 4.92 MHz, this results in a conversion rate from 4.69/N Hz to 4.8/N kHz, where N is the order of the sinc filter. The sinc filter's first notch frequency is equal to $N \times$ output data rate. The chopping introduces notches at odd integer multiples of (output data rate/2).

Table 23. Operating Modes

MD2	MD1	MD0	Mode
0	0	0	Continuous conversion mode (default). In continuous conversion mode, the ADC continuously performs conversions and places the result in the data register. The DOUT/RDY pin and the RDY bit in the status register go low when a conversion is complete. The user can read these conversions by setting the CREAD bit in the communications register to 1, which enables continuous read. When continuous read is enabled, the conversions are automatically placed on the DOUT line when SCLK pulses are applied. Alternatively, the user can instruct the ADC to output each conversion by writing to the communications register. After power-on, a reset, or a reconfiguration of the ADC, the complete settling time of the filter is required to generate the first valid conversion. Subsequent conversions are available at the selected output data rate, which is dependent on filter choice.
0	0	1	Single conversion mode. When single conversion mode is selected, the ADC powers up and performs a single conversion on the selected channel. The internal clock requires up to 1 ms to power up and settle. The ADC then performs the conversion, which requires the complete settling time of the filter. The conversion result is placed in the data register. RDY goes low, and the ADC returns to power-down mode. The conversion remains in the data register until another conversion is performed. RDY remains active (low) until the data is read or another conversion is performed.
0	1	0	Idle mode. In idle mode, the ADC filter and modulator are held in a reset state even though the modulator clocks are still provided.
0	1	1	Power-down mode. In power-down mode, all AD7195 circuitry, except the bridge power-down switch, is powered down. The bridge power-down switch remains active because the user may need to power up the sensor prior to powering up the AD7195 for settling reasons. The external crystal, if selected, remains active.
1	0	0	Internal zero-scale calibration. An internal short is automatically connected to the input. RDY goes high when the calibration is initiated and returns low when the calibration is complete. The ADC is placed in idle mode following a calibration. The measured offset coefficient is placed in the offset register of the selected channel.
1	0	1	Internal full-scale calibration. A full-scale input voltage is automatically connected to the input for this calibration. RDY goes high when the calibration is initiated and returns low when the calibration is complete. The ADC is placed in idle mode following a calibration. The measured full-scale coefficient is placed in the full-scale register of the selected channel. A full-scale calibration is required each time the gain of a channel is changed to minimize the full-scale error.
1	1	0	System zero-scale calibration. The user should connect the system zero-scale input to the channel input pins as selected by the CH7 to CH0 bits in the configuration register. RDY goes high when the calibration is initiated and returns low when the calibration is complete. The ADC is placed in idle mode following a calibration. The measured offset coefficient is placed in the offset register of the selected channel. A system zero-scale calibration is required each time the gain of a channel is changed.
1	1	1	System full-scale calibration. The user should connect the system full-scale input to the channel input pins as selected by the CH7 to CH0 bits in the configuration register. RDY goes high when the calibration is initiated and returns low when the calibration is complete. The ADC is placed in idle mode following a calibration. The measured full-scale coefficient is placed in the full-scale register of the selected channel. A full-scale calibration is required each time the gain of a channel is changed.

CONFIGURATION REGISTER

(RS2, RS1, RS0 = 0, 1, 0; Power-On/Reset = 0x000117)

The configuration register is a 24-bit register from which data can be read or to which data can be written. This register is used to configure the ADC for unipolar or bipolar mode, to enable or disable the buffer, to enable or disable the burnout currents, to select the gain, and to select the analog input channel. Table 24 outlines the bit designations for the filter register. CON0 through CON23 indicate the bit locations. CON denotes that the bits are in the configuration register. CON23 denotes the first bit of the data stream. The number in parentheses indicates the power-on/reset default status of that bit.

CON23	CON22	CON21	CON20	CON19	CON18	CON17	CON16
CHOP(0)	ACX(0)	0	0	0	0	0	0
CON15	CON14	CON13	CON12	CON11	CON10	CON9	CON8
CH7(0)	CH6(0)	CH5(0)	CH4(0)	CH3(0)	CH2(0)	CH1(0)	CH0(1)
CON7	CON6	CON5	CON4	CON3	CON2	CON1	CON0
BURN(0)	REFDET(0)	0	BUF(1)	U/B (0)	G2(1)	G1(1)	G0(1)

Table 24. Configuration Register Bit Designations

Bit Location	Bit Name	Description																																													
CON23	CHOP	Chop enable bit. When the CHOP bit is cleared, chop is disabled. When the CHOP bit is set, chop is enabled. When chop is enabled, the offset and offset drift of the ADC are continuously removed. However, this increases the conversion time and settling time of the ADC. For example, when FS = 96 decimal and the sinc ⁴ filter is selected, the conversion time with chop enabled equals 80 ms and the settling time equals 160 ms. With chop disabled, higher conversion rates are allowed. For an FS word of 96 decimal and the sinc ⁴ filter selected, the conversion time is 20 ms and the settling time is 80 ms. However, at low gains, periodic calibrations may be required to remove the offset and offset drift. When an excitation is enabled, chop must be enabled also.																																													
CON22	ACX	AC excitation enable bit. If the signal source to the AD7195 is ac excited, this bit must be set to 1. For dc-excited inputs, this bit must be 0. With the ACX bit at 1, the AD7195 assumes that the voltage at the AIN(+)/AIN(-) and REFIN(+)/REFIN(-) input terminals are reversed on alternate input sampling cycles (that is, chopped). Note that when the AD7195 is performing internal zero-scale or full-scale calibrations, the ACX bit is treated as a 0, that is, the device performs these self-calibrations with dc excitation. TheBitCHOP must be set to 1 when ac excitation is enabled.																																													
CON21 to CON16	0	These bits must be programmed with a Logic 0 for correct operation.																																													
CON15 to CON8	CH7 to CH0	Channel select bits. These bits are used to select which channels are enabled on the AD7195 (see Table 25). Several channels can be selected, and the AD7195 automatically sequences them. The conversion on each channel requires the complete settling time. When performing calibrations or when accessing the calibration registers, only one channel can be selected.																																													
CON7	BURN	When this bit is set to 1, the 500 nA current sources in the signal path are enabled. When BURN = 0, the burnout currents are disabled. The burnout currents can be enabled only when the buffer is active and when chop is disabled.																																													
CON6	REFDET	Enables the reference detect function. When set, the NOREF bit in the status register indicates when the external reference being used by the ADC is open circuit or less than 0.6 V maximum. The reference detect circuitry operates only when the ADC is active.																																													
CON5	0	This bit must be programmed with a Logic 0 for correct operation.																																													
CON4	BUF	Enables the buffer on the analog inputs. If cleared, the analog inputs are unbuffered, lowering the power consumption of the device. If this bit is set, the analog inputs are buffered, allowing the user to place source impedances on the front end without contributing gain errors to the system. With the buffer disabled, the voltage on the analog input pins can be from 50 mV below AGND to 50 mV above AV _{DD} . When the buffer is enabled, it requires some headroom; therefore, the voltage on any input pin must be limited to 250 mV within the power supply rails.																																													
CON3	U/ \bar{B}	Polarity select bit. When this bit is set, unipolar operation is selected. When this bit is cleared, bipolar operation is selected.																																													
CON2 to CON0	G2 to G0	Gain select bits. These bits are written by the user to select the ADC input range as follows:																																													
		<table border="1"> <thead> <tr> <th>G2</th> <th>G1</th> <th>G0</th> <th>Gain</th> <th>ADC Input Range (5 V Reference)</th> </tr> </thead> <tbody> <tr> <td>0</td> <td>0</td> <td>0</td> <td>1</td> <td>±5 V</td> </tr> <tr> <td>0</td> <td>0</td> <td>1</td> <td>Reserved</td> <td></td> </tr> <tr> <td>0</td> <td>1</td> <td>0</td> <td>Reserved</td> <td></td> </tr> <tr> <td>0</td> <td>1</td> <td>1</td> <td>8</td> <td>±625 mV</td> </tr> <tr> <td>1</td> <td>0</td> <td>0</td> <td>16</td> <td>±312.5 mV</td> </tr> <tr> <td>1</td> <td>0</td> <td>1</td> <td>32</td> <td>±156.2 mV</td> </tr> <tr> <td>1</td> <td>1</td> <td>0</td> <td>64</td> <td>±78.125 mV</td> </tr> <tr> <td>1</td> <td>1</td> <td>1</td> <td>128</td> <td>±39.06 mV</td> </tr> </tbody> </table>	G2	G1	G0	Gain	ADC Input Range (5 V Reference)	0	0	0	1	±5 V	0	0	1	Reserved		0	1	0	Reserved		0	1	1	8	±625 mV	1	0	0	16	±312.5 mV	1	0	1	32	±156.2 mV	1	1	0	64	±78.125 mV	1	1	1	128	±39.06 mV
G2	G1	G0	Gain	ADC Input Range (5 V Reference)																																											
0	0	0	1	±5 V																																											
0	0	1	Reserved																																												
0	1	0	Reserved																																												
0	1	1	8	±625 mV																																											
1	0	0	16	±312.5 mV																																											
1	0	1	32	±156.2 mV																																											
1	1	0	64	±78.125 mV																																											
1	1	1	128	±39.06 mV																																											

Table 25. Channel Selection

Channel Enable Bits in the Configuration Register								Channel Enabled		Status Register Bits CHD[2:0]	Calibration Register Pair
CH7	CH6	CH5	CH4	CH3	CH2	CH1	CH0	Positive Input AIN(+)	Negative Input AIN(-)		
						1	1	AIN1	AIN2	000	0
					1			AIN3	AIN4	001	1
				1				Temperature sensor		010	None
			1					AIN2	AIN2	011	0
		1						AIN1	AINCOM	100	0
	1							AIN2	AINCOM	101	1
								AIN3	AINCOM	110	2
1								AIN4	AINCOM	111	3

DATA REGISTER

(RS2, RS1, RS0 = 0, 1, 1; Power-On/Reset = 0x000000)

The conversion result from the ADC is stored in this data register. This is a read-only, 24-bit register. On completion of a read operation from this register, the RDY pin/bit is set. When the DAT_STA bit in the mode register is set to 1, the contents of the status register are appended to each 24-bit conversion. This is advisable when several analog input channels are enabled because the three LSBs of the status register (CHD2 to CHD0) identify the channel from which the conversion originated.

ID REGISTER

(RS2, RS1, RS0 = 1, 0, 0; Power-On/Reset = 0xA6)

The identification number for the AD7195 is stored in the ID register. This is a read-only register.

GPOCON REGISTER

(RS2, RS1, RS0 = 1, 0, 1; Power-On/Reset = 0x00)

The GPOCON register is an 8-bit register from which data can be read or to which data can be written. This register is used to enable the general-purpose digital outputs.

Table 26 outlines the bit designations for the GPOCON register. GP0 through GP7 indicate the bit locations. GP denotes that the bits are in the GPOCON register. GP7 denotes the first bit of the data stream. The number in parentheses indicates the power-on/reset default status of that bit.

GP7	GP6	GP5	GP4	GP3	GP2	GP1	GP0
0	BPDSW(0)	0	0	0	0	0	0

Table 26. Register Bit Designations

Bit Location	Bit Name	Description
GP7	0	This bit must be programmed with a Logic 0 for correct operation.
GP 6	BPDSW	Bridge power-down switch control bit. This bit is set by the user to close the bridge power-down switch BPDSW to AGND. The switch can sink up to 30 mA. The bit is cleared by the user to open the bridge power-down switch. When the ADC is placed in power-down mode, the bridge power-down switch remains active.
GP5 to GP0	0	These bits must be programmed with a Logic 0 for correct operation.

OFFSET REGISTER***(RS2, RS1, RS0 = 1, 1, 0; Power-On/Reset = 0x800000)***

The offset register holds the offset calibration coefficient for the ADC. The power-on reset value of the offset register is 0x800000. The AD7195 has four offset registers; therefore, each channel has a dedicated offset register (see Table 25). Each of these registers is a 24-bit read/write register. This register is used in conjunction with its associated full-scale register to form a register pair. The power-on reset value is automatically overwritten if an internal or system zero-scale calibration is initiated by the user. The AD7195 must be placed in power-down mode or idle mode when writing to the offset register.

FULL-SCALE REGISTER***(RS2, RS1, RS0 = 1, 1, 1; Power-On/Reset = 0x5XXXX0)***

The full-scale register is a 24-bit register that holds the full-scale calibration coefficient for the ADC. The AD7195 has four full-scale registers; therefore, each channel has a dedicated full-scale register (see Table 25). The full-scale registers are read/write registers. However, when writing to the full-scale registers, the ADC must be placed in power-down mode or idle mode. These registers are configured at power-on with factory-calibrated full-scale calibration coefficients, the calibration being performed at gain = 1. Therefore, every device has different default coefficients. The default value is automatically overwritten if an internal or system full-scale calibration is initiated by the user or if the full-scale register is written to.

ADC CIRCUIT INFORMATION

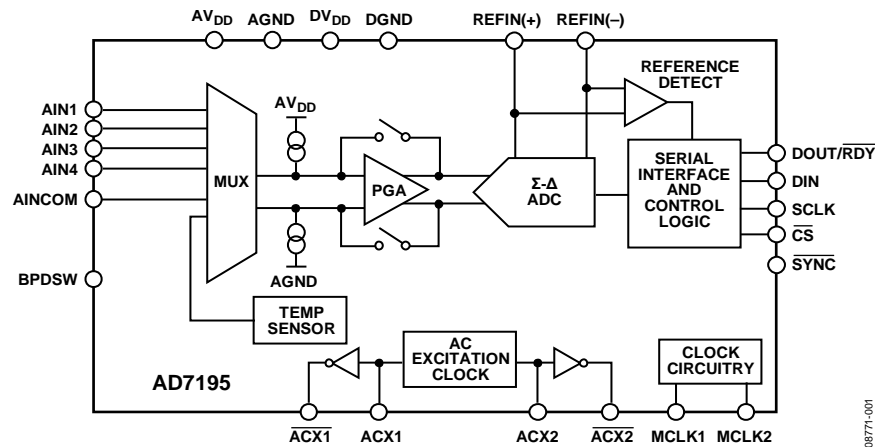

Figure 18. Block Diagram

OVERVIEW

The AD7195 is an ultralow noise ADC that incorporates a Σ - Δ modulator, a buffer, PGA, and on-chip digital filtering intended for the measurement of wide dynamic range signals, such as those in pressure transducers, weigh scales, and strain gage applications. Figure 18 shows the block diagram for the part.

Analog Inputs

The device can be configured to have two differential or four pseudo differential analog inputs. The analog inputs can be buffered or unbuffered.

Multiplexer

The on-chip multiplexer increases the channel count of the device. Because the multiplexer is included on chip, any channel changes are synchronized with the conversion process.

PGA

The analog input signal can be amplified using the PGA. The PGA allows gains of 1, 8, 16, 32, 64, and 128.

Reference Detect

The AD7195 is capable of monitoring the external reference. If the reference is not present, a flag is set in the status register of the device.

Burnout Currents

Two 500 nA burnout currents are included on-chip to detect the presence of the external sensor.

Σ - Δ ADC and Filter

The AD7195 contains a fourth-order Σ - Δ modulator followed by a digital filter. The device offers the following filter options:

- Sinc⁴
- Sinc³
- Chop enabled/disabled
- Zero latency

AC Excitation

The AD7195 supports ac excitation of load cells. It provides the four logic outputs needed to control the transistors in an ac excited load cell design.

Serial Interface

The AD7195 has a 4-wire SPI. The on-chip registers are accessed via the serial interface.

Clock

The AD7195 has an internal 4.92 MHz clock. Either this clock or an external clock can be used as the clock source to the AD7195. The internal clock can also be made available on a pin if a clock source is required for external circuitry.

Temperature Sensor

The on-chip temperature sensor monitors the die temperature.

Calibration

Both internal and system calibration are included on chip; thus, the user has the option of removing offset/gain errors internal to the AD7195 only, or removing the offset/gain errors of the complete end system.

ANALOG INPUT CHANNEL

The AD7195 has two differential/four pseudo differential analog input channels, which can be buffered or unbuffered. In buffered mode (the BUF bit in the configuration register is set to 1), the input channel feeds into a high impedance input stage of the buffer amplifier. Therefore, the input can tolerate significant source impedances and is tailored for direct connection to external resistive-type sensors such as strain gages or resistance temperature detectors (RTDs).

When BUF = 0, the part operates in unbuffered mode. This results in a higher analog input current. Note that this unbuffered input path provides a dynamic load to the driving source.

Therefore, resistor/capacitor combinations on the input pins can cause gain errors, depending on the output impedance of the source that is driving the ADC input. Table 27 shows the allowable external resistance/capacitance values for unbuffered mode at a gain of 1 such that no gain error at the 20-bit level is introduced.

Table 27. External R-C Combination for No 20-Bit Gain Error

C (pF)	R (Ω)
50	1.4 k
100	850
500	300
1000	230
5000	30

The absolute input voltage range in buffered mode is restricted to a range between AGND + 250 mV and AV_{DD} – 250 mV. Care must be taken in setting up the common-mode voltage so that these limits are not exceeded. Otherwise, linearity and noise performance degrades.

The absolute input voltage in unbuffered mode includes the range between AGND – 50 mV and AV_{DD} + 50 mV. The negative absolute input voltage limit does allow the possibility of monitoring small true bipolar signals with respect to AGND.

PGA

When the gain stage is enabled, the output from the buffer is applied to the input of the PGA. The presence of the PGA means that signals of small amplitude can be gained within the AD7195 while still maintaining excellent noise performance. For example, when the gain is set to 128, the rms noise is 8.5 nV, typically, when the output data rate is 4.7 Hz, which is equivalent to 23 bits of effective resolution or 20.5 bits of noise-free resolution.

The AD7195 can be programmed to have a gain of 1, 8, 16, 32, 64, and 128 using Bit G2 to Bit G0 in the configuration register. Therefore, with an external 2.5 V reference, the unipolar ranges are from 0 mV to 19.53 mV to 0 V to 2.5 V and the bipolar ranges are from ± 19.53 mV to ± 2.5 V.

The analog input range must be limited to $\pm(AV_{DD} - 1.25 \text{ V})/\text{gain}$ because the PGA requires some headroom. Therefore, if AV_{DD} = 5 V, the maximum analog input that can be applied to the

AD7195 is 0 to 3.75 V/gain in unipolar mode or ± 3.75 V/gain in bipolar mode.

REFERENCE

The ADC has a fully differential input capability for the reference channel. The common-mode range for these differential inputs is from AGND to AV_{DD}. The reference voltage REFIN (REFIN(+) – REFIN(–)) is AV_{DD} nominal, but the AD7195 is functional with reference voltages from 1 V to AV_{DD}. In applications where the excitation (voltage or current) for the transducer on the analog input also drives the reference voltage for the part, the effect of the low frequency noise in the excitation source is removed because the application is ratiometric. If the AD7195 is used in a nonratiometric application, a low noise reference should be used.

The reference input is unbuffered; therefore, excessive R-C source impedances introduce gain errors. R-C values similar to those in Table 27 are recommended for the reference inputs. Deriving the reference input voltage across an external resistor means that the reference input sees significant external source impedance. External decoupling on the REFINx pins is not recommended in this type of circuit configuration. Conversely, if large decoupling capacitors are used on the reference inputs, there should be no resistors in series with the reference inputs.

Recommended 2.5 V reference voltage sources for the AD7195 include the ADR421 and ADR431, which are low noise references. These references tolerate decoupling capacitors on REFIN(+) without introducing gain errors in the system. Figure 19 shows the recommended connections between the ADR421 and the AD7195.

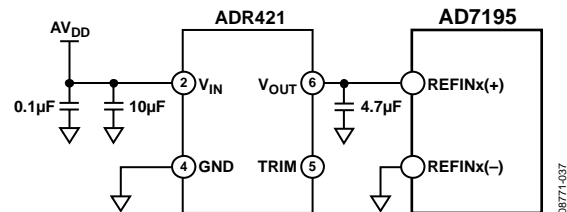

Figure 19. ADR421 to AD7195 Connections

REFERENCE DETECT

The AD7195 includes on-chip circuitry to detect whether the part has a valid reference for conversions or calibrations. This feature is enabled when the REFDET bit in the configuration register is set to 1. If the voltage between the REFIN(+) and REFIN(–) pins is between 0.3 V and 0.6 V, the AD7195 detects that it no longer has a valid reference. In this case, the NOREF bit of the status register is set to 1. If the AD7195 is performing normal conversions and the NOREF bit becomes active, the conversion result is all 1s.

Therefore, it is not necessary to continuously monitor the status of the NOREF bit when performing conversions. It is only necessary to verify its status if the conversion result read from the ADC data register is all 1s. If the AD7195 is performing either an offset or full-scale calibration and the NOREF bit becomes active, the updating of the respective calibration

registers is inhibited to avoid loading incorrect coefficients to these registers, and the ERR bit in the status register is set. If the user is concerned about verifying that a valid reference is in place every time a calibration is performed, the status of the ERR bit should be checked at the end of the calibration cycle.

BIPOLAR/UNIPOLAR CONFIGURATION

The analog input to the AD7195 can accept either unipolar or bipolar input voltage ranges. A bipolar input range does not imply that the part can tolerate negative voltages with respect to system AGND. In pseudo differential mode, signals are referenced to AINCOM while in differential mode, signals are referenced to the negative input of the differential pair. For example, if AINCOM is 2.5 V and the AD7195 AIN1 analog input is configured for unipolar mode with a gain of 2, the input voltage range on the AIN1 pin is 2.5 V to 3.75 V when a 2.5 V reference is used. If AINCOM is 2.5 V and the AD7195 AIN1 analog input is configured for bipolar mode with a gain of 2, the analog input range on AIN1 is 1.25 V to 3.75 V.

The bipolar/unipolar option is chosen by programming the $\overline{U/B}$ bit in the configuration register.

DATA OUTPUT CODING

When the ADC is configured for unipolar operation, the output code is natural (straight) binary with a zero differential input voltage resulting in a code of 00...00, a midscale voltage resulting in a code of 100...000, and a full-scale input voltage resulting in a code of 111...111. The output code for any analog input voltage can be represented as

$$\text{Code} = (2^N \times \text{AIN} \times \text{Gain}) / V_{REF}$$

When the ADC is configured for bipolar operation, the output code is offset binary with a negative full-scale voltage resulting in a code of 000...000, a zero differential input voltage resulting in a code of 100...000, and a positive full-scale input voltage resulting in a code of 111...111. The output code for any analog input voltage can be represented as

$$\text{Code} = 2^{N-1} \times [(\text{AIN} \times \text{Gain} / V_{REF}) + 1]$$

where:

$N = 24$.

AIN is the analog input voltage.

Gain is the PGA setting (1 to 128).

BURNOUT CURRENTS

The AD7195 contains two 500 nA constant current generators, one sourcing current from AV_{DD} to AIN(+) and one sinking current from AIN(−) to AGND, where AIN(+) is the positive analog input terminal and AIN(−) is the negative analog input terminal in differential mode and AINCOM in pseudo differential mode. The currents are switched to the selected analog input pair. Both currents are either on or off, depending on the burnout current enable (BURN) bit in the configuration register. These currents can be used to verify that an external transducer remains operational before attempting to take measurements on that channel. After the burnout currents are

turned on, they flow in the external transducer circuit, and a measurement of the input voltage on the analog input channel can be taken. It will take some time for the burnout currents to detect an open circuit condition as the currents will need to charge any external capacitors

There are several reasons why a fault condition might be detected. The front-end sensor may be open circuit. The front-end sensor may be overloaded, or the reference may be absent and the NOREF bit in the status register is set, thus clamping the data to all 1s. Check these possibilities first. If the voltage measured is 0 V, it may indicate that the transducer has short circuited. The current sources work over the normal absolute input voltage range specifications when the analog inputs are buffered and chop is disabled.

AC EXCITATION

AC excitation of the bridge addresses many of the concerns with thermocouple, offset, and drift effects encountered in dc excited applications. In ac excitation, the polarity of the excitation voltage to the bridge is reversed on alternate cycles. The result is the elimination of dc errors at the expense of a more complex system design. Figure 50 outlines the connections for an ac excited bridge application based on the AD7195.

The excitation voltage to the bridge must be switched on alternate cycles. Transistor T1 to Transistor T4 in Figure 50 perform the switching of the excitation voltage. These transistors can be discrete matched bipolar or MOS transistors, or a dedicated bridge driver chip, such as the MIC4427 available from Micrel Components, can be used to perform the task.

Since the analog input voltage and the reference voltage are reversed on alternate cycles, the AD7195 must be synchronized with this reversing of the excitation voltage. To allow the AD7195 to synchronize itself with this switching, it provides the logic control signals for the switching of the excitation voltage. These signals are the nonoverlapping CMOS outputs ACX1/ACX1 and ACX2/ACX2.

One of the problems encountered with ac excitation is the settling time associated with the analog input signals after the excitation voltage is switched. This is particularly true in applications where there are long lead lengths from the bridge to the AD7195. It means that the converter could encounter errors because it is processing signals that are not fully settled. The AD7195 includes a delay between the switching of the ac excitation signals and the processing of data at the analog inputs. The delay equals 100 μ s when FS[9:0] equals 1 and equals 200 μ s for all other output data rates.

The AD7195 also scales the ac excitation switching frequency in accordance with the output data rate. This avoids situations where the bridge is switched at an unnecessarily faster rate than the system requires.

The fact that the AD7195 can handle reference voltages, which are the same as the excitation voltages, is particularly useful

in ac excitation where resistor divider arrangements on the reference input add to the settling time associated with the switching.

When the ACX bit in the configuration register is set to 0, the digital outputs ACX1 and ACX2 are high, while outputs ACX2 and $\overline{\text{ACX1}}$ are low. Therefore, the bridge is dc excited with the T2 and T4 transistors turned on and the T1 and T3 transistors turned off. When the AD7195 is in power-down mode, outputs ACX1 and ACX2 are low and outputs $\overline{\text{ACX1}}$ and $\overline{\text{ACX2}}$ are high so that the excitation voltage is disconnected from the bridge.

CHANNEL SEQUENCER

The AD7195 includes a channel sequencer, which simplifies communications with the device in multichannel applications. The sequencer also optimizes the channel throughput of the device because the sequencer switches channels at the optimum rate rather than waiting for instructions via the SPI interface.

Bit CH0 to Bit CH7 in the configuration register are used to enable the required channels. In continuous conversion mode, the ADC selects each of the enabled channels in sequence and performs a conversion on the channel. The $\overline{\text{RDY}}$ pin goes low when a valid conversion is available on each channel. When several channels are enabled, the contents of the status register should be attached to the 24-bit word so that the user can identify the channel that corresponds to each conversion. To attach the status register value to the conversion, Bit DAT_STA in the mode register should be set to 1.

Digital Interface

As indicated in the On-Chip Registers section, the programmable functions of the AD7195 are controlled using a set of on-chip registers. Data is written to these registers via the serial interface of the part. Read access to the on-chip registers is also provided by this interface. All communication with the part must start with a write to the communications register. After power-on or reset, the device expects a write to its communications register.

The data written to this register determines whether the next operation is a read operation or a write operation and determines to which register this read or write operation occurs. Therefore, write access to any of the other registers on the part begins with a write operation to the communications register, followed by a write to the selected register. A read operation from any other register (except when continuous read mode is selected) starts with a write to the communications register, followed by a read operation from the selected register.

The serial interface of the AD7195 consists of four signals: $\overline{\text{CS}}$, DIN, SCLK, and DOUT/ $\overline{\text{RDY}}$. The DIN line is used to transfer data into the on-chip registers and DOUT/ $\overline{\text{RDY}}$ is used for accessing data from the on-chip registers. SCLK is the serial clock input for the device, and all data transfers (either on DIN or DOUT/ $\overline{\text{RDY}}$) occur with respect to the SCLK signal.

When several channels are enabled, the ADC must allow the complete settling time to generate a valid conversion each time that the channel is changed. The AD7195 takes care of this: when a channel is selected, the modulator and filter are reset, and the $\overline{\text{RDY}}$ pin is taken high. The AD7195 then allows the complete settling time to generate the first conversion. $\overline{\text{RDY}}$ goes low only when a valid conversion is available. The AD7195 then selects the next enabled channel and converts on that channel. The user can then read the data register while the ADC is performing the conversion on the next channel.

The time required to read a valid conversion from all enabled channels is equal to

$$t_{\text{SETTLE}} \times \text{number of enabled channels}$$

For example, if the sinc⁴ filter is selected, chop is disabled, and zero latency is disabled, the settling time for each channel is equal to

$$t_{\text{SETTLE}} = 4/f_{\text{ADC}}$$

where f_{ADC} is the output data rate when continuously converting on a single channel. The time required to sample N channels is

$$4/(f_{\text{ADC}} \times N)$$

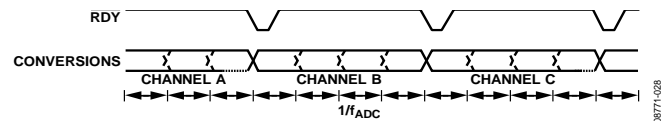

Figure 20. Channel Sequencer

The DOUT/ $\overline{\text{RDY}}$ pin functions as a data ready signal also; the line goes low when a new data-word is available in the output register. It is reset high when a read operation from the data register is complete. It also goes high prior to the updating of the data register to indicate when not to read from the device to ensure that a data read is not attempted while the register is being updated. $\overline{\text{CS}}$ is used to select a device. It can be used to decode the AD7195 in systems where several components are connected to the serial bus.

Figure 3 and Figure 4 show timing diagrams for interfacing to the AD7195, with $\overline{\text{CS}}$ being used to decode the part. Figure 3 shows the timing for a read operation from the output shift register of the AD7195, and Figure 4 shows the timing for a write operation to the input shift register.

It is possible to read the same word from the data register several times even though the DOUT/ $\overline{\text{RDY}}$ line returns high after the first read operation. However, care must be taken to ensure that the read operations are completed before the next output update occurs. In continuous read mode, the data register can be read only once.

The serial interface can operate in 3-wire mode by tying \overline{CS} low. In this case, the SCLK, DIN, and DOUT/RDY lines are used to communicate with the AD7195. The end of the conversion can be monitored using the RDY bit or pin. This scheme is suitable for interfacing to microcontrollers. If \overline{CS} is required as a decoding signal, it can be generated from a port pin. For microcontroller interfaces, it is recommended that SCLK idle high between data transfers.

The AD7195 can be operated with \overline{CS} used as a frame synchronization signal. This scheme is useful for DSP interfaces. In this case, the first bit (MSB) is effectively clocked out by \overline{CS} because \overline{CS} normally occurs after the falling edge of SCLK in DSPs. The SCLK can continue to run between data transfers, provided the timing numbers are obeyed.

The serial interface can be reset by writing a series of 1s to the DIN input. If a Logic 1 is written to the AD7195 DIN line for at least 40 serial clock cycles, the serial interface is reset. This ensures that the interface can be reset to a known state if the interface gets lost due to a software error or some glitch in the system. Reset returns the interface to the state in which it expects a write to the communications register. This operation resets the contents of all registers to their power-on values. Following a reset, the user should allow a period of 500 μ s before addressing the serial interface.

The AD7195 can be configured to continuously convert or to perform a single conversion (see Figure 21 through Figure 23).

Single Conversion Mode

In single conversion mode, the AD7195 is placed in power-down mode after conversions. When a single conversion is initiated by setting MD2, MD1, and MD0 to 0, 0, 1, respectively, in the mode register, the AD7195 powers up, performs a single conversion, and then returns to power-down mode. The on-chip oscillator requires 1 ms, approximately, to power up.

DOUT/RDY goes low to indicate the completion of a conversion. When the data-word has been read from the data register, DOUT/RDY goes high. If \overline{CS} is low, DOUT/RDY remains high until another conversion is initiated and completed. The data register can be read several times, if required, even when DOUT/RDY has gone high.

If several channels are enabled, the ADC sequences through the enabled channels and performs a conversion on each channel. When a conversion is started, DOUT/RDY goes high and remains high until a valid conversion is available. As soon as the conversion is available, DOUT/RDY goes low. The ADC then selects the next channel and begins a conversion. The user can read the present conversion while the next conversion is being performed. As soon as the next conversion is complete, the data register is updated; therefore, the user has a limited period in which to read the conversion. When the ADC has performed a single conversion on each of the selected channels, it returns to power-down mode.

If the DAT_STA bit in the mode register is set to 1, the contents of the status register are output along with the conversion each time that the data read is performed. The four LSBs of the status register indicate the channel to which the conversion corresponds.

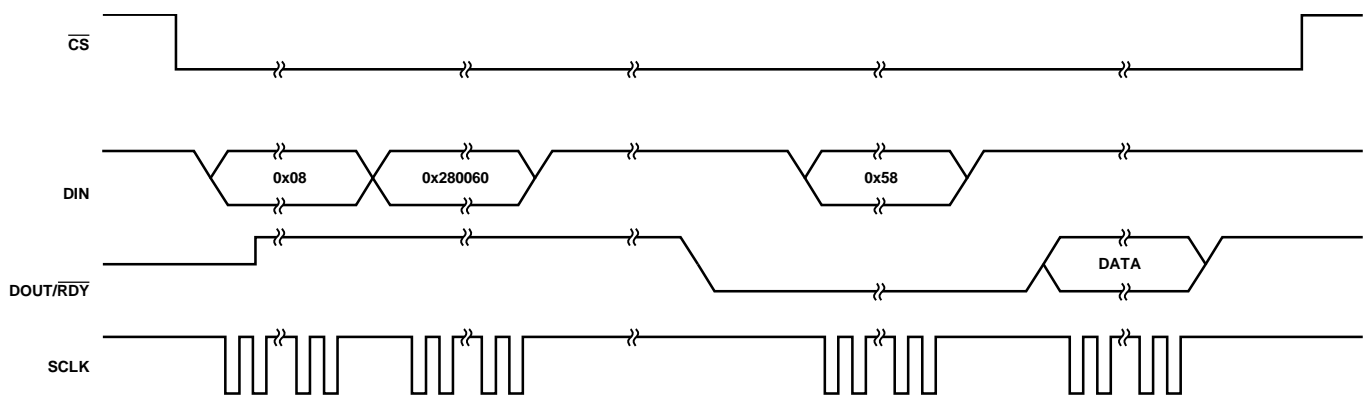

Figure 21. Single Conversion

08771-029

Continuous Conversion Mode

Continuous conversion is the default power-up mode. The AD7195 converts continuously, and the RDY bit in the status register goes low each time a conversion is complete. If CS is low, the DOUT/RDY line also goes low when a conversion is completed. To read a conversion, the user writes to the communications register, indicating that the next operation is a read of the data register. When the data-word has been read from the data register, DOUT/RDY goes high. The user can read this register additional times, if required. However, the user must ensure that the data register is not being accessed at the completion of the next conversion or else the new conversion word is lost.

When several channels are enabled, the ADC continuously loops through the enabled channels, performing one conversion on each channel per loop. The data register is updated as soon as each conversion is available. The DOUT/RDY pin pulses low each time a conversion is available. The user can then read the conversion while the ADC converts on the next enabled channel.

If the DAT_STA bit in the mode register is set to 1, the contents of the status register are output along with the conversion each time that the data read is performed. The status register indicates the channel to which the conversion corresponds.

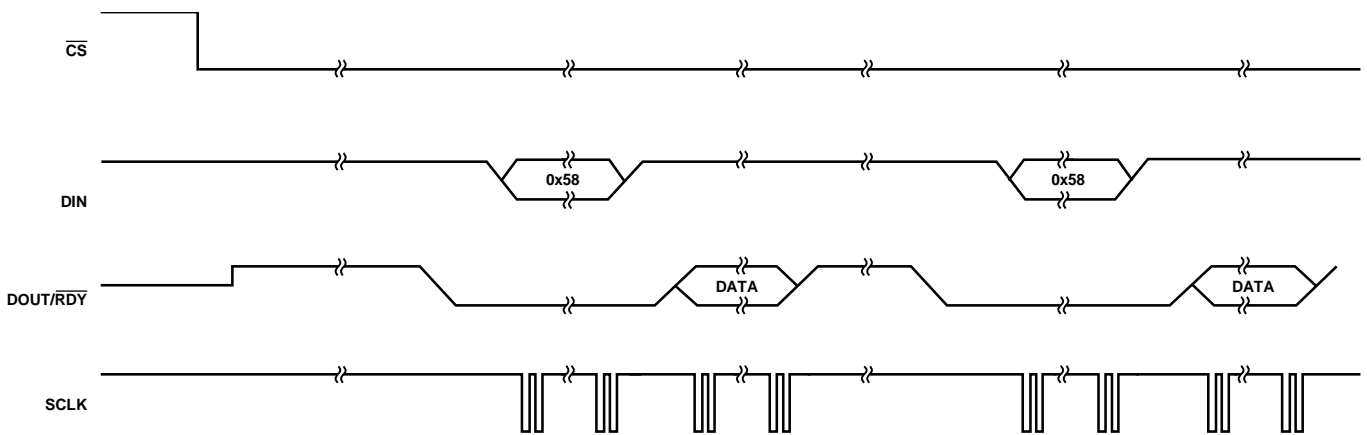

Figure 22. Continuous Conversion

08771-030

Continuous Read

Rather than write to the communications register each time a conversion is complete to access the data, the AD7195 can be configured so that the conversions are placed on the DOUT/RDY line automatically. By writing 01011100 to the communications register, the user need only apply the appropriate number of SCLK cycles to the ADC, and the conversion word is automatically placed on the DOUT/RDY line when a conversion is complete. The ADC should be configured for continuous conversion mode.

When DOUT/RDY goes low to indicate the end of a conversion, sufficient SCLK cycles must be applied to the ADC; the data conversion is then placed on the DOUT/RDY line. When the conversion is read, DOUT/RDY returns high until the next conversion is available. In this mode, the data can be read only once. Also, the user must ensure that the data-word is read before the next conversion is complete. If the user has not read the conversion before the completion of the next conversion, or if insufficient serial clocks are applied to the AD7195 to read the word, the serial output register is reset when the next

conversion is complete, and the new conversion is placed in the output serial register.

To exit the continuous read mode, Instruction 01011000 must be written to the communications register while the RDY pin is low. While in continuous read mode, the ADC monitors activity on the DIN line so that it can receive the instruction to exit the continuous read mode. Additionally, a reset occurs if 40 consecutive 1s are seen on DIN. Therefore, DIN should be held low in continuous read mode until an instruction is to be written to the device.

When several channels are enabled, the ADC continuously steps through the enabled channels and performs one conversion on each channel each time that it is selected. DOUT/RDY pulses low when a conversion is available. When the user applies sufficient SCLK pulses, the data is automatically placed on the DOUT/RDY pin. If the DAT_STA bit in the mode register is set to 1, the contents of the status register are output along with the conversion. The status register indicates the channel to which the conversion corresponds.

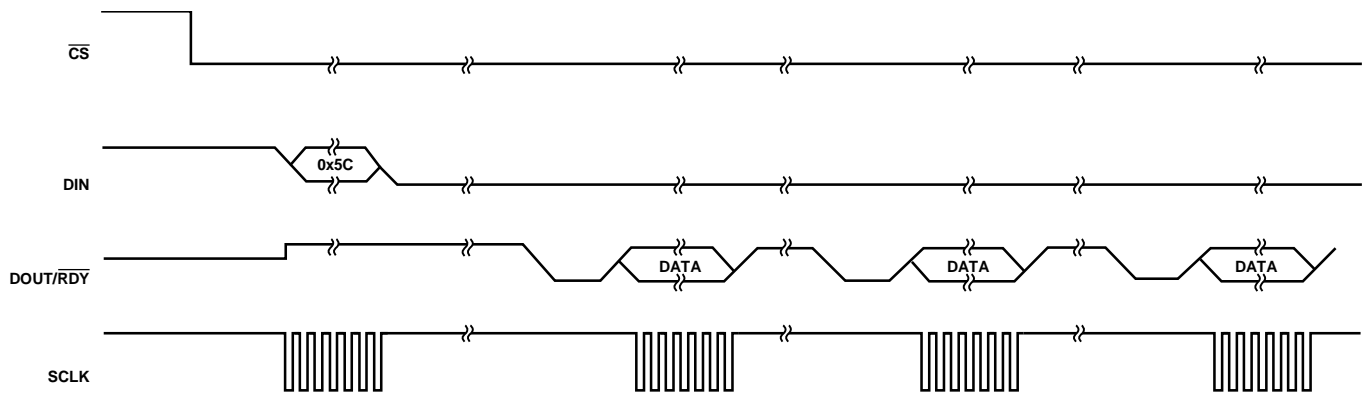

Figure 23. Continuous Read

08771-001

RESET

The circuitry and serial interface of the AD7195 can be reset by writing consecutive 1s to the device; 40 consecutive 1s are required to perform the reset. This resets the logic, the digital filter, and the analog modulator, whereas all on-chip registers are reset to their default values. A reset is automatically performed on power-up. When a reset is initiated, the user must allow a period of 500 μ s before accessing any of the on-chip registers. A reset is useful if the serial interface loses synchronization due to noise on the SCLK line.

SYSTEM SYNCHRONIZATION

The $\overline{\text{SYNC}}$ input allows the user to reset the modulator and the digital filter without affecting any of the setup conditions on the part. This allows the user to start gathering samples of the analog input from a known point in time, that is, the rising edge of $\overline{\text{SYNC}}$. $\overline{\text{SYNC}}$ needs to be taken low for at least four master clock cycles to implement the synchronization function.

If multiple AD7195 devices operate from a common master clock, they can be synchronized so that their data registers are updated simultaneously. A falling edge on the $\overline{\text{SYNC}}$ pin resets the digital filter and the analog modulator and places the AD7195 into a consistent, known state. While the $\overline{\text{SYNC}}$ pin is low, the AD7195 is maintained in this state. On the $\overline{\text{SYNC}}$ rising edge, the modulator and filter are taken out of this reset state and, on the next clock edge, the part starts to gather input samples again. In a system using multiple AD7195 devices, a common signal to their $\overline{\text{SYNC}}$ pins synchronizes their operation. This is normally done after each AD7195 has performed its own calibration or has calibration coefficients loaded into its calibration registers. The conversions from the AD7195s are then synchronized.

The part is taken out of reset on the master clock falling edge following the $\overline{\text{SYNC}}$ low to high transition. Therefore, when multiple devices are being synchronized, the $\overline{\text{SYNC}}$ pin should be taken high on the master clock rising edge to ensure that all devices begin sampling on the master clock falling edge. If the $\overline{\text{SYNC}}$ pin is not taken high in sufficient time, a difference of one master clock cycle may result between the devices; that is, the instant at which conversions are available differs from part to part by a maximum of one master clock cycle.

The $\overline{\text{SYNC}}$ pin can also be used as a start conversion command. In this mode, the rising edge of $\overline{\text{SYNC}}$ starts conversion, and the falling edge of $\overline{\text{RDY}}$ indicates when the conversion is complete. The settling time of the filter has to be allowed for each data register update. For example, if the ADC is configured to use the sinc⁴ filter, zero latency is disabled, and chop is disabled, the settling time equals $4/f_{\text{ADC}}$ where f_{ADC} is the output data rate when continuously converting on a single channel.

CLOCK

The AD7195 includes an internal 4.92 MHz clock on-chip. This internal clock has a tolerance of $\pm 4\%$. Either the internal clock or an external crystal/clock can be used as the clock source to

the AD7195. The clock source is selected using the CLK1 and CLK0 bits in the mode register. When an external crystal is used, it must be connected across the MCLK1 and MCLK2 pins. The crystal manufacturer recommends the load capacitances required for the crystal. The MCLK1 and MCLK2 pins of the AD7195 have a capacitance of 15 pF, typically. If an external clock source is used, the clock source must be connected to the MCLK2 pin, and the MCLK1 pin can be left floating.

The internal clock can also be made available at the MCLK2 pin. This is useful when several ADCs are used in an application and the devices must be synchronized. The internal clock from one device can be used as the clock source for all ADCs in the system. Using a common clock, the devices can be synchronized by applying a common reset to all devices, or the $\overline{\text{SYNC}}$ pin can be pulsed.

ENABLE PARITY

The AD7195 also has an on-chip parity check function that detects 1-bit errors in the serial communications between the ADC and the microprocessor. When the ENPAR bit in the mode register is set to 1, parity is enabled. The contents of the status register must be transmitted along with each 24-bit conversion when the parity function is enabled. To append the contents of the status register to each conversion read, the DAT_STA bit in the mode register should be set to 1.

For each conversion read, the parity bit in the status register is programmed so that the overall number of 1s transmitted in the 24-bit data-word is even. Therefore, for example, if the 24-bit conversion contains eleven 1s (binary format), the parity bit is set to 1 so that the total number of 1s in the serial transmission is even. If the microprocessor receives an odd number of 1s, it knows that the data received has been corrupted.

The parity function only detects 1-bit errors. For example, two bits of corrupt data can result in the microprocessor receiving an even number of 1s. Therefore, an error condition is not detected.

TEMPERATURE SENSOR

Embedded in the AD7195 is a temperature sensor. This is selected using the CH2 bit in the configuration register. When the CH2 bit is set to 1, the temperature sensor is enabled. When the temperature sensor is selected and bipolar mode is selected, the device should return a code of 0x800000 when the temperature is 0 K. A one-point calibration is needed to get the optimum performance from the sensor. Therefore, a conversion at 25°C should be recorded and the sensitivity calculated. The sensitivity is approximately 2815 codes/°C. The equation for the temperature sensor is

$$\text{Temp (K)} = (\text{Conversion} - 0x800000)/2815 \text{ K}$$

$$\text{Temp (}^\circ\text{C)} = \text{Temp (K)} - 273$$

Following the one point calibration, the internal temperature sensor has an accuracy of ± 2 °C, typically.

BRIDGE POWER-DOWN SWITCH

In bridge applications, such as strain gauges and load cells, the bridge itself consumes the majority of the current in the system. For example, a 350 Ω load cell requires 15 mA of current when excited with a 5 V supply. To minimize the current consumption of the system, the bridge can be disconnected (when it is not being used) using the bridge power-down switch. Figure 50 shows how the bridge power-down switch is used. The switch can withstand 30 mA of continuous current, and it has an on resistance of 10 Ω maximum.

CALIBRATION

The AD7195 provides four calibration modes that can be programmed via the mode bits in the mode register. These modes are internal zero-scale calibration, internal full-scale calibration, system zero-scale calibration, and system full-scale calibration. A calibration can be performed at any time by setting the MD2 to MD0 bits in the mode register appropriately. A calibration should be performed when the gain is changed. After each conversion, the ADC conversion result is scaled using the ADC calibration registers before being written to the data register. The offset calibration coefficient is subtracted from the result prior to multiplication by the full-scale coefficient.

To start a calibration, write the relevant value to the MD2 to MD0 bits. The DOUT/RDY pin and the RDY bit in the status register go high when the calibration is initiated. When the calibration is complete, the contents of the corresponding calibration registers are updated, the RDY bit in the status register is reset, the DOUT/RDY pin returns low (if CS is low), and the AD7195 reverts to idle mode.

During an internal zero-scale or full-scale calibration, the respective zero input and full-scale input are automatically connected internally to the ADC input pins. A system calibration, however, expects the system zero-scale and system full-scale voltages to be applied to the ADC pins before initiating the calibration mode. In this way, errors external to the ADC are removed.

From an operational point of view, treat a calibration like another ADC conversion. A zero-scale calibration, if required, must always be performed before a full-scale calibration. Set the system software to monitor the RDY bit in the status register or the DOUT/RDY pin to determine the end of calibration via a polling sequence or an interrupt-driven routine.

With chop disabled, both an internal zero-scale calibration and a system zero-scale calibration require a time equal to the settling time, t_{SETTLE} , ($4/f_{ADC}$ for the sinc⁴ filter and $3/f_{ADC}$ for the sinc³ filter).

With chop enabled, an internal zero-scale calibration is not needed because the ADC itself minimizes the offset continuously. However, if an internal zero-scale calibration is performed, the settling time, t_{SETTLE} , ($2/f_{ADC}$) is required to perform the calibration. Similarly, a system zero-scale calibration requires a time of t_{SETTLE} to complete.

To perform an internal full-scale calibration, a full-scale input voltage is automatically connected to the selected analog input for this calibration. For a gain of 1, the time required for an internal full-scale calibration is equal to t_{SETTLE} . For higher gains, the internal full-scale calibration requires a time of $2 \times t_{SETTLE}$. A full-scale calibration is recommended each time the gain of a channel is changed to minimize the full-scale error.

A system full-scale calibration requires a time of t_{SETTLE} . With chop disabled, the zero-scale calibration (internal or system zero-scale) should be performed before the system full-scale calibration is initiated.

An internal zero-scale calibration, system zero-scale calibration and system full-scale calibration can be performed at any output data rate. An internal full-scale calibration can be performed at any output data rate for which the filter word FS[9:0] is divisible by 16, FS[9:0] being the decimal equivalent of the 10-bit word written to Bit FS9 to Bit FS0 in the mode register. Therefore, internal full-scale calibrations can be performed at output data rates such as 10 Hz or 50 Hz when chop is disabled. Using these lower output data rates results in better calibration accuracy.

The offset error is, typically, 100 μ V/gain. If the gain is changed, it is advisable to perform a calibration. A zero-scale calibration (an internal zero-scale calibration or system zero-scale calibration) reduces the offset error to the order of the noise.

The gain error of the AD7195 is factory calibrated at a gain of 1 with a 5 V power supply at ambient temperature. Following this calibration, the gain error is 0.001%, typically, at 5 V. Table 28 shows the typical uncalibrated gain error for the different gain settings. An internal full-scale calibration reduces the gain error to 0.001%, typically, when the gain is equal to 1. For higher gains, the gain error post internal full-scale calibration is 0.0075%, typically. A system full-scale calibration reduces the gain error to the order of the noise.

Table 28. Typical Precalibration Gain Error vs. Gain

Gain	Precalibration Gain Error (%)
8	-0.11
16	-0.20
32	-0.23
64	-0.29
128	-0.39

The AD7195 gives the user access to the on-chip calibration registers, allowing the microprocessor to read the calibration coefficients of the device and also to write its own calibration coefficients from prestored values in the EEPROM. A read of the registers can be performed at any time. However, the ADC must be placed in power-down or idle mode when writing to the registers. The values in the calibration registers are 24-bits wide. The span and offset of the part can also be manipulated using the registers.

DIGITAL FILTER

The AD7195 offers a lot of flexibility in the digital filter. The device has four filter options. The device can be operated with a sinc³ or sinc⁴ filter, chop can be enabled or disabled, and zero latency can be enabled. The option selected affects the output data rate, settling time, and 50 Hz/60 Hz rejection. The following sections describe each filter type, indicating the available output data rates for each filter option. The filter response along with the settling time and 50 Hz/60 Hz rejection is also discussed.

SINC⁴ FILTER (CHOP DISABLED)

When the AD7195 is powered up, the sinc⁴ filter is selected by default and chop is disabled. This filter gives excellent noise performance over the complete range of output data rates. It also gives the best 50 Hz/60 Hz rejection, but it has a long settling time.

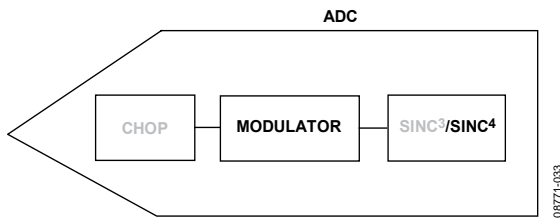

Figure 24. Sinc⁴ Filter (Chop Disabled)

Sinc⁴ Output Data Rate/Settling Time

The output data rate (the rate at which conversions are available on a single channel when the ADC is continuously converting) is equal to

$$f_{ADC} = f_{CLK} / (1024 \times FS[9:0])$$

where:

f_{ADC} is the output data rate.

f_{CLK} is the master clock (4.92 MHz nominal).

$FS[9:0]$ is the decimal equivalent of Bit FS9 to Bit FS0 in the mode register.

The output data rate can be programmed from 4.7 Hz to 4800 Hz; that is, $FS[9:0]$ can have a value from 1 to 1023.

The settling time for the sinc⁴ filter is equal to

$$t_{SETTLE} = 4/f_{ADC}$$

When a channel change occurs, the modulator and filter are reset. The settling time is allowed to generate the first conversion after the channel change. Subsequent conversions on this channel occur at $1/f_{ADC}$.

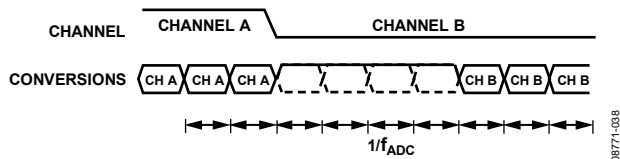

Figure 25. Sinc⁴ Channel Change

When conversions are performed on a single channel and a step change occurs, the ADC does not detect the change in analog input. Therefore, it continues to output conversions at the programmed output data rate. However, it is at least four conversions later before the output data accurately reflect the analog input. If the step change occurs while the ADC is processing a conversion, then the ADC takes five conversions after the step change to generate a fully settled result.

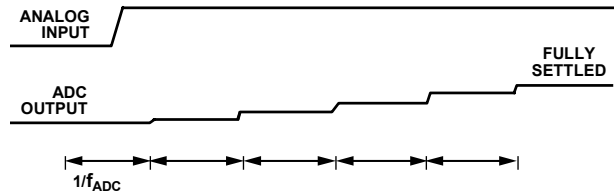

Figure 26. Asynchronous Step Change in Analog Input

The 3 dB frequency for the sinc⁴ filter is equal to

$$f_{3dB} = 0.23 \times f_{ADC}$$

Table 29 gives some examples of the relationship between the values in Bits $FS[9:0]$ and the corresponding output data rate and settling time.

Table 29. Examples of Output Data Rates and the Corresponding Settling Time

FS[9:0]	Output Data Rate (Hz)	Settling Time (ms)
480	10	400
96	50	80
80	60	66.6

Sinc⁴ Zero Latency

Zero latency is enabled by setting the single bit (Bit 11) in the mode register to 1. With zero latency, the complete settling time is allowed for each conversion. Therefore, the conversion time when converting on a single channel or when converting on several channels is constant. The user does not need to consider the effects of channel changes on the output data rate.

The output data rate equals

$$f_{ADC} = 1/t_{SETTLE} = f_{CLK} / (4 \times 1024 \times FS[9:0])$$

where:

f_{ADC} is the output data rate.

f_{CLK} is the master clock (4.92 MHz nominal).

$FS[9:0]$ is the decimal equivalent of Bit FS9 to Bit FS0 in the mode register.

When the analog input is constant or a channel change occurs, valid conversions are available at a constant output data rate. When conversions are being performed on a single channel and a step change occurs on the analog input, the ADC continues to output fully settled conversions if the step change is synchronized with the conversion process. If the step change is asynchronous, one conversion is output from the ADC, which is not completely settled (see Figure 27).

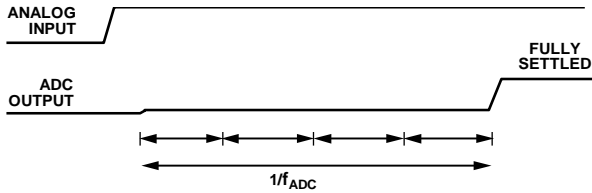

Figure 27. Sinc⁴ Zero Latency Operation

Table 30 shows examples of output data rate and the corresponding FS values.

Table 30. Examples of Output Data Rates and the Corresponding Settling Time (Zero Latency)

FS[9:0]	Output Data Rate (Hz)	Settling Time (ms)
480	2.5	400
96	12.5	80
80	15	66.6

Sinc⁴ 50 Hz/60 Hz Rejection

Figure 28 shows the frequency response of the sinc⁴ filter when FS[9:0] is set to 96 and the master clock is 4.92 MHz. With zero latency disabled, the output data rate is equal to 50 Hz. With zero latency enabled, the output data rate is 12.5 Hz. The sinc⁴ filter provides 50 Hz (±1 Hz) rejection in excess of 120 dB minimum, assuming a stable master clock.

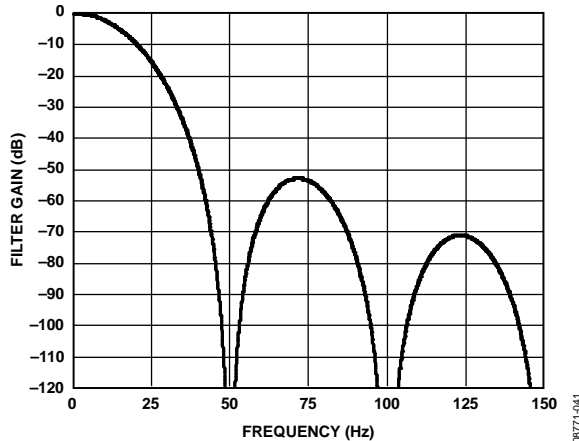

Figure 28. Sinc⁴ Filter Response (FS[9:0] = 96)

Figure 29 shows the frequency response when FS[9:0] is programmed to 80 and the master clock is equal to 4.92 MHz. The output data rate is 60 Hz when zero latency is disabled and 15 Hz when zero latency is enabled. The sinc⁴ filter provides 60 Hz (±1 Hz) rejection of 120 dB minimum, assuming a stable master clock.

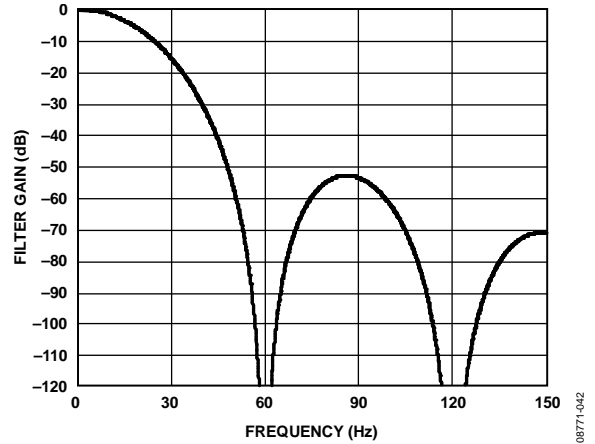

Figure 29. Sinc⁴ Filter Response (FS[9:0] = 80)

Simultaneous 50 Hz and 60 Hz rejection is obtained when FS[9:0] is programmed to 480 and the master clock equals 4.92 MHz. The output data rate is 10 Hz when zero latency is disabled and 2.5 Hz when zero latency is enabled. The sinc⁴ filter provides 50 Hz (±1 Hz) and 60 Hz (±1 Hz) rejection of 120 dB minimum, assuming a stable master clock.

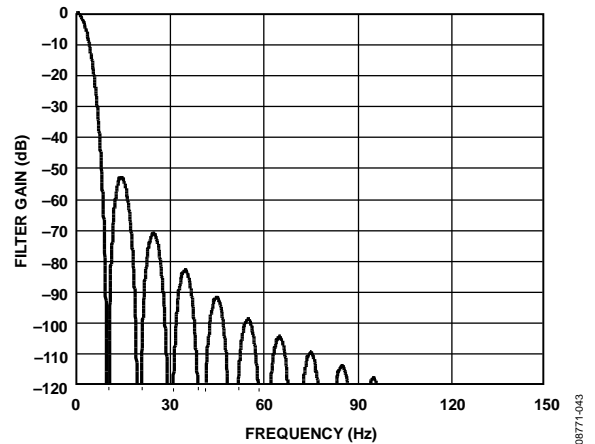

Figure 30. Sinc⁴ Filter Response (FS[9:0] = 480)

Simultaneous 50 Hz/60 Hz rejection can also be achieved using the REJ60 bit in the mode register. When FS[9:0] is set to 96 and REJ60 is set to 1, notches are placed at 50 Hz and 60 Hz.

The output data rate is 50 Hz when zero latency is disabled and 12.5 Hz when zero latency is enabled. Figure 31 shows the frequency response of the sinc⁴ filter. The filter provides 50 Hz ± 1 Hz and 60 Hz ± 1 Hz rejection of 82 dB minimum, assuming a stable 4.92 MHz master clock.

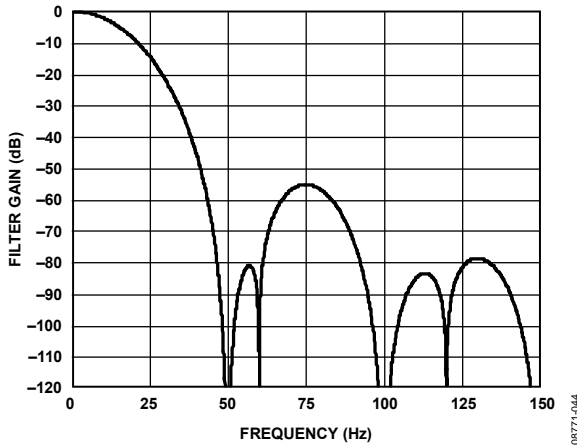

Figure 31. Sinc⁴ Filter Response (FS[9:0] = 96, REJ60 = 1)

SINC³ FILTER (CHOP DISABLED)

A sinc³ filter can be used instead of the sinc⁴ filter. The filter is selected using the SINC3 bit in the mode register. The sinc³ filter is selected when the SINC3 bit is set to 1.

This filter has good noise performance when operating with output data rates up to 1 kHz. It has moderate settling time and moderate 50 Hz/60 Hz (±1 Hz) rejection.

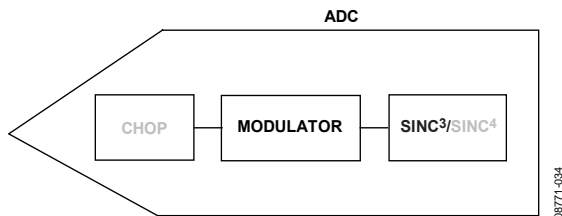

Figure 32. Sinc³ Filter (Chop Disabled)

Sinc³ Output Data Rate and Settling Time

The output data rate (the rate at which conversions are available on a single channel when the ADC is continuously converting) is equal to

$$f_{ADC} = f_{CLK} / (1024 \times FS[9:0])$$

where:

f_{ADC} is the output data rate.

f_{CLK} is the master clock (4.92 MHz nominal).

FS[9:0] is the decimal equivalent of Bit FS9 to Bit FS0 in the mode register.

The output data rate can be programmed from 4.7 Hz to 4800 Hz; that is, FS[9:0] can have a value from 1 to 1023.

The settling time is equal to

$$t_{SETTLE} = 3/f_{ADC}$$

The 3 dB frequency is equal to

$$f_{3dB} = 0.272 \times f_{ADC}$$

Table 31 gives some examples of FS settings and the corresponding output data rates and settling times.

Table 31. Examples of Output Data Rates and the Corresponding Settling Time

FS[9:0]	Output Data Rate (Hz)	Settling Time (ms)
480	10	300
96	50	60
80	60	50

When a channel change occurs, the modulator and filter reset. The complete settling time is allowed to generate the first conversion after the channel change (see Figure 33). Subsequent conversions on this channel are available at 1/f_{ADC}.

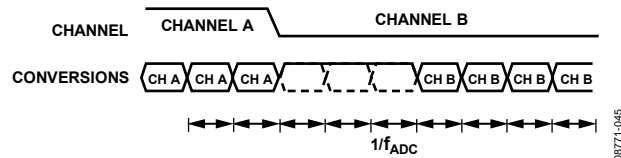

Figure 33. Sinc³ Channel Change

When conversions are performed on a single channel and a step change occurs, the ADC does not detect the change in analog input. Therefore, it continues to output conversions at the programmed output data rate. However, it is at least three conversions later before the output data accurately reflects the analog input. If the step change occurs while the ADC is processing a conversion, the ADC takes four conversions after the step change to generate a fully settled result.

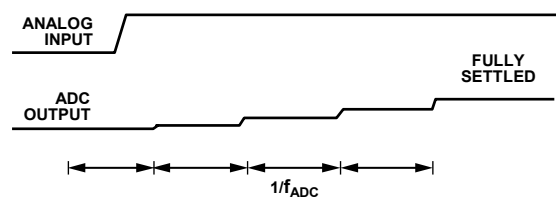

Figure 34. Asynchronous Step Change in Analog Input

Sinc³ Zero Latency

Zero latency is enabled by setting the single bit (Bit 11) in the mode register to 1. With zero latency, the complete settling time is allowed for each conversion. Therefore, the conversion time when converting on a single channel or when converting on several channels is constant. The user does not need to consider the effects of channel changes on the output data rate.

The output data rate equals

$$f_{ADC} = 1/t_{SETTLE} = f_{CLK}/(3 \times 1024 \times FS[9:0])$$

where:

f_{ADC} is the output data rate.

f_{CLK} is the master clock (4.92 MHz nominal).

$FS[9:0]$ is the decimal equivalent of Bit FS9 to Bit FS0 in the mode register.

When the analog input is constant or a channel change occurs, valid conversions are available at a constant output data rate. When conversions are being performed on a single channel and a step change occurs on the analog input, the ADC continues to output fully settled conversions if the step change is synchronized with the conversion process. If the step change is asynchronous, one conversion is output from the ADC that is not completely settled (see Figure 35).

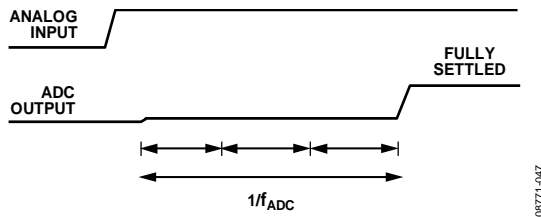

Figure 35. Sinc³ Zero Latency Operation

Table 32 provides examples of output data rates and the corresponding FS values.

Table 32. Examples of Output Data Rates and the Corresponding Settling Time (Zero Latency)

FS[9:0]	Output Data Rate (Hz)	Settling Time (ms)
480	3.3	300
96	16.7	60
80	20	50

Sinc³ 50 Hz/60 Hz Rejection

Figure 36 show the frequency response of the sinc³ filter when FS[9:0] is set to 96 and the master clock equals 4.92 MHz. The output data rate is equal to 50 Hz when zero latency is disabled and 16.7 Hz when zero latency is enabled. The sinc³ filter gives 50 Hz \pm 1 Hz rejection of 95 dB minimum for a stable master clock.

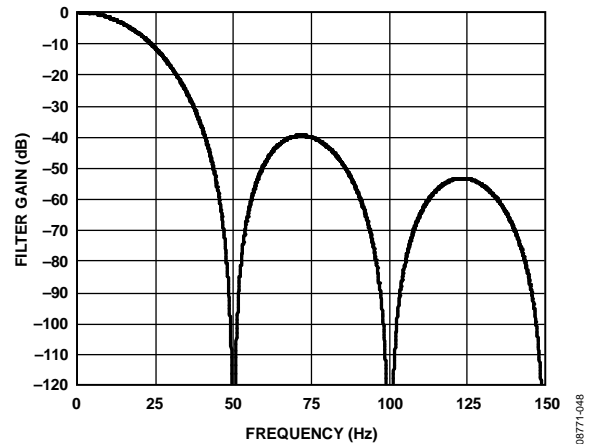

Figure 36. Sinc³ Filter Response (FS[9:0] = 96)

When FS[9:0] is set to 80 and the master clock equals 4.92 MHz, 60 Hz rejection is achieved (see Figure 37). The output data rate is equal to 60 Hz when zero latency is disabled and 20 Hz when zero latency is enabled. The sinc³ filter has rejection of 95 dB minimum at 60 Hz \pm 1 Hz, assuming a stable master clock.

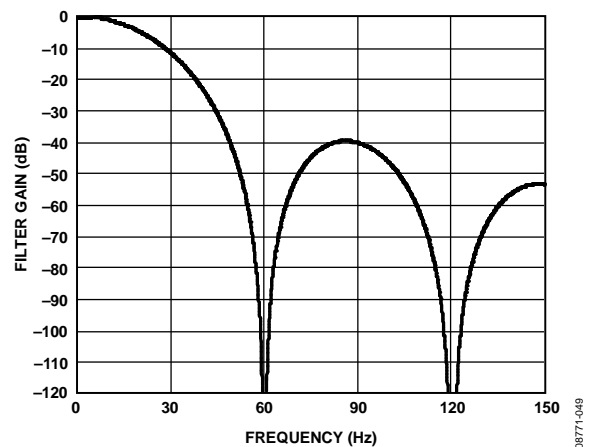

Figure 37. Sinc³ Filter Response (FS[9:0] = 80)

Simultaneous 50 Hz and 60 Hz rejection is obtained when FS[9:0] is set to 480 (master clock = 4.92 MHz), as shown in Figure 38. The output data rate is 10 Hz when zero latency is disabled and 3.3 Hz when zero latency is enabled. The sinc³ filter has rejection of 100 dB minimum at 50 Hz ± 1 Hz and 60 Hz ± 1 Hz.

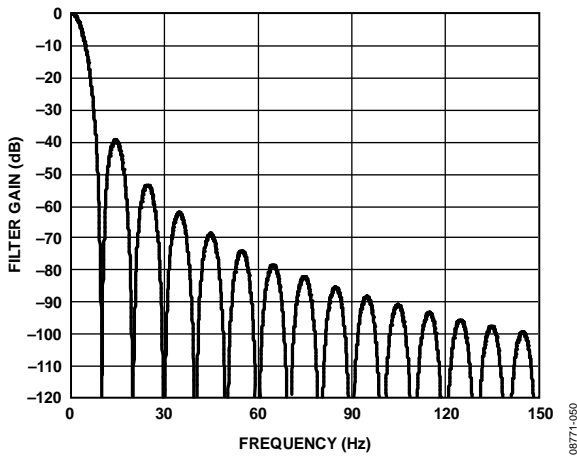

Figure 38. Sinc³ Filter Response (FS[9:0] = 480)

Simultaneous 50 Hz/60 Hz rejection is also achieved using the REJ60 bit in the mode register. When FS[9:0] is programmed to 96 and the REJ60 bit is set to 1, notches are placed at both 50 Hz and 60 Hz for a stable 4.92 MHz master clock. Figure 39 shows the frequency response of the sinc³ filter with this configuration. Assuming a stable clock, the rejection at 50 Hz/60 Hz (±1 Hz) is in excess of 67 dB minimum.

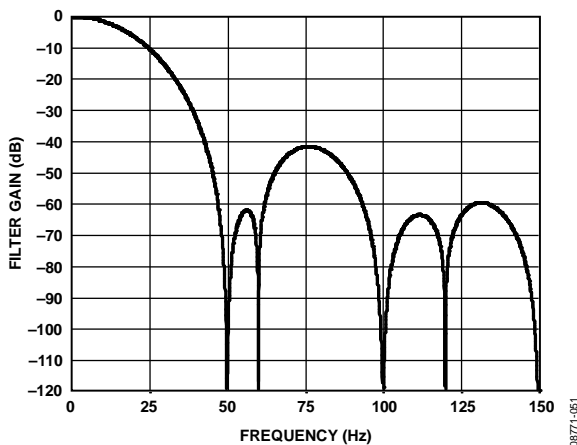

Figure 39. Sinc³ Filter Response (FS[9:0] = 96, REJ60 = 1)

CHOP ENABLED (SINC⁴ FILTER)

With chop enabled, the ADC offset and offset drift are minimized. The analog input pins are continuously swapped. With the analog input pins connected in one direction, the settling time of the sinc filter is allowed and a conversion is recorded. The analog input pins are then inverted, and another settled conversion is obtained. Subsequent conversions are averaged to minimize the offset. This continuous swapping of the analog input pins and the averaging of subsequent conversions means that the offset drift is also minimized. With chop enabled, the resolution increases by 0.5 bits.

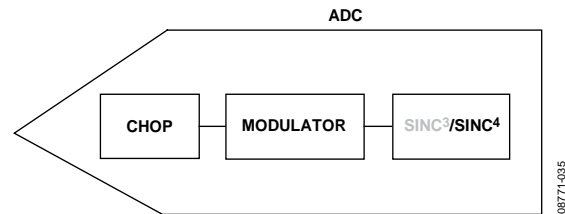

Figure 40. Chop Enabled

Output Data Rate and Settling Time (Sinc⁴ Chop Enabled)

For the sinc⁴ filter, the output data rate is equal to

$$f_{ADC} = f_{CLK} / (4 \times 1024 \times FS[9:0])$$

where:

f_{ADC} is the output data rate.

f_{CLK} is the master clock (4.92 MHz nominal).

FS[9:0] is the decimal equivalent of Bit FS9 to Bit FS0 in the mode register.

The value of FS[9:0] can be varied from 1 to 1023. This results in an output data rate of 1.17 Hz to 1200 Hz. The settling time is equal to

$$t_{SETTLE} = 2 / f_{ADC}$$

Table 33 gives some examples of FS[9:0] values and the corresponding output data rates and settling times.

Table 33. Examples of Output Data Rates and the Corresponding Settling Time

FS[9:0]	Output Data Rate (Hz)	Settling Time (ms)
96	12.5	160
80	15	133

When a channel change occurs, the modulator and filter reset. The complete settling time is required to generate the first conversion after the channel change. Subsequent conversions on this channel occur at $1/f_{ADC}$.

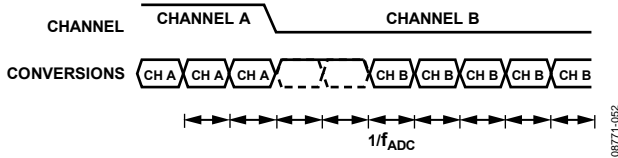

Figure 41. Channel Change ($Sinc^4$ Chop Enabled)

When conversions are performed on a single channel and a step change occurs, the ADC does not detect the change in analog input; therefore, it continues to output conversions at the programmed output data rate. However, it is at least two conversions later before the output data accurately reflects the analog input. If the step change occurs while the ADC is processing a conversion, the ADC takes three conversions after the step change to generate a fully settled result.

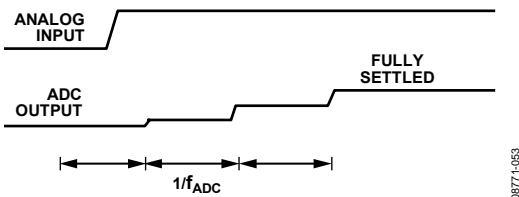

Figure 42. Asynchronous Step Change in Analog Input ($Sinc^4$ Chop Enabled)

The cutoff frequency f_{3dB} is equal to

$$f_{3dB} = 0.24 \times f_{ADC}$$

50 Hz/60 Hz Rejection ($Sinc^4$ Chop Enabled)

When FS[9:0] is set to 96 and chopping is enabled, the output data rate is equal to 12.5 Hz for a 4.92 MHz master clock. The filter response shown in Figure 43 is obtained. The chopping introduces notches at odd integer multiples of $f_{ADC}/2$. The notches due to the sinc filter in addition to the notches introduced by the chopping mean that simultaneous 50 Hz and 60 Hz rejection is achieved for an output data rate of 12.5 Hz. The rejection at 50 Hz/60 Hz ± 1 Hz is typically 63 dB, assuming a stable master clock.

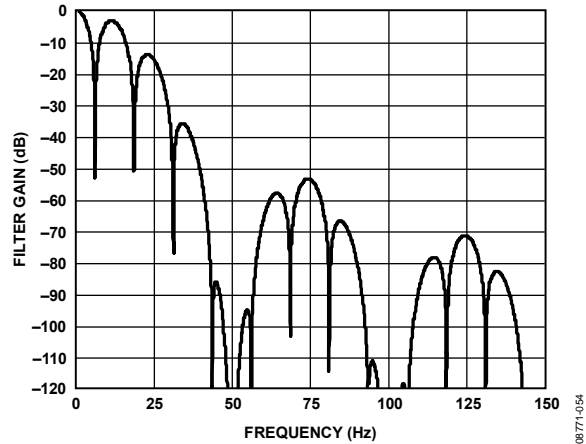

Figure 43. $Sinc^4$ Filter Response ($FS[9:0] = 96$, Chop Enabled)

The 50 Hz/60 Hz rejection can be improved by setting the REJ60 bit in the mode register to 1. With FS[9:0] set to 96 and REJ60 set to 1, the filter response shown Figure 44 is achieved. The output data rate is unchanged but the 50 Hz/60 Hz (± 1 Hz) rejection is increased to 83 dB typically.

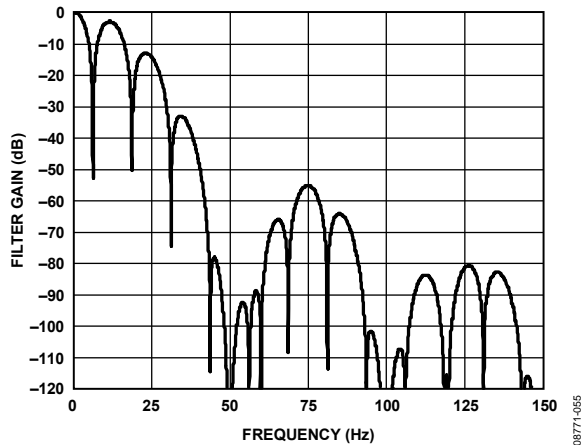

Figure 44. $Sinc^4$ Filter Response ($FS[9:0] = 96$, Chop Enabled, $REJ60 = 1$)

CHOP ENABLED (SINC³ FILTER)

With chop enabled, the ADC offset and offset drift are minimized. The analog input pins are continuously swapped. With the analog input pins connected in one direction, the settling time of the sinc filter is allowed and a conversion is recorded. The analog input pins invert and another settled conversion is obtained. Subsequent conversions are averaged to minimize the offset. This continuous swapping of the analog input pins and the averaging of subsequent conversions means that the offset drift is also minimized. With chop enabled, the resolution increases by 0.5 bits. Using the sinc³ filter with chop enabled is suitable for output data rates up to 320 Hz.

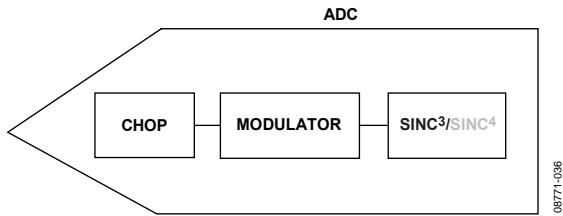

Figure 45. Chop Enabled (Sinc³ Chop Enabled)

Output Data Rate and Settling Time (Sinc³ Chop Enabled)

For the sinc³ filter, the output data rate is equal to

$$f_{ADC} = f_{CLK} / (3 \times 1024 \times FS[9:0])$$

where:

f_{ADC} is the output data rate.

f_{CLK} is the master clock (4.92 MHz nominal).

$FS[9:0]$ is the decimal equivalent of Bit FS9 to Bit FS0 in the mode register.

The value of $FS[9:0]$ can be varied from 1 to 1023. This results in an output data rate of 1.56 Hz to 1600 Hz. The settling time is equal to

$$t_{SETTLE} = 2/f_{ADC}$$

Table 34. Examples of Output Data Rates and the Corresponding Settling Time (Chop Enabled, Sinc³ Filter)

FS[9:0]	Output Data Rate (Hz)	Settling Time (ms)
96	16.7	120
80	20	100

When a channel change occurs, the modulator and filter are reset. The complete settling time is required to generate the first conversion after the channel change. Subsequent conversions on this channel occur at $1/f_{ADC}$.

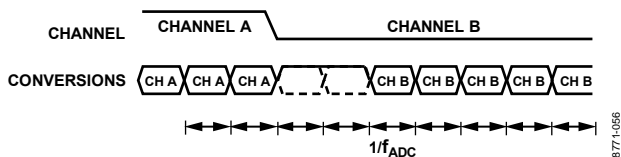

Figure 46. Channel Change (Sinc³ Chop Enable)

If conversions are performed on a single channel and a step change occurs, the ADC does not detect the change in analog input; therefore, it continues to output conversions at the programmed output data rate. However, it is at least two conversions later before the output data accurately reflects the analog input. If the step change occurs while the ADC is processing a conversion, then the ADC takes three conversions after the step change to generate a fully settled result.

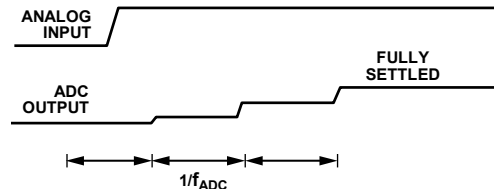

Figure 47. Asynchronous Step Change in Analog Input (Sinc³ Chop Enabled)

The cutoff frequency f_{3dB} is equal to

$$f_{3dB} = 0.24 \times f_{ADC}$$

50 Hz/60 Hz Rejection (Sinc³ Chop Enabled)

When $FS[9:0]$ is set to 96 and chopping is enabled, the filter response shown in Figure 48 is obtained. The output data rate is equal to 16.7 Hz for a 4.92 MHz master clock. The chopping introduces notches at odd integer multiples of $f_{ADC}/2$. The notches due to the sinc filter in addition to the notches introduced by the chopping means that simultaneous 50 Hz and 60 Hz rejection is achieved for an output data rate of 16.7 Hz. The rejection at 50 Hz/60 Hz ± 1 Hz is typically 53 dB, assuming a stable master clock.

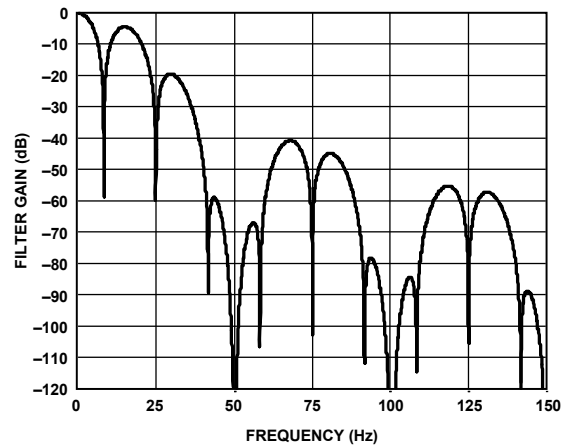

Figure 48. Sinc³ Filter Response ($FS[9:0] = 96$, Chop Enabled)

The 50 Hz/60 Hz rejection can be improved by setting the REJ60 bit in the mode register to 1. With FS[9:0] set to 96 and REJ60 set to 1, the filter response shown in Figure 49 is achieved. The output data rate is unchanged, but the 50 Hz/60 Hz ± 1 Hz rejection improves to 73 dB typically.

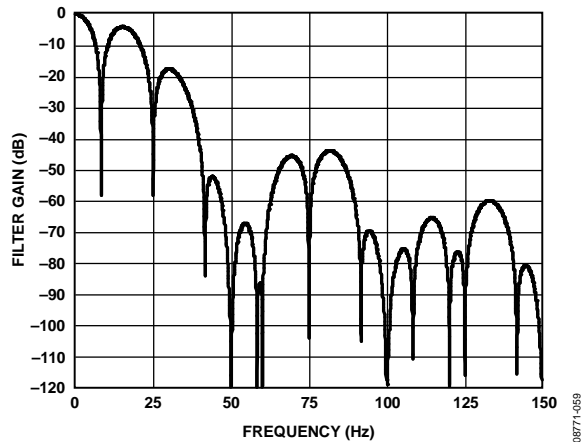

Figure 49. Sinc³ Filter Response
(FS[9:0] = 96, Chop Enabled, REJ60 = 1)

SUMMARY OF FILTER OPTIONS

The AD7195 has several filter options. The filter that is chosen affects the output data rate, settling time, the rms noise, the stop band attenuation, and the 50 Hz/60 Hz rejection.

Table 35 shows some sample configurations and the corresponding performance in terms of throughput, settling time and 50 Hz/60 Hz rejection.

Table 35. Filter Summary¹

Filter	FS[9:0]	Output Data Rate (Hz)	Settling Time (ms)	Throughput ² (Hz)	REJ60	50 Hz Rejection (dB)
Sinc ⁴ , Chop Disabled ³	1	4800	0.83	1200	0	No 50 Hz or 60 Hz rejection
Sinc ⁴ , Chop Disabled	5	960	4.17	240	0	No 50 Hz or 60 Hz rejection
Sinc ³ , Chop Disabled	5	960	3.125	320	0	No 50 Hz or 60 Hz rejection
Sinc ⁴ , Chop Disabled	480	10	400	2.5	0	120 dB (50 Hz and 60 Hz)
Sinc ³ , Chop Disabled	480	10	300	3.33	0	100 dB (50 Hz and 60 Hz)
Sinc ⁴ , Chop Disabled	96	50	80	12.5	0	120 dB (50 Hz only)
Sinc ⁴ , Chop Disabled	96	50	80	12.5	1	82 dB (50 Hz and 60 Hz)
Sinc ³ , Chop Disabled	96	50	60	16.7	0	95 dB (50 Hz only)
Sinc ³ , Chop Disabled	96	50	60	16.7	1	67 dB (50 Hz and 60 Hz)
Sinc ⁴ , Chop Disabled	80	60	66.67	15	0	120 dB (60 Hz only)
Sinc ³ , Chop Disabled	80	60	50	20	0	95 dB (60 Hz only)
Sinc ⁴ , Chop Disabled, Zero Latency	96	12.5	80	12.5	0	120 dB (50 Hz only)
Sinc ⁴ , Chop Disabled, Zero Latency	96	12.5	80	12.5	1	82 dB (50 Hz and 60 Hz)
Sinc ⁴ , Chop Disabled, Zero Latency	80	15	66.67	15	0	120 dB (60 Hz only)
Sinc ⁴ , Chop Enabled	96	12.5	160	6.25	1	80 dB (50 Hz and 60 Hz)
Sinc ³ , Chop Enabled	96	16.7	120	8.33	1	67 dB (50 Hz and 60 Hz)

¹ These calculations assume a 4.92 MHz stable master clock.

² Throughput is the rate at which conversions are available when several channels are enabled. In zero latency mode, the output data rate and throughput are equal.

³ For output data rates greater than 1 kHz, the sinc⁴ filter is recommended.

GROUNDING AND LAYOUT

Because the analog inputs and reference inputs are differential, most of the voltages in the analog modulator are common-mode voltages. The high common-mode rejection of the part removes common-mode noise on these inputs. The analog and digital supplies to the AD7195 are independent and separately pinned out to minimize coupling between the analog and digital sections of the device. The digital filter provides rejection of broadband noise on the power supplies, except at integer multiples of the modulator sampling frequency.

Connect an R-C filter to each analog input pin to provide rejection at the modulator sampling frequency. The digital filter also removes noise from the analog and reference inputs provided these noise sources do not saturate the analog modulator. As a result, the AD7195 is more immune to noise interference than a conventional high resolution converter. However, because the resolution of the AD7195 is so high and the noise levels from the converter so low, care must be taken with regard to grounding and layout.

The printed circuit board (PCB) that houses the ADC must be designed so that the analog and digital sections are separated and confined to certain areas of the board. This facilitates the use of ground planes that can be easily separated. A minimum etch technique is generally best for ground planes because it gives the best shielding.

Although the AD7195 has separate pins for analog and digital ground, the AGND and DGND pins are tied together internally via the substrate. Therefore, the user must not tie these two pins to separate ground planes unless the ground planes are connected together near the AD7195.

In systems where AGND and DGND are connected elsewhere in the system, they should not be connected again at the AD7195 because this would result in a ground loop. In these

situations, it is recommended that the ground pins of the AD7195 be tied to the AGND plane.

In any layout, the user must keep in mind the flow of currents in the system, ensuring that the paths for all currents are as close as possible to the paths the currents took to reach their destinations. Avoid forcing digital currents to flow through the AGND.

Avoid running digital lines under the device because this couples noise onto the die and allow the analog ground plane to run under the AD7195 to prevent noise coupling. The power supply lines to the AD7195 must use as wide a trace as possible to provide low impedance paths and reduce the effects of glitches on the power supply line. Shield fast switching signals like clocks with digital ground to prevent radiating noise to other sections of the board, and never run clock signals near the analog inputs. Avoid crossover of digital and analog signals. Run traces on opposite sides of the board at right angles to each other. This reduces the effects of feedthrough through the board. A microstrip technique is by far the best but is not always possible with a double-sided board. In this technique, the component side of the board is dedicated to ground planes, whereas signals are placed on the solder side.

Good decoupling is important when using high resolution ADCs. Decouple all analog supplies with 10 μF tantalum in parallel with 0.1 μF capacitors to AGND. To achieve the best from these decoupling components, place them as close as possible to the device, ideally right up against the device. Decouple all logic chips with 0.1 μF ceramic capacitors to DGND. In systems in which a common supply voltage is used to drive both the AV_{DD} and DV_{DD} of the AD7195, it is recommended that the system AV_{DD} supply be used. For this supply, place the recommended analog supply decoupling capacitors between the AV_{DD} pin of the AD7195 and AGND and the recommended digital supply decoupling capacitor between the DV_{DD} pin of the AD7195 and DGND.

APPLICATIONS INFORMATION

The AD7195 provides a low-cost, high resolution analog-to-digital function. Because the analog-to-digital function is provided by a Σ - Δ architecture, the part is more immune to noisy environments, making it ideal for use in sensor measurement and industrial and process control applications.

WEIGH SCALES

Figure 50 shows the AD7195 being used in a weigh scale application which uses ac excitation. The load cell is arranged in a bridge network and gives a differential output voltage between its OUT+ and OUT- terminals. Assuming a 5 V excitation voltage, the full-scale output range from the transducer is 10 mV when the sensitivity is 2 mV/V. The excitation voltage for the bridge can be used to directly provide the reference for the ADC because the reference input range includes the supply voltage.

With ac-excitation, the excitation voltage to the load cell is changed on each phase. In Phase 1, the T2 and T4 transistors are turned on using ACX1 and ACX1 while the T1 and T3 transistors are turned off. The bridge is forward biased. During Phase 2, Transistor T1 and Transistor T3 are turned on using

ACX2 and ACX2. In this phase, the excitation voltage to the bridge is reversed while the analog input signal and the reference voltage are also reversed. The AD7195 averages the conversions from the two phases so that any offsets and thermal affects are cancelled.

AC excitation is enabled by setting Bit ACX in the configuration register to 1. When the ACX bit is set to 0, the bridge is dc excited. When the AD7195 is in power-down mode, the bridge is disconnected from the excitation voltage, which minimizes power consumption of the system. Following a reset, the ac excitation pins are undefined for a few milliseconds. Thus, pull-up/pull-down resistors should be used on the pins to prevent the excitation voltage being shorted to AGND.

For simplicity, external filters are not included in Figure 50. However, an R-C antialias filter must be included on each analog input. This is required because the on-chip digital filter does not provide any rejection around the modulator sampling frequency or multiples of this frequency.

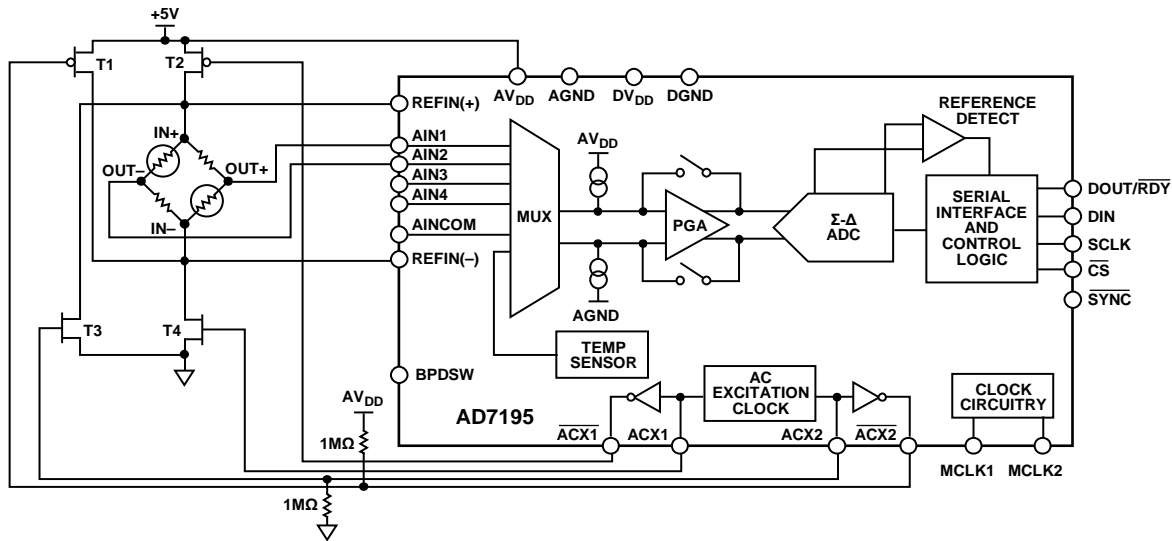
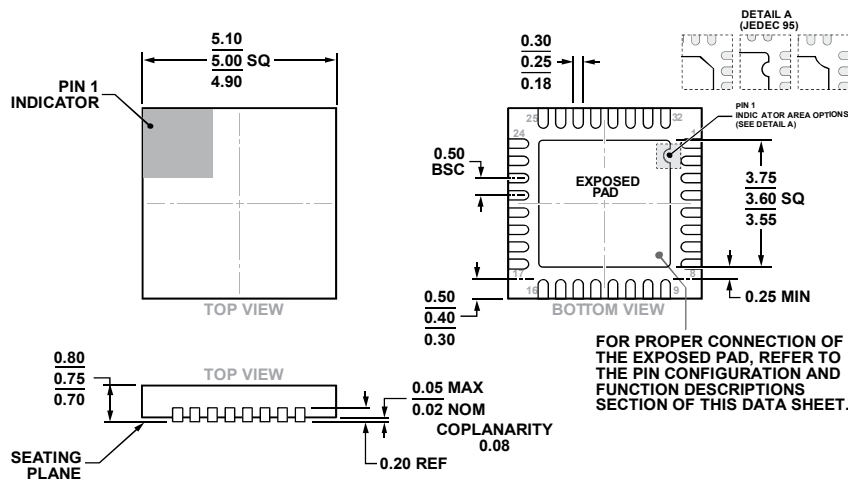

Figure 50. Typical Application (Weigh Scale)

08771-032

OUTLINE DIMENSIONS



COMPLIANT TO JEDEC STANDARDS MO-220-WHHD-5.

Figure 51. 32-Lead Lead Frame Chip Scale Package [LFCSP]
5 mm × 5 mm Body and 0.75 mm Package Height
(CP-32-12)

Dimensions shown in millimeters

ORDERING GUIDE

Model ¹	Temperature Range	Package Description	Package Option
AD7195BCPZ	-40°C to +105°C	32-Lead LFCSP	CP-32-12
AD7195BCPZ-RL	-40°C to +105°C	32-Lead LFCSP	CP-32-12
AD7195BCPZ-RL7	-40°C to +105°C	32-Lead LFCSP	CP-32-12
EVAL-AD7195EBZ		Evaluation Board	

¹ Z = RoHS Compliant Part.