

FEATURES

- 80 MSPS sample rate
- 80 dBFS signal-to-noise ratio
- Transformer-coupled analog input
- Single PECL clock source
- Digital outputs
 - True binary format
 - 3.3 V and 5 V CMOS-compatible

APPLICATIONS

- Low signature radar
- Medical imaging
- Communications instrumentation
- Instrumentation
- Antenna array processing

GENERAL DESCRIPTION

The AD10678 is a 16-bit, high performance, analog-to-digital converter (ADC) for applications that demand increased SNR levels. Exceptional noise performance and a typical signal-to-noise ratio of 80 dBFS are obtained by digitally postprocessing the outputs of four ADCs. A single analog input and PECL sampling clock and 3.3 V and 5 V power supplies are required.

The AD10678 is assembled using a 0.062-inch laminate board with three sets of connector interface pads to accommodate analog and digital isolation. Analog Devices recommends using the FSI-110-03-G-D-AD-K-TR connector from Samtec. The overall board fits a 2.2 inch × 2.8 inch PCB specified from 0°C to 70°C.

FUNCTIONAL BLOCK DIAGRAM

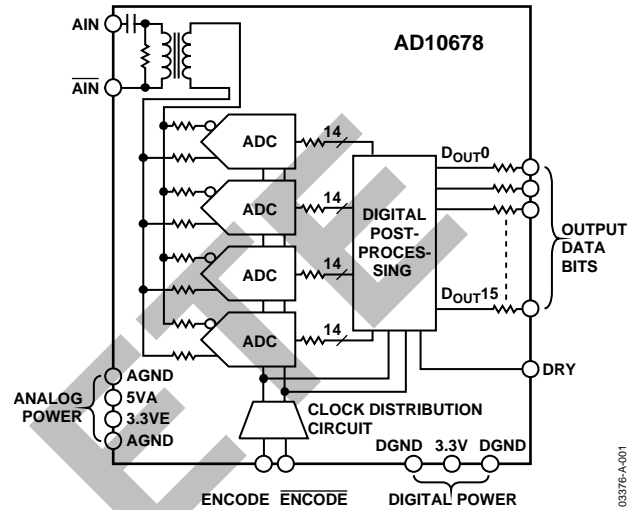

Figure 1.

PRODUCT HIGHLIGHTS

1. Guaranteed sample rate of 80 MSPS.
2. Input signal conditioning with optimized noise performance.
3. Fully tested and guaranteed performance.

Rev. C

Information furnished by Analog Devices is believed to be accurate and reliable. However, no responsibility is assumed by Analog Devices for its use, nor for any infringements of patents or other rights of third parties that may result from its use. Specifications subject to change without notice. No license is granted by implication or otherwise under any patent or patent rights of Analog Devices. Trademarks and registered trademarks are the property of their respective owners.

TABLE OF CONTENTS

Features	1	Test Circuits.....	7
Applications.....	1	Pin Configurations and Function Descriptions.....	8
General Description.....	1	Typical Performance Characteristics	10
Functional Block Diagram	1	Terminology	12
Product Highlights	1	Theory of Operation	13
Table of Contents	2	Thermal Considerations.....	13
Revision History	2	Input Stage.....	13
Specifications.....	3	Encoding the AD10678.....	13
DC Specifications	3	Output Loading	13
Digital Specifications	3	Analog and Digital Power Supplies.....	13
AC Specifications.....	4	Analog and Digital Grounding.....	14
Switching Specifications	5	Other Notes.....	14
Absolute Maximum Ratings.....	6	Evaluation Board.....	14
Explanation of Test Levels.....	6	Outline Dimensions	19
Operating Range.....	6	Ordering Guide	19
ESD Caution.....	6		

REVISION HISTORY

5/06—Rev. B to Rev. C

Changes to Figure 9.....	9
Edits to Table 8.....	15
Edits to Figure 22.....	16

3/05—Rev. A to Rev. B

Changes to Figure 1.....	1
Changes to Figure 2 and Figure 3.....	7
Added Figure 7 to Figure 9.....	8
Reformatted Table 7.....	8
Changes to Figure 10.....	9
Reformatted Theory of Operation Section	13
Changes to Figure 22.....	15

12/03—Rev. 0 to Rev. A

Updated format.....	Universal
Changes to AC Specifications Table Footnotes	4
Changes to Table 1.....	3
Changes to Table 3.....	6
Changes to Figure 11.....	10
Changes to Theory of Operation.....	13
Changes to Ordering Guide	20

2/03—Revision 0: Initial Version

SPECIFICATIONS

DC SPECIFICATIONS

$AV_{CC} = 5\text{ V}$, $EV_{CC} = 3.3\text{ V}$, $V_{DD} = 3.3\text{ V}$, $T_A = 25^\circ\text{C}$, differential encode = 80 MSPS, $C_{LOAD} \leq 10\text{ pF}$, unless otherwise noted.

Table 1.

Parameter	Test Level	Min	Typ	Max	Unit
RESOLUTION			16		Bits
Offset Error	I	-0.30	+0.12	+0.30	%FS
Gain Error	I	-7		+7	%FS
Differential Nonlinearity (DNL)	V		± 0.7		LSB
Integral Nonlinearity (INL)	V		± 4		LSB
TEMPERATURE DRIFT					
Offset Error	V		13		ppm/ $^\circ\text{C}$
Gain Error	V		200		ppm/ $^\circ\text{C}$
POWER SUPPLY REJECTION RATIO (PSRR)	V		60		dB
ANALOG INPUTS (A_{IN} , \bar{A}_{IN}) ¹					
Differential Input Voltage Range	V		2.15		V p-p
Differential Input Resistance	V		50		Ω
Differential Input Capacitance	V		2.5		nF
Input Bandwidth	IV	0.40		220	MHz
VSWR ²	V		1.04:1		Ratio
POWER SUPPLY ³					
Supply Current					
$I_{AV_{CC}}$ ($AV_{CC} = 5.0\text{ V}$)	I		0.95	1.1	A
$I_{EV_{CC}}$ ($EV_{CC} = 3.3\text{ V}$)	I		0.15	0.2	A
$I_{V_{DD}}$ ($V_{DD} = 3.3\text{ V}$)	I		0.49	0.625	A
Total Power Dissipation ⁴	I		6.86	8.0	W

¹ Measurement includes the recommended interface connector.

² Input VSWR, see Figure 18.

³ Supply voltages should remain stable within $\pm 5\%$ for normal operation.

⁴ Power dissipation measured with encode at rated speed and -6 dBFS analog input at 10 MHz.

DIGITAL SPECIFICATIONS

$AV_{CC} = 5\text{ V}$, $EV_{CC} = 3.3\text{ V}$, $V_{DD} = 3.3\text{ V}$, $T_A = 25^\circ\text{C}$, differential encode = 80 MSPS, $C_{LOAD} \leq 10\text{ pF}$, unless otherwise noted.

Table 2.

Parameter	Test Level	Min	Typ	Max	Unit
ENCODE INPUTS (ENCODE, $\bar{\text{ENCODE}}$)					
Differential Input Voltage Range	IV	0.4			V p-p
Differential Input Resistance	V		100		Ω
Differential Input Capacitance	V		160		pF
LOGIC OUTPUTS (D15 to D0)					
Logic Compatibility			CMOS		
Logic 1 Voltage $I_{LOAD} \leq 100\text{ mA}$	IV		$0.9 \times V_{DD}$		V
Logic 0 Voltage $I_{LOAD} \leq 100\text{ mA}$	IV		0.4		V
Output Coding			True binary		
Series Output Resistance per Bit			120		Ω

AD10678

AC SPECIFICATIONS

$AV_{CC} = 5\text{ V}$, $EV_{CC} = 3.3\text{ V}$, $V_{DD} = 3.3\text{ V}$, $T_A = 25^\circ\text{C}$, differential encode = 80 MSPS, $C_{LOAD} \leq 10\text{ pF}$, unless otherwise noted.

Table 3.

Parameter	Test Level	Min	Typ	Max	Unit
SNR ¹					
Analog Input	2.5 MHz	77.5	80.5		dBFS
@ -6 dBFS	10 MHz	77.5	80.5		dBFS
	30 MHz	77	80.2		dBFS
	70 MHz	76	78		dBFS
SINAD ²					
Analog Input	2.5 MHz	77.2	80.3		dBFS
@ -6 dBFS	10 MHz	77.2	80.3		dBFS
	30 MHz	76.6	79.7		dBFS
	70 MHz	74.7	77.4		dBFS
SFDR ³					
Analog Input	2.5 MHz	88	97.2		dBFS
@ -6 dBFS	10 MHz	88	97.2		dBFS
	30 MHz	84	94.2		dBFS
	70 MHz	81	91.7		dBFS
TWO-TONE ⁴					
Analog Input					
@ -7 dBFS IMD					
f1 = 10 MHz, f2 = 12 MHz	V		96		dBFS
f1 = 70 MHz, f2 = 72 MHz	V		84		dBFS

¹ Analog input signal power at -6 dBFS; signal-to-noise (SNR) is the ratio of signal level to total noise (first five harmonics removed). Encode = 80 MSPS. SNR is reported in dBFS, related back to converter full scale.

² Analog input signal power at -6 dBFS; signal-to-noise and distortion (SINAD) is the ratio of signal level to total noise + harmonics. Encode = 80 MSPS. SINAD is reported in dBFS, related back to converter full scale.

³ Analog input signal equals -6 dBFS; SFDR is the ratio of the converter full scale to the worst spur.

⁴ Both input tones at -7 dBFS; two-tone intermodulation distortion (IMD) rejection is the ratio of either tone to the worst third-order intermodulation product.

SWITCHING SPECIFICATIONS

$A_{V_{CC}} = 5\text{ V}$, $E_{V_{CC}} = 3.3\text{ V}$, $V_{DD} = 3.3\text{ V}$, $T_A = 25^\circ\text{C}$, differential encode = 80 MSPS, $C_{LOAD} \leq 10\text{ pF}$, unless otherwise noted.

Table 4.

Parameter	Test Level	Min	Typ	Max	Unit
MAXIMUM CONVERSION RATE	I	80			MSPS
MINIMUM CONVERSION RATE	IV			30	MSPS
DUTY CYCLE	IV	40		60	%
ENCODE INPUTS PARAMETERS					
Encode Period @ 80 MSPS, t_{ENC}	V		12.5		ns
Encode Pulse Width High @ 80 MSPS, t_{ENCH}	V		6.25		ns
Encode Pulse Width Low @ 80 MSPS, t_{ENCL}	V		6.25		ns
ENCODE/DATA (D15:D0)					
Propagation Delay, t_{PDH}			6.7		ns
Valid Time, t_{PDL}			7.3		ns
ENCODE/DATA READY ¹					
Encode Rising to Data Ready Falling, t_{DR_F}			12.6		ns
Encode Rising to Data Ready Rising, t_{DR_R}			6.4		ns
DATA READY/DATA ¹					
Data Ready to Data (Hold Time) t_{H_DR}			10		ns
Data Ready to Data (Setup Time) t_{S_DR}			1		ns
APERTURE DELAY, t_A	V		480		ps
APERTURE UNCERTAINTY (JITTER), t_J	V		500		fs rms
PIPELINE DELAYS	V		10		Cycles

¹ Duty cycle = 50%.

ABSOLUTE MAXIMUM RATINGS

Table 5.

Parameter	Rating
AV_{CC} to AGND	0 V to 7 V
EV_{CC} to AGND	0 V to 6 V
V_{DD} to DGND	-0.5 V to +3.8 V
Analog Input Voltage	0 V to AV_{CC}
Analog Input Current	25 mA
Encode Input Voltage	0 V to 5 V
Digital Output Voltage	-0.5 V to V_{DD}
Maximum Junction Temperature	150°C
Storage Temperature Range Ambient	-65°C to +150°C
Maximum Operating Temperature Ambient	92°C

Table 6. Output Coding (True Binary)

Code	AIN (V)	Digital Output
65535	+1.1	1111 1111 1111 1111
.	.	.
.	.	.
.	.	.
32768	0	1000 0000 0000 0000
32767	-0.000034	0111 1111 1111 1111
.	.	.
.	.	.
.	.	.
0	-1.1	0000 0000 0000 0000

Stresses above those listed under Absolute Maximum Ratings may cause permanent damage to the device. This is a stress rating only; functional operation of the device at these or any other conditions above those indicated in the operational section of this specification is not implied. Exposure to absolute maximum rating conditions for extended periods may affect device reliability.

EXPLANATION OF TEST LEVELS

- I. 100% production tested.
- II. 100% production tested at 25°C and sample tested at specified temperatures.
- III. Sample tested only.
- IV. Parameter is guaranteed by design and characterization testing.
- V. Parameter is a typical value only.

100% production tested at 25°C; guaranteed by design and characterization testing for industrial temperature range; 100% production tested at temperature extremes for military devices.

OPERATING RANGE

Operating ambient temperature range: 0°C to 70°C. See the Thermal Considerations section.

ESD CAUTION

ESD (electrostatic discharge) sensitive device. Electrostatic charges as high as 4000 V readily accumulate on the human body and test equipment and can discharge without detection. Although this product features proprietary ESD protection circuitry, permanent damage may occur on devices subjected to high energy electrostatic discharges. Therefore, proper ESD precautions are recommended to avoid performance degradation or loss of functionality.



TEST CIRCUITS

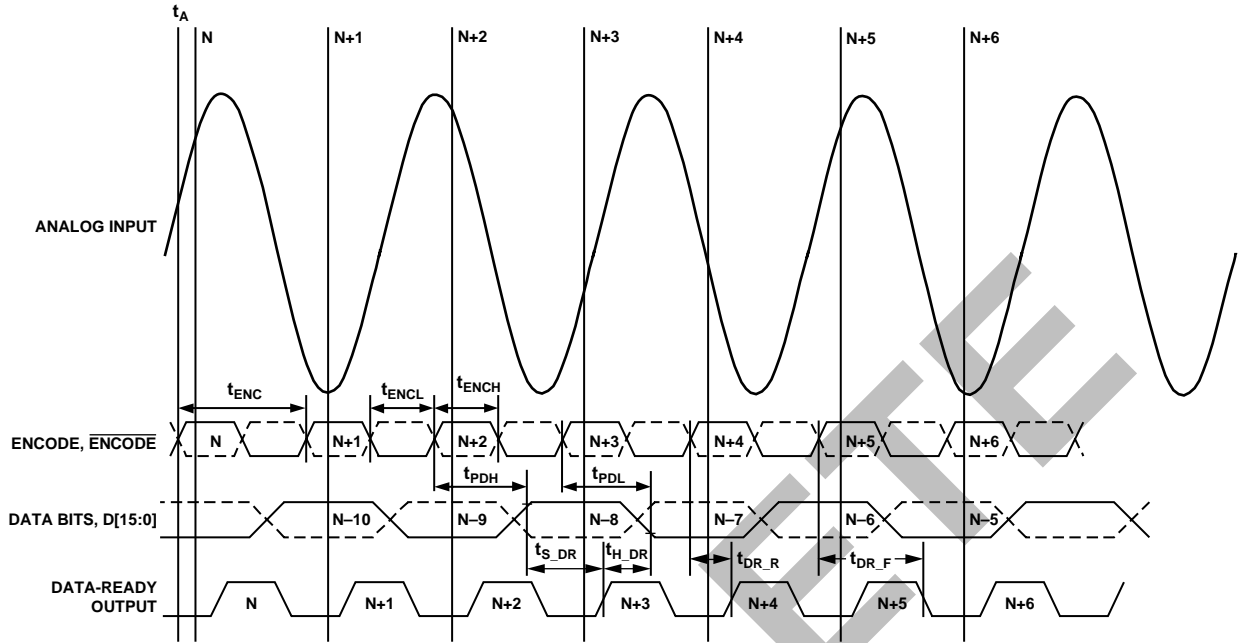

Figure 2. Timing Diagram

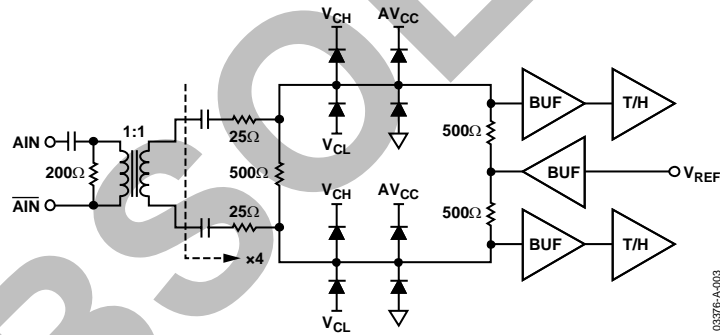

Figure 3. Analog Input Stage

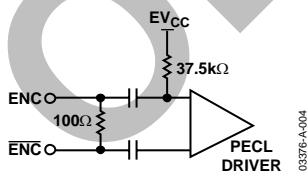

Figure 4. Equivalent Encode Input



Figure 5. Digital Output Stage

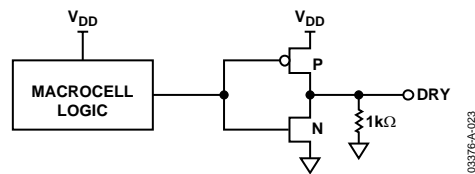

Figure 6. Data-Ready Output

PIN CONFIGURATIONS AND FUNCTION DESCRIPTIONS

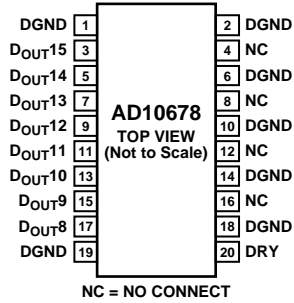

Figure 7. Pin Configuration P1
(See Figure 22)

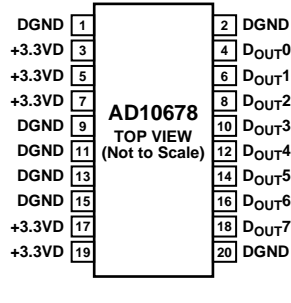

Figure 8. Pin Configuration P2
(See Figure 22)

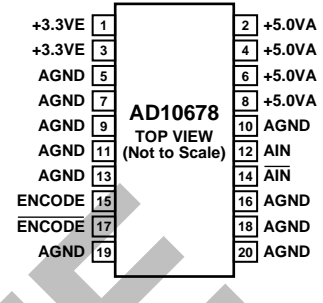

Figure 9. Pin Configuration P3
(See Figure 22)

Table 7. Pin Function Descriptions

P1 Pin No. ¹	P2 Pin No. ²	P3 Pin No. ³	Mnemonic	Description
1, 2, 6, 10, 14, 18, 19	1, 2, 9, 11, 13, 15, 20	N/A	DGND	Digital Ground.
3, 5, 7, 9, 11, 13, 15, 17	4, 6, 8, 10, 12, 14, 16, 18	N/A	D _{OUT} X	Data Bit Output.
N/A	3, 5, 7, 17, 19	N/A	+3.3VD	Digital Voltage (V _{DD}).
4, 8, 12, 16	N/A	N/A	NC	No Connection.
20	N/A	N/A	DRY	Data Ready Output.
N/A	N/A	1, 3	+3.3VE	Encode Voltage (EV _{CC}).
N/A	N/A	2, 4, 6, 8	+5.0VA	Analog Voltage (AV _{CC}).
N/A	N/A	5, 7, 9 to 11, 13, 16, 18 to 20	AGND	Analog Ground.
N/A	N/A	12	AIN	Analog Input.
N/A	N/A	14	$\overline{\text{AIN}}$	Analog Input (Complement).
N/A	N/A	15	ENCODE	Encode Input.
N/A	N/A	17	$\overline{\text{ENCODE}}$	Encode Input (Complement).

¹ Equivalent pin configuration in Figure 22 is J12.

² Equivalent pin configuration in Figure 22 is J11.

³ Equivalent pin configuration in Figure 22 is J13.

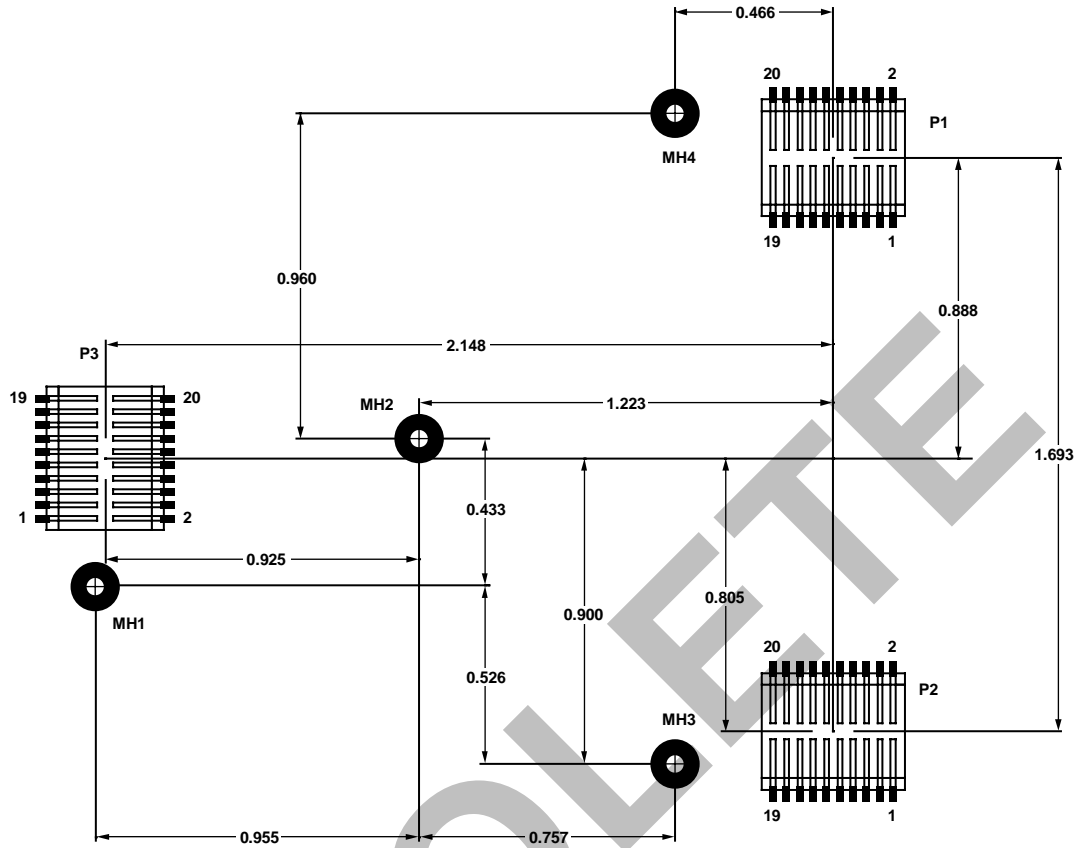

INTERFACE NOTES:
 SUGGESTED INTERFACE MANUFACTURER: SAMTEC
 INTERFACE PART NUMBERS FOR P1-P3: FSI-110-03-G-D-AD-K-TR (20-PIN)
 HOLES 1-4 ACCOMMODATE 2-56 THREADED HARDWARE. USE FOUR 2-56 NUTS FOR SECURING THE PART TO INTERFACE PCB.
 MANUFACTURER: BUILDING FASTENERS
 PART NUMBER: HNSS256
 DIGIKEY #: H723-ND
 ALL METAL HARDWARE TO BE TORQUED TO 1.0 INCH-POUND.
 CARE MUST BE TAKEN WHEN TIGHTENING HARDWARE ADJACENT TO SURFACE-MOUNTED COMPONENTS TO AVOID DAMAGE.

TOLERANCES: 0.xxx = ±5mils

Figure 10. Interface PCB Assembly, Top View
 (Dimensions Shown in Inches)

03376-C-006

TYPICAL PERFORMANCE CHARACTERISTICS

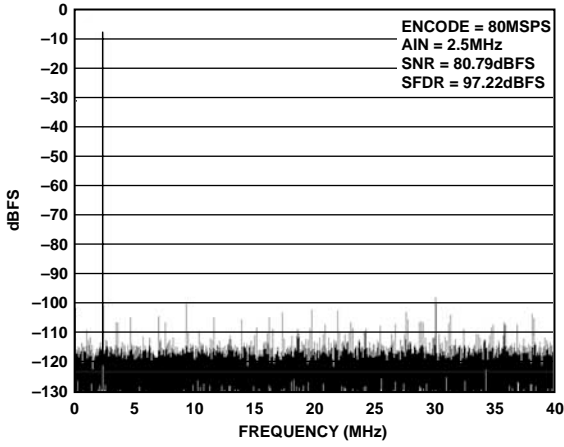

Figure 11. Single-Tone at 2.5 MHz

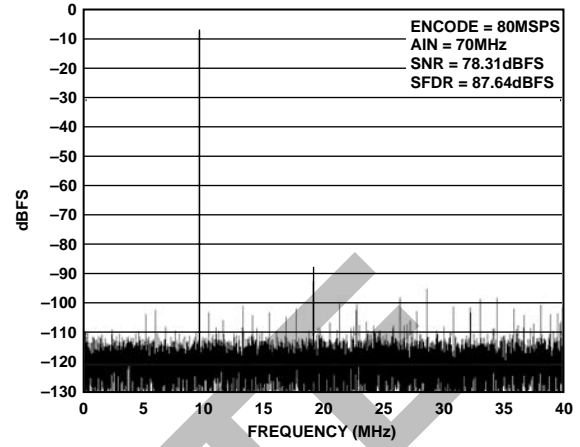

Figure 14. Single-Tone at 70 MHz

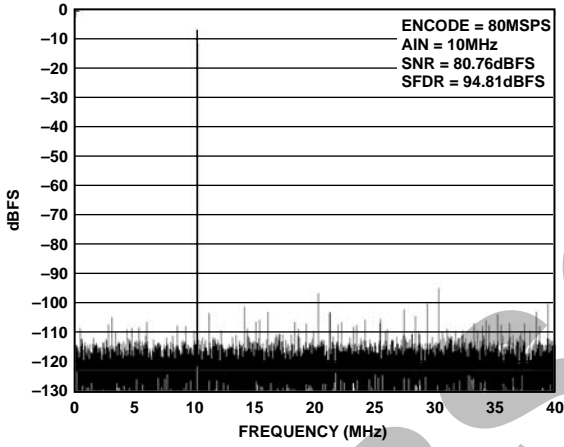

Figure 12. Single-Tone at 10 MHz

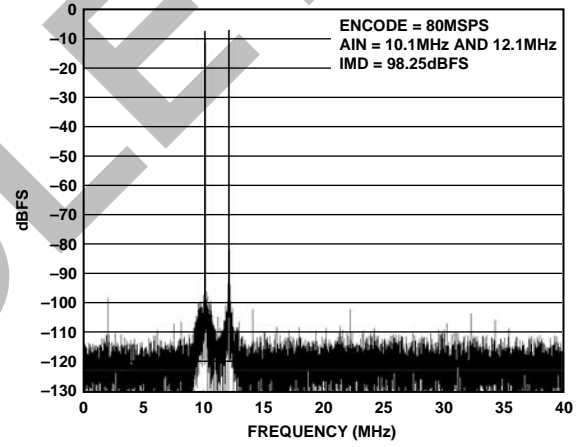

Figure 15. Two-Tone at 10.1 MHz and 12.1 MHz

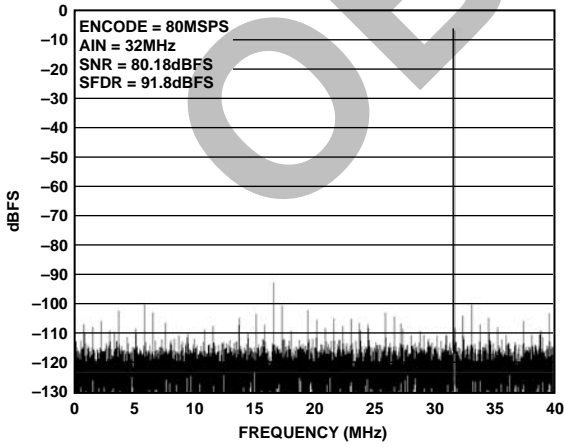

Figure 13. Single-Tone at 32 MHz

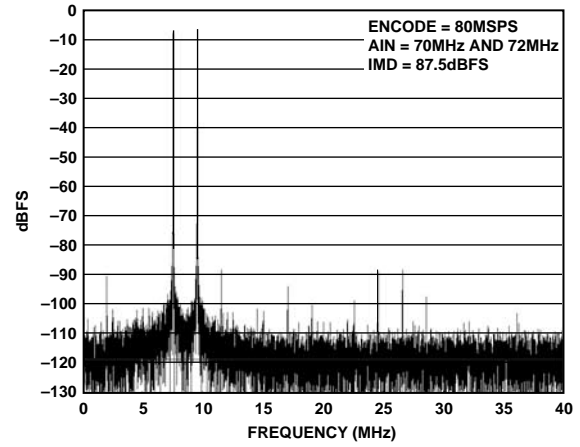

Figure 16. Two-Tone at 70 MHz and 72 MHz

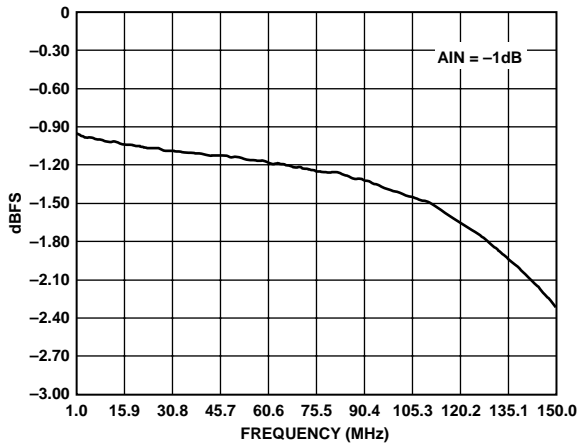

Figure 17. Gain Flatness

03376-A-013

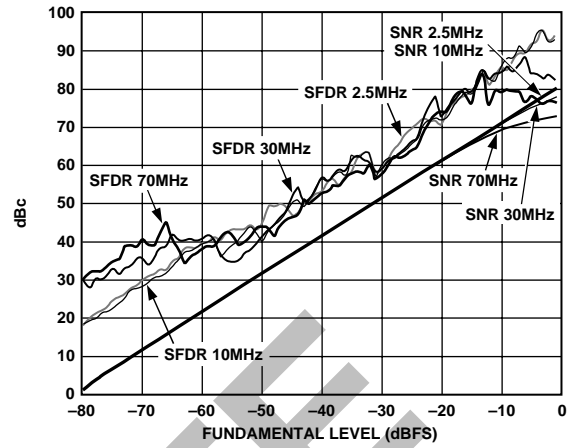

Figure 19. SFDR and SNR vs. Analog Input Level

03376-A-015

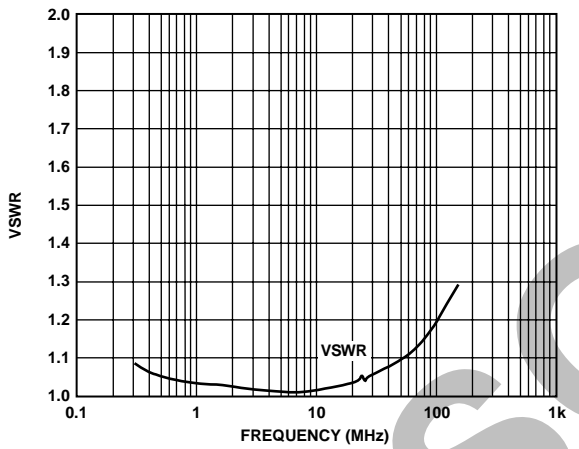

Figure 18. Analog Input VSWR

03376-A-014

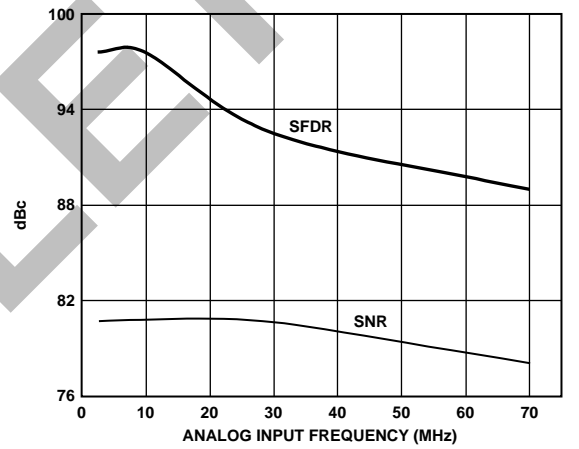

Figure 20. SFDR and SNR vs. Analog Input Frequency

03376-A-024

TERMINOLOGY

Analog Bandwidth

The analog input frequency at which the spectral power of the fundamental frequency (as determined by the FFT analysis) is reduced by 3 dB.

Aperture Delay

The delay between the 50% point on the rising edge of the ENCODE command and the instant at which the analog input is sampled.

Aperture Uncertainty (Jitter)

The sample-to-sample variation in aperture delay.

Differential Nonlinearity (DNL)

The deviation of any code from an ideal 1 LSB step.

Encode Pulse Width/Duty Cycle

Pulse width high is the minimum amount of time that the encode pulse should be left in Logic 1 state to achieve rated performance; pulse width low is the minimum time that the encode pulse should be left in low state. At a given clock rate, these specifications define an acceptable encode duty cycle.

Integral Nonlinearity (INL)

The deviation of the transfer function from a reference line measured in fractions of 1 LSB using a best straight line determined by a least square curve fit.

Harmonic Distortion

The ratio of the rms signal amplitude to the rms value of the worst harmonic component.

Maximum Conversion Rate

The encode rate at which parametric testing is performed.

Minimum Conversion Rate

The encode rate at which the SNR of the lowest analog signal frequency drops by no more than 3 dB below the guaranteed limit.

Output Propagation Delay

The delay between the 50% point of the rising edge of the ENCODE command and the time when all output data bits are within valid logic levels.

Power Supply Rejection Ratio (PSRR)

The ratio of a change in output offset voltage to a change in power supply voltage.

Signal-to-Noise and Distortion (SINAD)

The ratio of the rms signal amplitude (set at 1 dB below full scale) to the rms value of the sum of all other spectral components, including the first five harmonics and dc. Can be reported in dBc (that is, degrades as signal level is lowered) or in dBFS (always related back to converter full scale).

Signal-to-Noise Ratio (SNR)

The ratio of the rms signal amplitude (set at 1 dB below full scale) to the rms value of the sum of all other spectral components, excluding the first five harmonics and dc. Can be reported in dBc (that is, degrades as signal level is lowered) or in dBFS (always related back to converter full scale).

Spurious-Free Dynamic Range (SFDR)

The ratio of the rms signal amplitude to the rms value of the peak spurious spectral component. The peak spurious component may or may not be an harmonic. Can be reported in dBc (such as, degrades as signal level is lowered) or in dBFS (always related back to converter full scale).

Two-Tone Intermodulation Distortion Rejection (IMD)

Ratio of the rms value of either input tone to the rms value of the worst third-order intermodulation product; reported in dBc.

Voltage Standing-Wave Ratio (VSWR)

The ratio of the amplitude of the elective field at a voltage maximum to that at an adjacent voltage minimum.

THEORY OF OPERATION

The AD10678 uses four parallel, high speed ADCs in a correlation technique to improve the dynamic range of the ADCs. The technique consists of summing the parallel outputs of the four converters to reduce the uncorrelated noise introduced by the individual converters. Signals processed through the high speed adder are correlated and summed coherently. Noise is not correlated and sums on an rms basis.

The four high speed ADCs use a three-stage subrange architecture. The AD10678 provides complementary analog input pins, \overline{AIN} and $A\overline{IN}$. Each analog input is centered around 2.4 V and should swing ± 0.55 V around the reference. Because \overline{AIN} and $A\overline{IN}$ are 180 degrees out of phase, the differential analog input signal is 2.15 V p-p.

The analog input is designed for a 50 Ω input impedance for easy interface to commercially available cables, filters, drivers, and so on.

The AD10678 encode inputs are ac-coupled to a PECL differential receiver/driver. The output of the receiver/driver provides a clock source for a 1:5 PECL clock driver and a PECL-to-TTL translator. The 1:5 PECL clock driver provides the differential encode signal for each of the four high speed ADCs. The PECL-to-TTL translator provides a clock source for the complex programmable logic device (CPLD).

The digital outputs from the four ADCs drive 120 Ω series output terminators and are applied to the CPLD for post-processing. The digital outputs are added together in the complex programmable logic device through a ripple-carry adder, which provides the 16-bit data output. The AD10678 provides valid data following 10 pipeline delays. The result is a 16-bit parallel digital CMOS-compatible word coded as true binary.

THERMAL CONSIDERATIONS

Due to the high power nature of the part, it is critical that the following thermal conditions be met for the part to perform to data sheet specifications. This also ensures that the maximum junction temperature (150°C) is not exceeded.

- Operation temperature (T_A) must be within 0°C to 70°C.
- All mounting standoffs should be fastened to the interface PCB assembly with 2-56 nuts. This ensures good thermal paths as well as excellent ground points.
- The unit rises to $\sim 72^\circ\text{C}$ (T_C) on the heat sink in still air (0 linear feet per minute (LFM)). The minimum recommended air flow is 100 linear feet per minute (LFM) in either direction across the heat sink (see Figure 21).

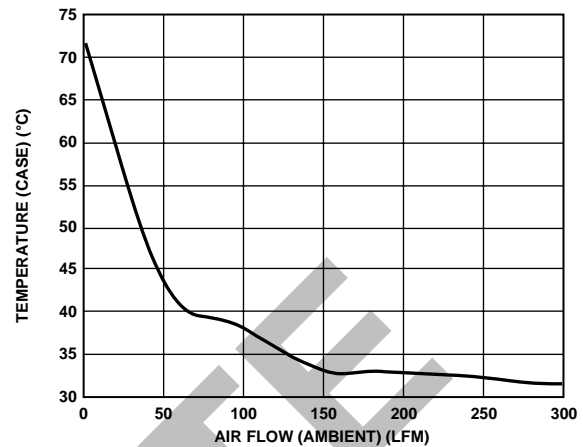

Figure 21. Temperature (Case) vs. Air Flow (Ambient)

INPUT STAGE

The user is provided with a single-to-differential transformer-coupled input. The input impedance is 50 Ω and requires a 2.15 V p-p input level to achieve full scale.

ENCODING THE AD10678

The AD10678 encode signal must be a high quality, low phase noise source to prevent performance degradation. The clock input must be treated as an analog input signal because aperture jitter can affect dynamic performance. For optimum performance, the AD10678 must be clocked differentially.

OUTPUT LOADING

Take care when designing the data receivers for the AD10678. The complex, programmable logic device, 16-bit outputs drive 120 Ω series resistors to limit the amount of current that can flow into the output stage. To minimize capacitive loading, there should be only one gate on each of the output pins. A typical CMOS gate combined with the PCB trace has a load of approximately 10 pF. Note that extra capacitive loading increases output timing and invalidates timing specifications. Digital output timing is guaranteed with a 10 pF load.

ANALOG AND DIGITAL POWER SUPPLIES

Care must be taken when selecting a power source. Linear supplies are recommended. Switching supplies tend to have radiated components that can be coupled into the ADCs. The AD10678 features separate analog and digital supply and ground currents, helping to minimize digital corruption of sensitive analog signals.

AD10678

The +3.3 VE supply provides power to the clock distribution circuit. The +3.3 VD supply provides power to the digital output section of the ADCs, the PECL-to-TTL translator, and the CPLD. Separate +3.3 VE and +3.3 VD supplies are used to prevent modulation of the clock signal with digital noise.

The +5.0 VA supply provides power to the analog sections of the ADCs. Decoupling capacitors are strategically placed throughout the circuit to provide low impedance noise shunts to ground. The +5.0 VA supply (analog power) should be decoupled to analog ground (AGND), and +3.3 VD (digital power) should be decoupled to digital ground (DGND). The +3.3 VE supply (analog power) should be decoupled to AGND. The evaluation board schematic and layout data provide a typical PCB implementation of the AD10678. Table 8 shows the PCB bill of materials.

ANALOG AND DIGITAL GROUNDING

Although the AD10678 provides separate analog and digital ground pins, the device should be treated as an analog component. Proper grounding is essential in high speed, high resolution systems. Multilayer printed circuit boards are recommended to provide optimal grounding and power distribution. The use of power and ground planes provides distinct advantages. Power and ground planes minimize the loop area encompassed by a signal and its return path, minimize the impedance associated with power and ground paths, and provide a distributed capacitor formed by the power plane, printed circuit board material, and ground plane. The AD10678 unit has four metal standoff (see Figure 10). MH2 is located in the center of the unit and MH1 is located directly below analog header P3. Both of these standoffs are tied to analog ground and should be connected accordingly on the

next level assembly for optimum performance. The two standoffs located near P1 and P2 (MH3 and MH4) are tied to digital ground and should be connected accordingly on the next-level assembly.

OTHER NOTES

The circuit is configured on a 2.2 inch × 2.8 inch laminate board with three sets of connector interface pads. The pads are configured to provide easy keying for the user. The pads are made for low profile applications and have a total height of 0.12 inches after mating. The part numbers for the header mates are provided in Figure 10. All pins of the analog and digital sections are described in the Pin Configurations and Function Descriptions section.

EVALUATION BOARD

The AD10678 evaluation board provides an easy way to test the 16-bit, 80 MSPS ADC. The board requires a clock source, an analog input signal, two 3.3 V power supplies, and a 5 V power supply. The clock source is buffered on the board to provide a latch, a data ready signal, and the clock for the AD10678. To use the AD10678 data ready output to clock the buffer memory, remove R24 (0.0 Ω) and install a 0.0 Ω resistor at R31 (DNI). The ADC digital outputs are latched on board by a 74LCX16374. The digital outputs and output clock are available on a 40-pin connector, J1. Power is supplied to the board via uninsulated metal banana jacks.

The analog input is connected via an SMA connector, AIN. The analog input section provides a single-ended input option or a differential input option. The board is shipped in a single-ended analog input option. Removing a ground tie at E17 converts the circuit to a differential analog input configuration.

Table 8. PCB Bill of Materials

Item	Quantity	Reference Designator	Description
1	1	J1	Connector, 40-position header, male straight
2	1	U1	IC, LV 16-bit, D-type flip-flop with 5 V tolerant I/O
3	3	L1 to L3	Common-mode surface-mount ferrite bead 20 Ω
4	3	J11 to J13	Connector, 1 mm single-element interface
5	6	P1, P2, P8 to P10, P12	Uninsulated banana jack, all metal
6	2	U5, U6	IC, 3.3 V/5 V ECL differential receiver/driver
7	1	U7	IC, 3.3 V dual differential LVPECL to LVTTTL translator
8	1	R24	RES 0.0 Ω 1/10 W 5% 0805 SMD
9	19	R0 to R16, R20, R23	RES 51.1 Ω 1/10 W 1% 0805 SMD
10	1	R17	RES 18.2 kΩ 1/10 W 1% 0805 SMD
11	4	R18, R19, R21, R22	RES 100 Ω 1/10 W 1% 0805 SMD
12	17	C1, C10 to C13, C16 to C18, C23 to C26, C28 to C32	CAP 0.1 μF 16 V ceramic X7R 0805
13	6	C8, C9, C4, C15, C27, C33	CAP 10 μF 10 V ceramic Y5V 1206
14	4	J2, J3, J5, J6	Connector, SMA jack 200 Mil STR gold
15	1	A1	Assembly, AD10678BWS
16	1	AD106xx Evaluation Board	GS04483 (PCB)

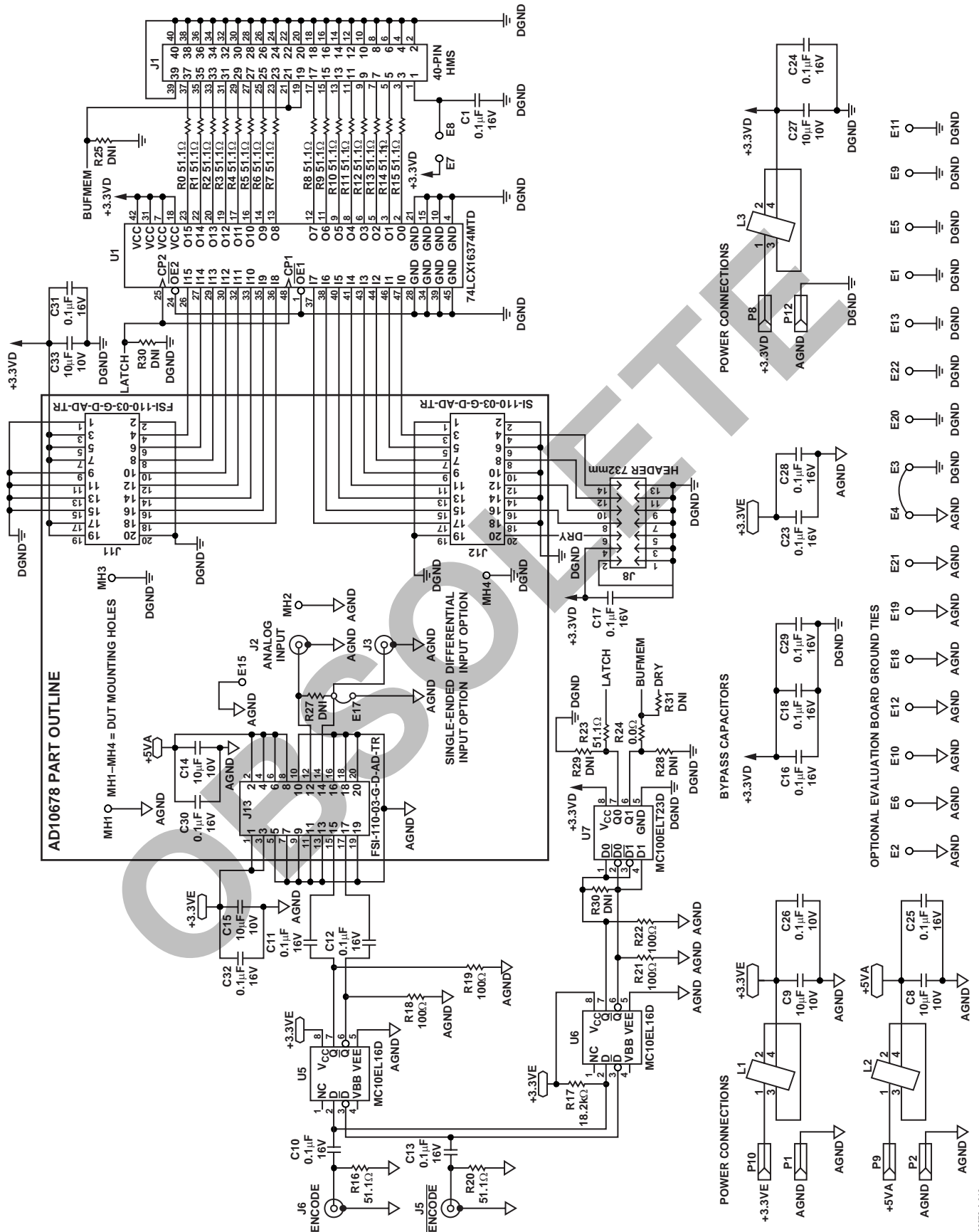

Figure 22. Evaluation Board Schematic

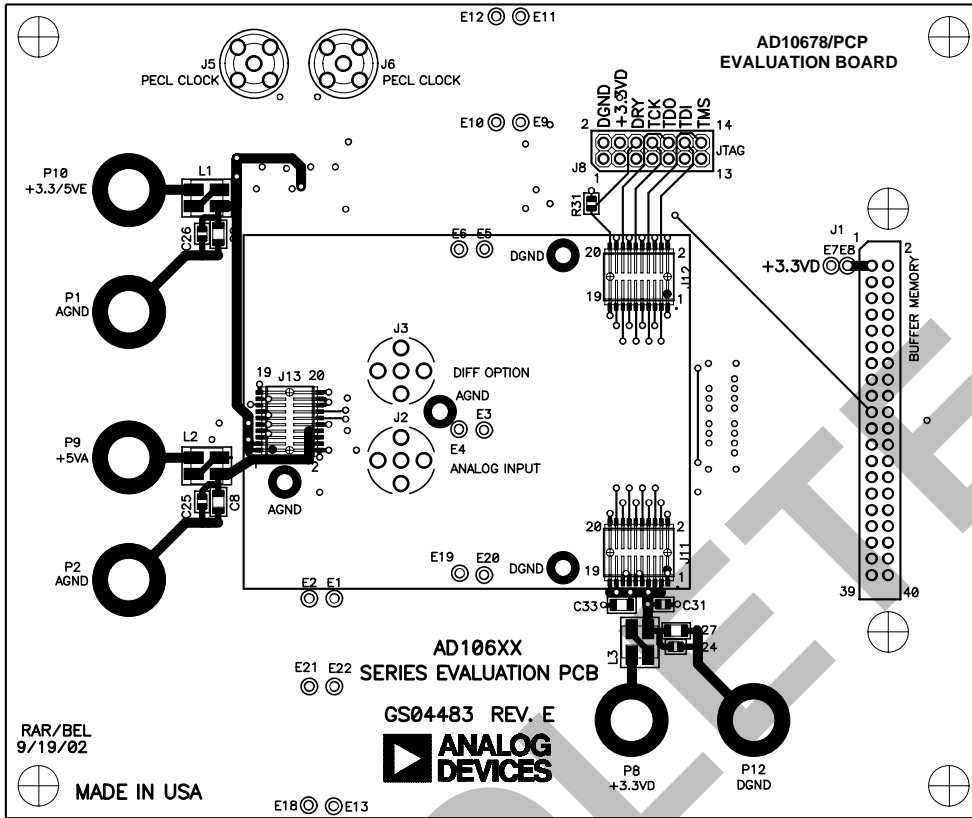

Figure 23. Evaluation Board Mechanical Layout, Top View

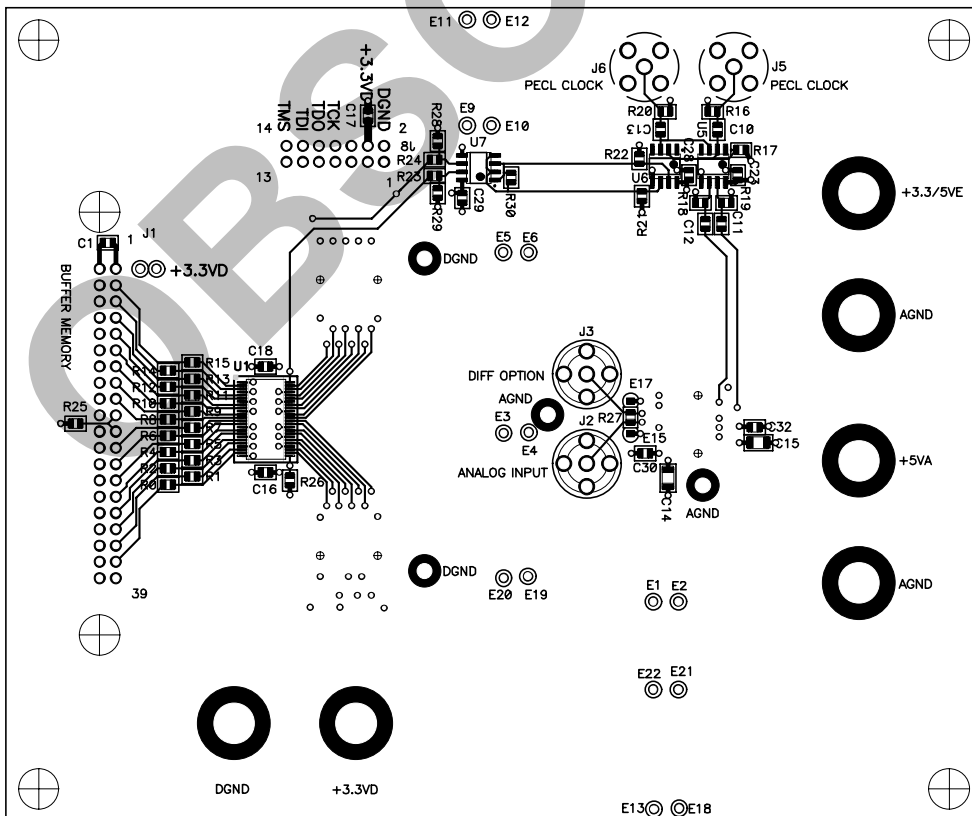
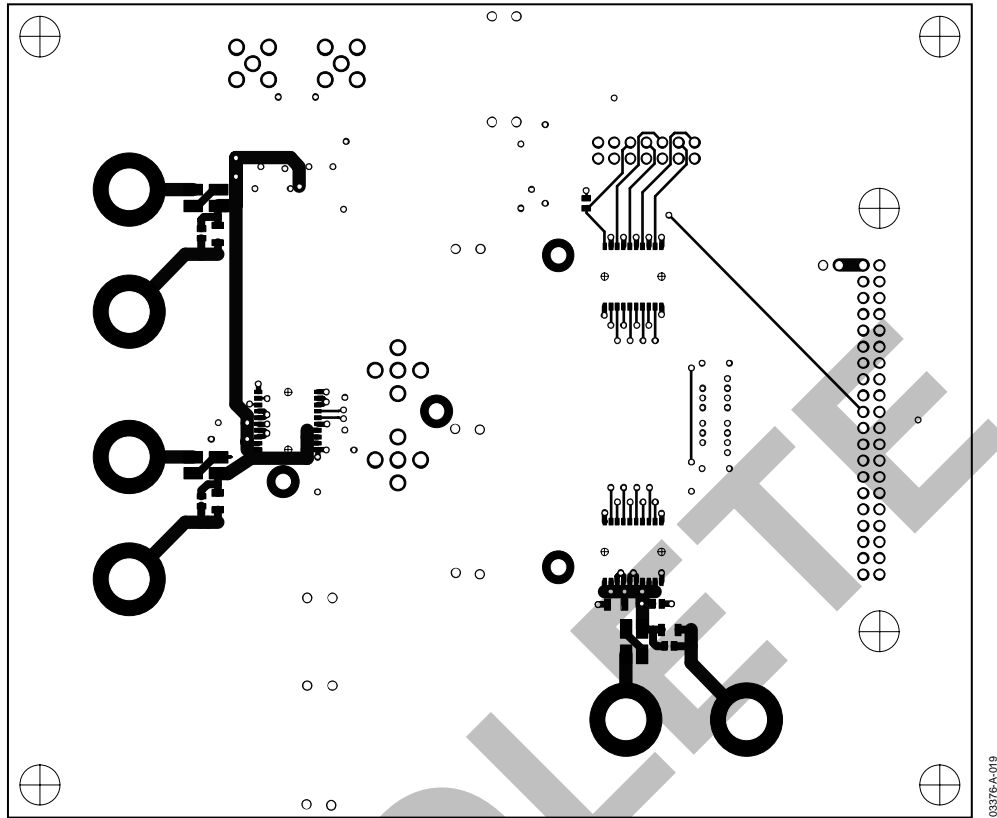
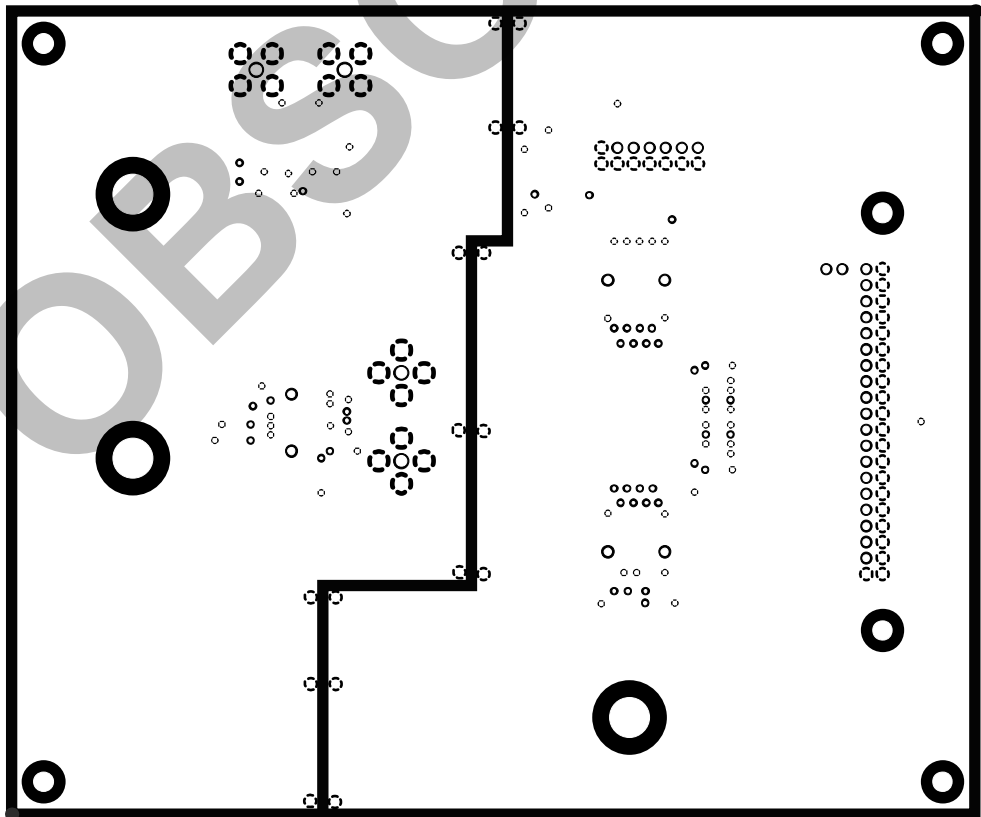

Figure 24. Evaluation Board Mechanical Layout, Bottom View



03376-A-019

Figure 25. Evaluation Board Top Layer Copper



03376-A-020

Figure 26. Evaluation Board Second Layer Copper

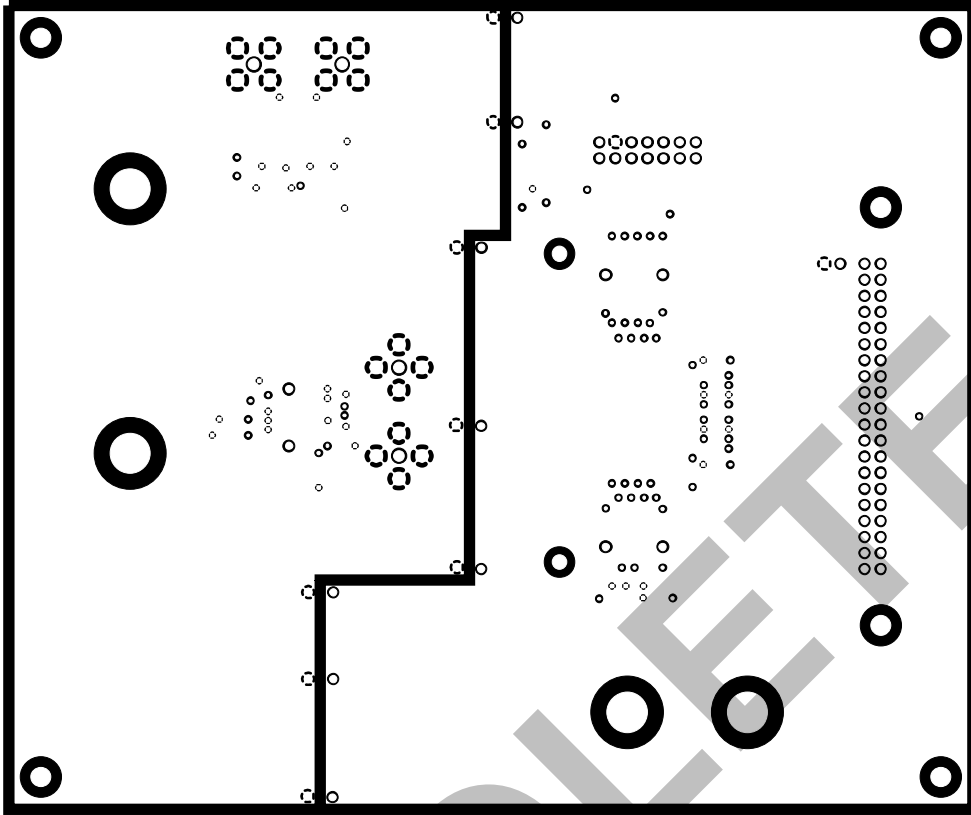

03376-A-021

Figure 27. Evaluation Board Third Layer Copper

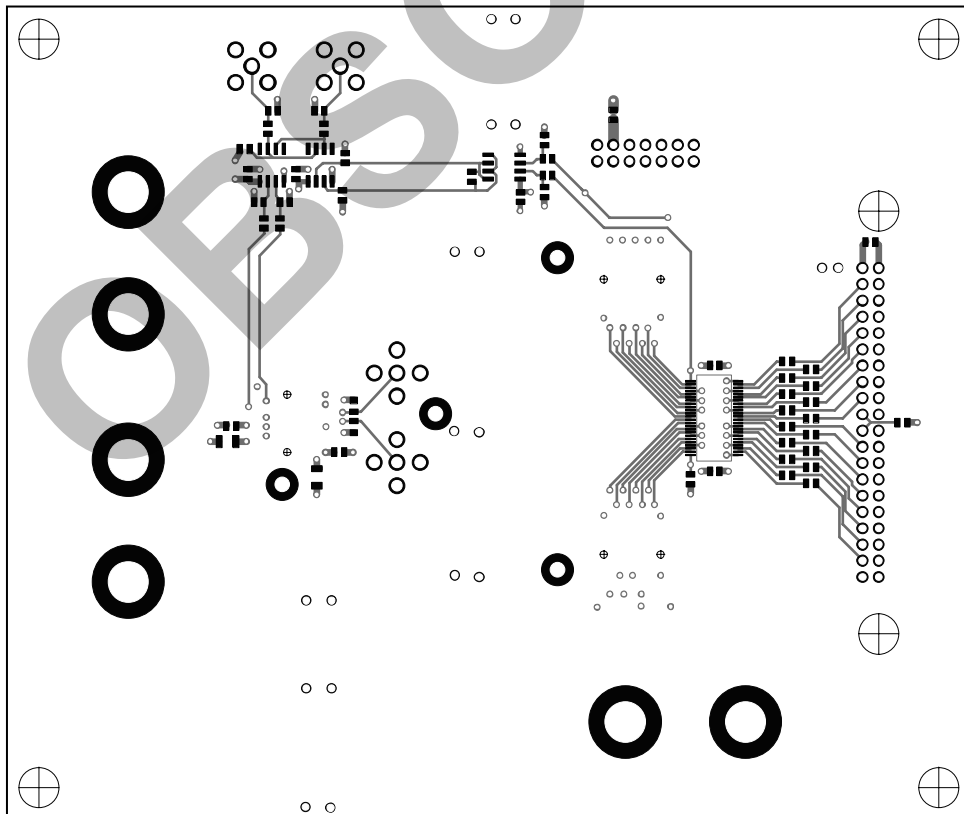

03376-A-022

Figure 28. Evaluation Board Bottom Layer Copper

OUTLINE DIMENSIONS

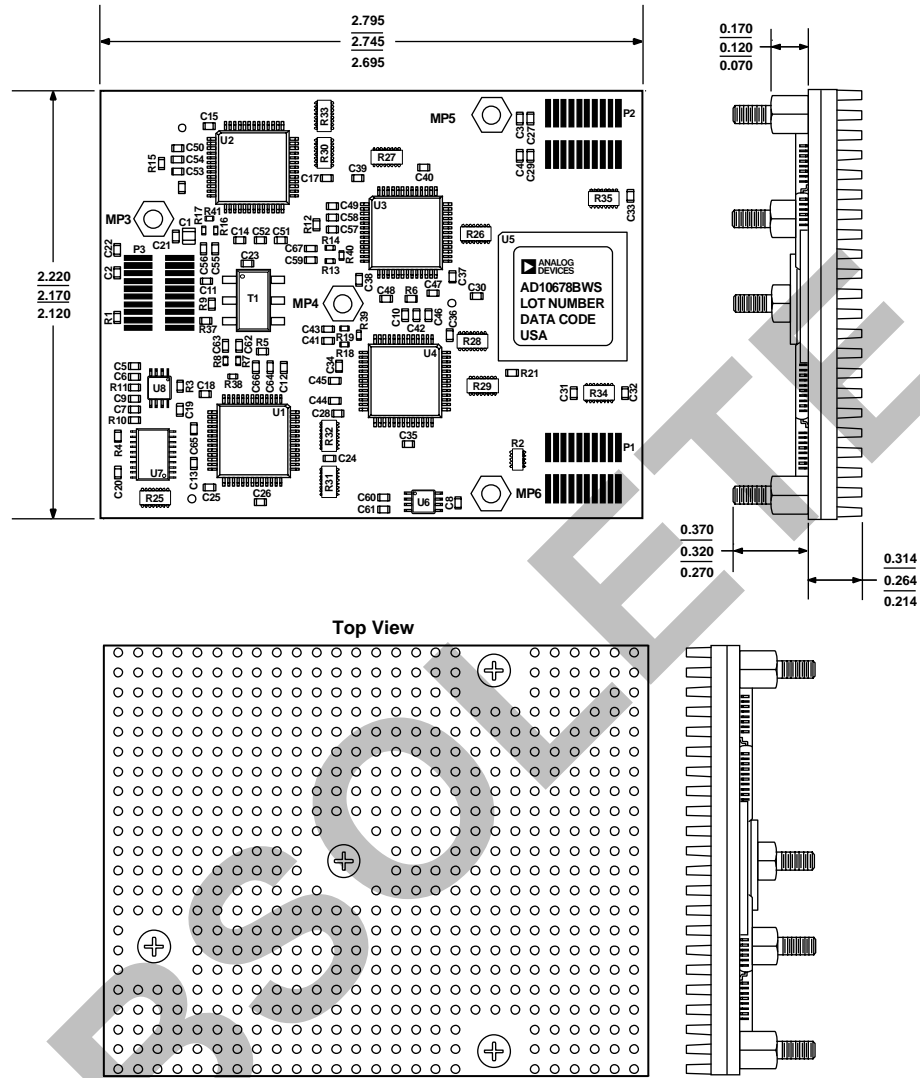

ORDERING GUIDE

Model	Temperature Range	Package Description	Package Option
AD10678BWS	0°C to 70°C	Non-Herm Hybrid Surface Mount (2.2" × 2.8")	WS-120
AD10678/PCB		Evaluation Board	

AD10678

NOTES

OBSOLETE