



ATTENTION
OBSERVE PRECAUTIONS
FOR HANDLING
ELECTROSTATIC
DISCHARGE
SENSITIVE
DEVICES

Part Number: ACSA08-51ZGWA

Green

Features

- 0.8 inch digit height.
- Low current operation.
- Excellent character appearance.
- Mechanically rugged.
- Gray face, white segment.
- Package: 200pcs/ reel
- Moisture sensitivity level : level 2a.
- RoHS compliant.

Description

The Green source color devices are made with InGaN on Sapphire Light Emitting Diode.

Static electricity and surge damage the LEDs.

It is recommended to use a wrist band or anti-electrostatic glove when handling the LEDs.

All devices, equipment and machinery must be electrically grounded.

Package Dimensions & Internal Circuit Diagram

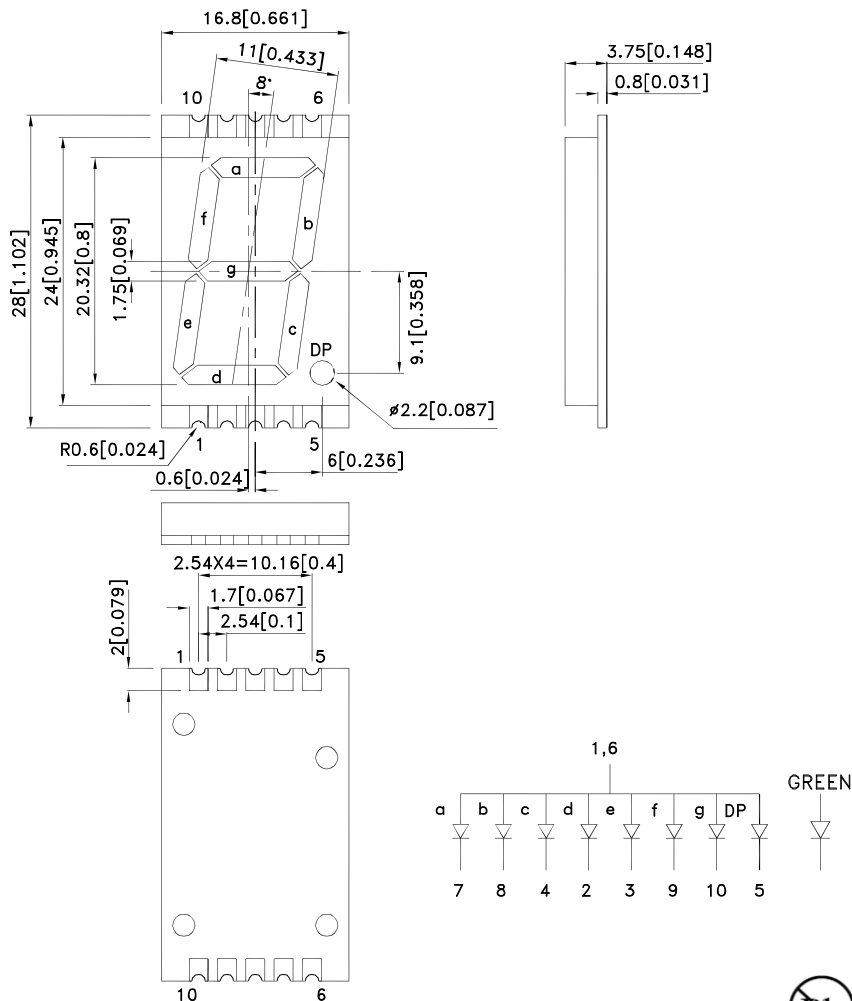

Notes:

1. All dimensions are in millimeters (inches), Tolerance is $\pm 0.25(0.01)$ unless otherwise noted.
2. The specifications, characteristics and technical data described in the datasheet are subject to change without prior notice.
3. The gap between the reflector and PCB shall not exceed 0.25mm.



Selection Guide

Part No.	Dice	Lens Type	Iv (ucd) [1] @ 10mA		Description
			Min.	Typ.	
ACSA08-51ZGWA	Green (InGaN)	White Diffused	52000	100000	Common Anode, Rt. Hand Decimal.

Notes:

- Luminous intensity/ luminous Flux: +/-15%.
- Luminous intensity value is traceable to the CIE127-2007 compliant national standards.

Electrical / Optical Characteristics at TA=25°C

Symbol	Parameter	Device	Typ.	Max.	Units	Test Conditions
λ_{peak}	Peak Wavelength	Green	515		nm	I _F =20mA
λ_D [1]	Dominant Wavelength	Green	525		nm	I _F =20mA
$\Delta\lambda_{1/2}$	Spectral Line Half-width	Green	30		nm	I _F =20mA
C	Capacitance	Green	45		pF	V _F =0V;f=1MHz
V _F [2]	Forward Voltage	Green	3.3	4.1	V	I _F =20mA
I _R	Reverse Current	Green		50	uA	V _R =5V

Notes:

- Wavelength: +/-1nm.
- Forward Voltage: +/-0.1V.
- Wavelength value is traceable to the CIE127-2007 compliant national standards.

Absolute Maximum Ratings at TA=25°C

Parameter	Green	Units
Power dissipation	102.5	mW
DC Forward Current	25	mA
Peak Forward Current [1]	150	mA
Reverse Voltage	5	V
Operating / Storage Temperature	-40°C To +85°C	

Note:

- 1/10 Duty Cycle, 0.1ms Pulse Width.

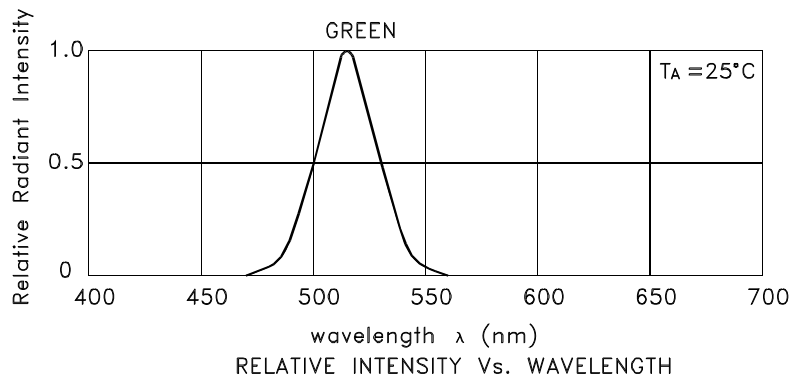

Green

ACSA08-51ZGWA

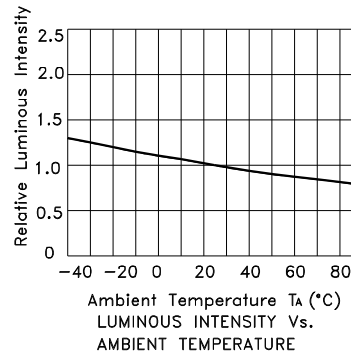
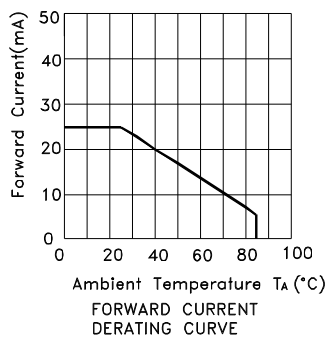
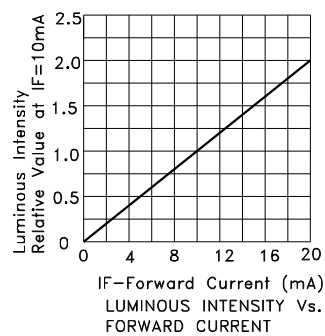
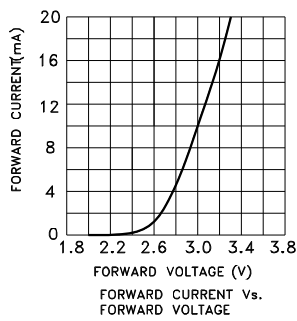

CIRCUIT DESIGN NOTES

1. Protective current-limiting resistors may be necessary to operate the Displays.
2. LEDs mounted in parallel should each be placed in series with its own current-limiting resistor.

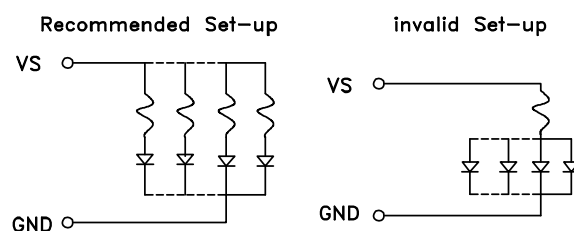

ACSA08-51ZGWA

Reflow Soldering Profile For Lead-free SMT Process.



NOTES:

1. We recommend the reflow temperature 245°C(+/-5°C). The maximum soldering temperature should be limited to 260°C.
2. Don't cause stress to the epoxy resin while it is exposed to high temperature.
3. Number of reflow process shall be 2 times or less.

Recommended Soldering Pattern (Units : mm; Tolerance: ± 0.15)

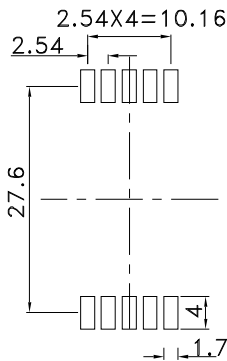

Reel Dimension

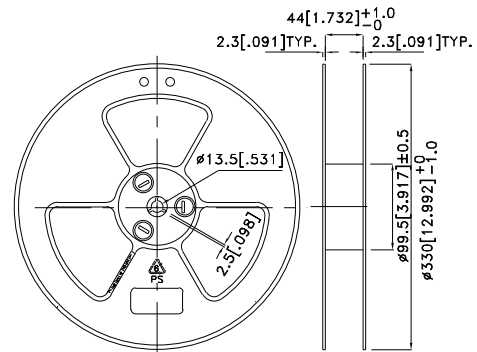

Tape Specifications (Units : mm)

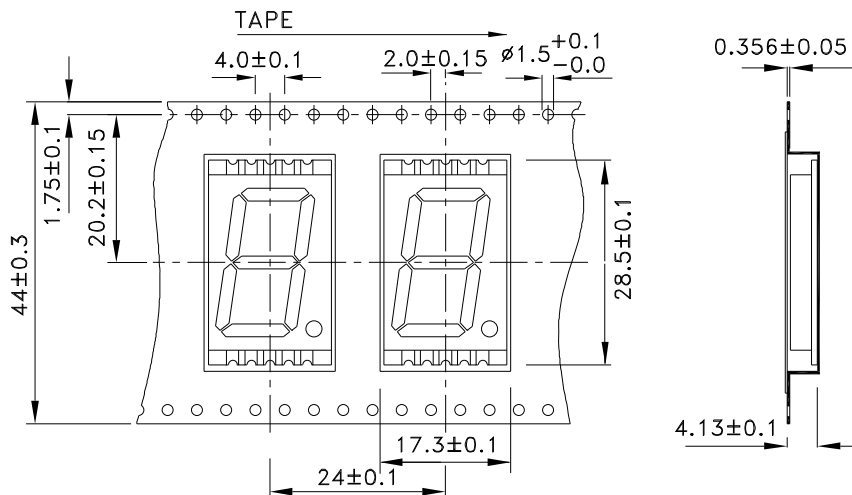

PACKING & LABEL SPECIFICATIONS

ACSA08-51ZGWA

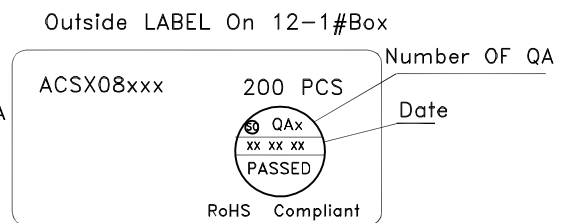
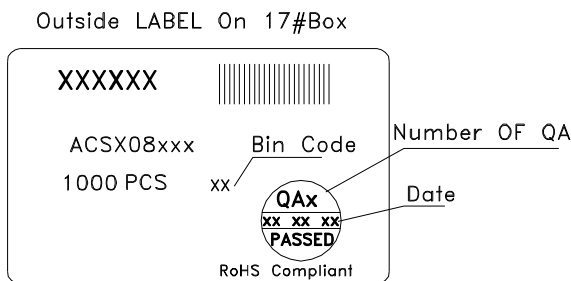
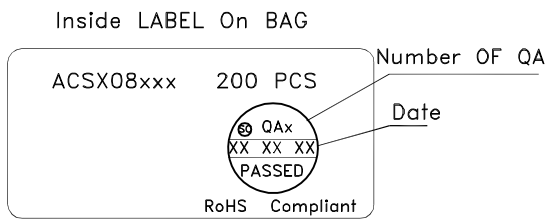
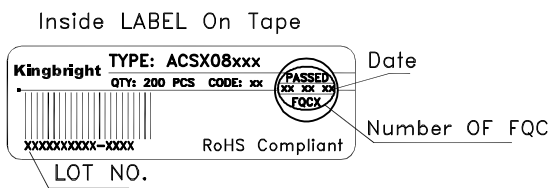
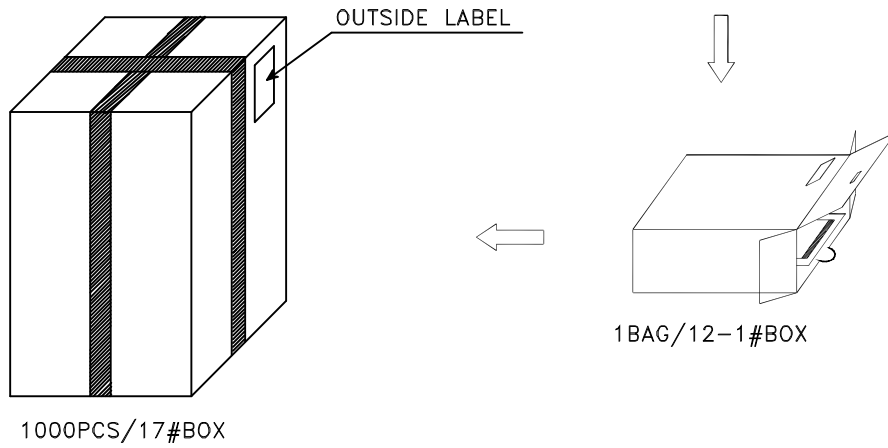
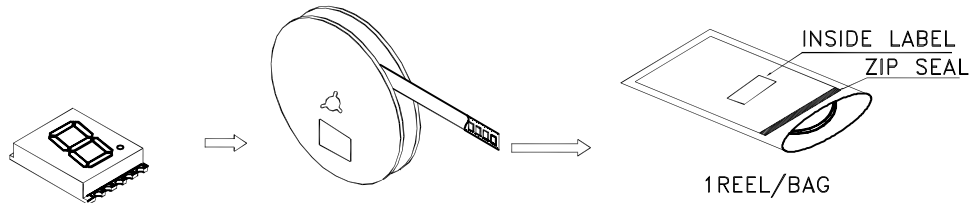

All design applications should refer to Kingbright application notes available at <http://www.KingbrightUSA.com/ApplicationNotes>