

Automotive Power Common Mode Chokes

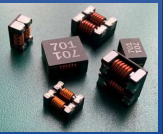

ACMP-Q7040

Request Samples



Check Inventory



7.0 x 6.0 x 3.8 mm
RoHS/RoHS II Compliant
MSL Level = 1

Features

- AEC-Q200 compliant, Grade 1
- PPAP ready and supported
- Manufactured in TS/IATF 16949 production lines
- Excellent impedance characteristics
- Rated current up to 15A
- Extremely low DCR

Applications

- DC power line common mode noise suppression.
- Multimedia devices
- Automotive power train
- Automotive infotainment

Electrical Specifications

Part Number	Impedance (Ω) @100MHz		DCR (m Ω)	Rated Current (A)	Rated Voltage (Vdc)	Insulation Resistance (M Ω)
	Min	Typ.	Max	Max	Max	Min
ACMP-Q7040-700	40	70	5	15	80	10
ACMP-Q7040-141	100	140	10	9	80	10
ACMP-Q7040-301	225	300	10	5	80	10
ACMP-Q7040-501	400	500	10	5	80	10
ACMP-Q7040-701	500	700	15	4	80	10
ACMP-Q7040-102	800	1020	17	3	80	10
ACMP-Q7040-132	910	1300	20	3	80	10

Rated Current is based on an Irms temperature rise of 40°C.

ACMP-Q7040 is AEC-Q200 Automotive certified.

ACMP-Q7040 Series is RoHS Compliant and Pb free.

Operating Temperature: -40°C to +125°C. (Including self-heating)

Storage Temperature (on PCB): -40°C to +125°C.

Storage (in original packaging): <40°C, <60% RH.



5101 Hidden Creek Ln, Spicewood TX 78669
Phone: 512-371-6159 Fax: 512-351-8858
For terms and conditions of sales, please visit:
www.abracon.com

REVISION A 8/24/2023

ABRACON IS
ISO9001-2015
CERTIFIED

Automotive Power Common Mode Chokes

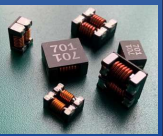

ACMP-Q7040

Request Samples



Check Inventory



7.0 x 6.0 x 3.8 mm
 RoHS/RoHS II Compliant
 MSL Level = 1

ACMP-Q7040-700

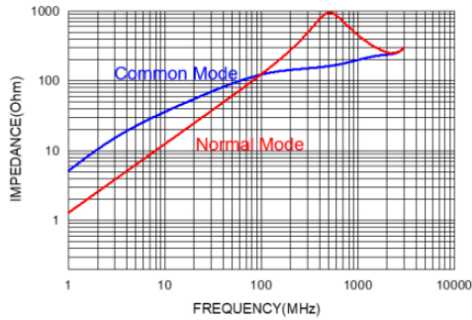

ACMP-Q7040-141

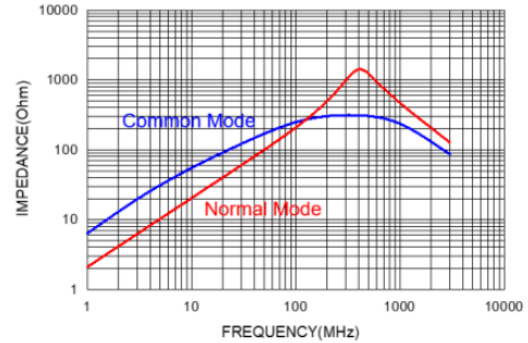

ACMP-Q7040-301

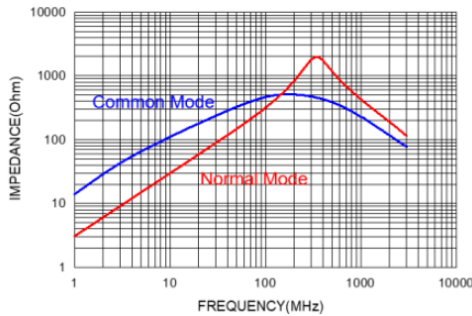

ACMP-Q7040-501

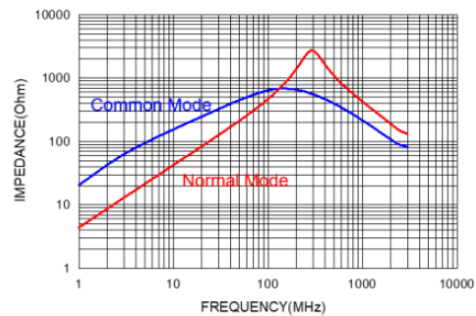

ACMP-Q7040-701

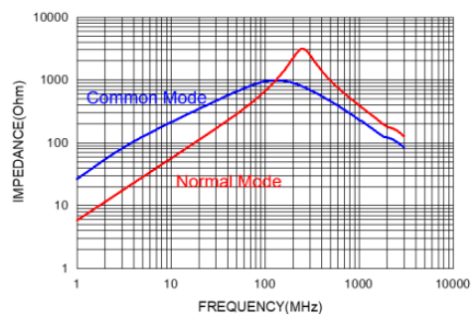

ACMP-Q7040-102

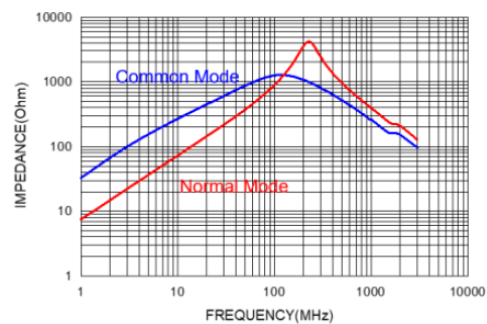

ACMP-Q7040-132

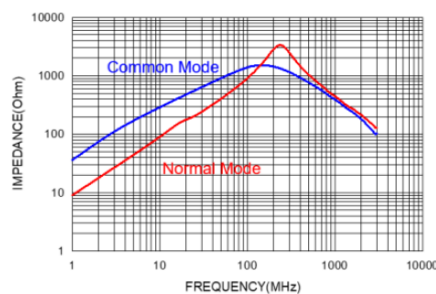

5101 Hidden Creek Ln, Spicewood TX 78669
 Phone: 512-371-6159 Fax: 512-351-8858
 For terms and conditions of sales, please visit:
www.abracon.com

REVISION A 8/24/2023

ABRACON IS
 ISO9001-2015
 CERTIFIED

Automotive Power Common Mode Chokes

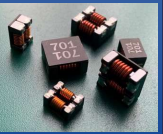

ACMP-Q7040

Request Samples



Check Inventory



7.0 x 6.0 x 3.8 mm
RoHS/RoHS II Compliant
 MSL Level = 1

Mechanical Specifications

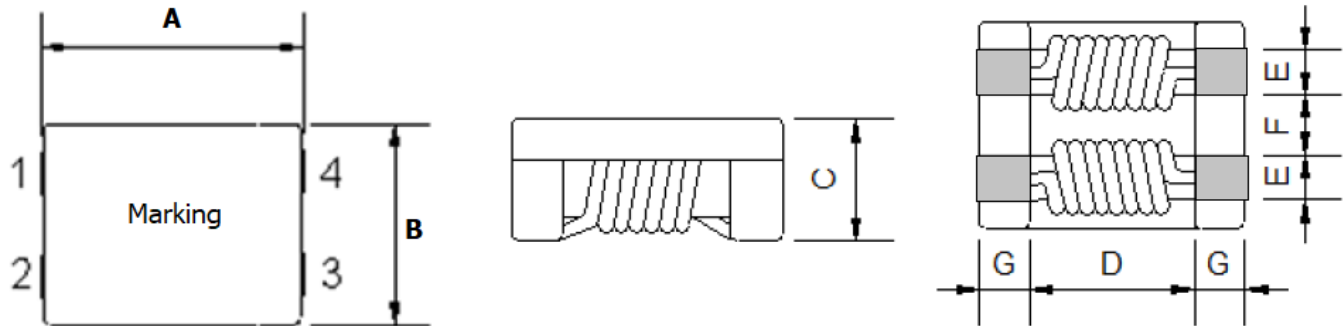

A	B	C	D	E	F	G
7.0 ±0.5	6.0 ±0.5	3.8 MAX	3.5 Typ.	1.5 ±0.5	1.5 ±0.5	1.7 ±0.2

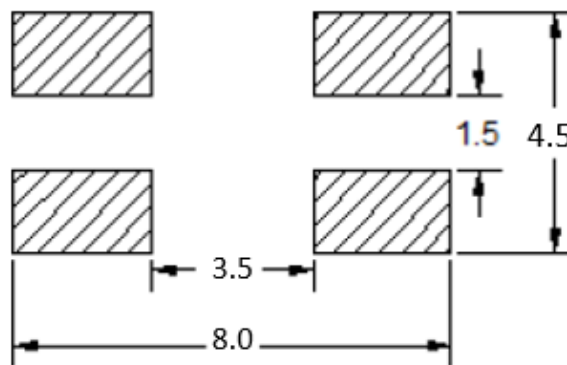

Recommended Layout

Dimensions: mm

Automotive Power Common Mode Chokes

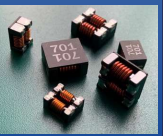

ACMP-Q7040

Request Samples



Check Inventory



7.0 x 6.0 x 3.8 mm
RoHS/RoHS II Compliant
 MSL Level = 1

Schematic

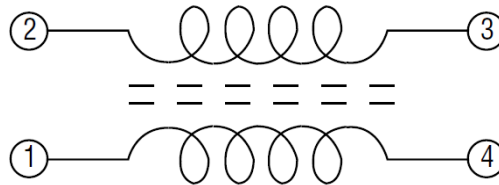

Materials

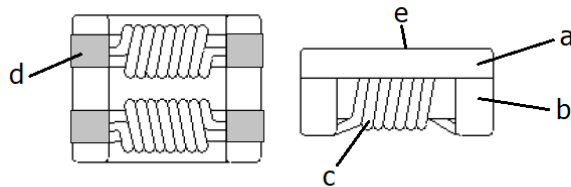

	Description	Specification
a	Upper Plate	Plastic
b	Core	Ferrite Core
c	Wire	Enameled Copper
d	Electrode	Ag/Ni/Sn + Sn Solder
e	Marking	Laser Marking

Part Identification

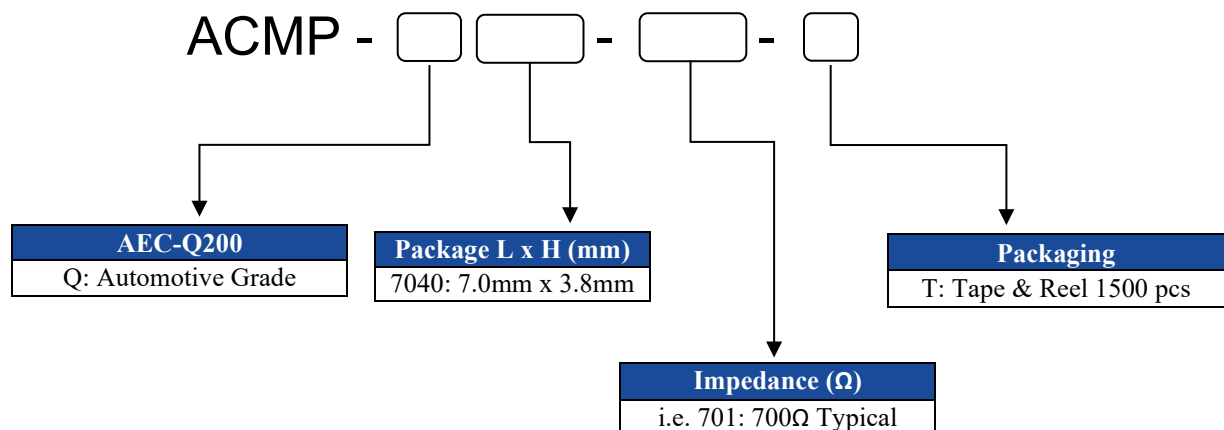

Automotive Power Common Mode Chokes

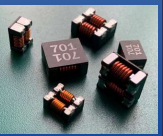

ACMP-Q7040

Request Samples



Check Inventory



7.0 x 6.0 x 3.8 mm
RoHS/RoHS II Compliant
 MSL Level = 1

Reflow Profile

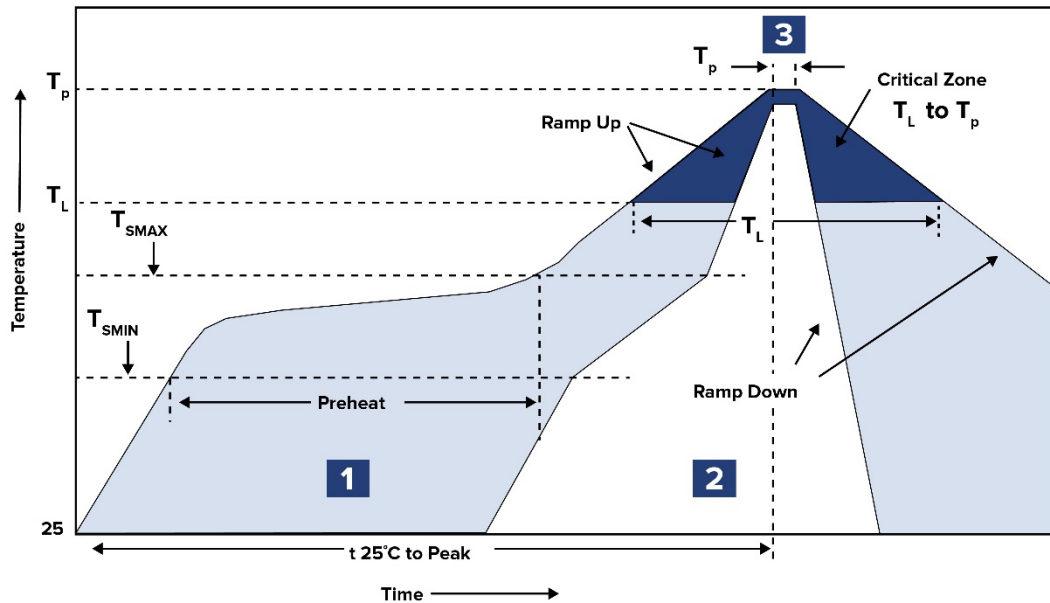

Zone	Description	Temperature	Times
1	Preheat	$T_{SMIN} \sim T_{SMAX}$ 150°C ~ 200°C	60 ~ 120 sec.
2	Reflow	T_L 217°C	60 ~ 150 sec.
3	Peak heat	T_P 250°C ± 5°C	30 sec. MAX

Automotive Power Common Mode Chokes

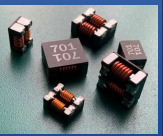

ACMP-Q7040

Request Samples



Check Inventory



7.0 x 6.0 x 3.8 mm
RoHS/RoHS II Compliant
 MSL Level = 1

Packaging

Tape & Reel: 1500pcs/reel

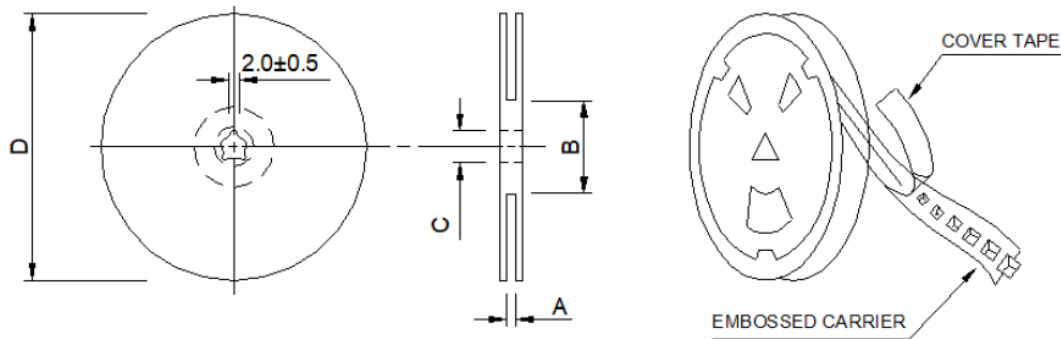

Series	A	B	C	D
ACMP-Q7040	16.0 ±0.5	100.0 ±2.0	13.5 ±0.5	330

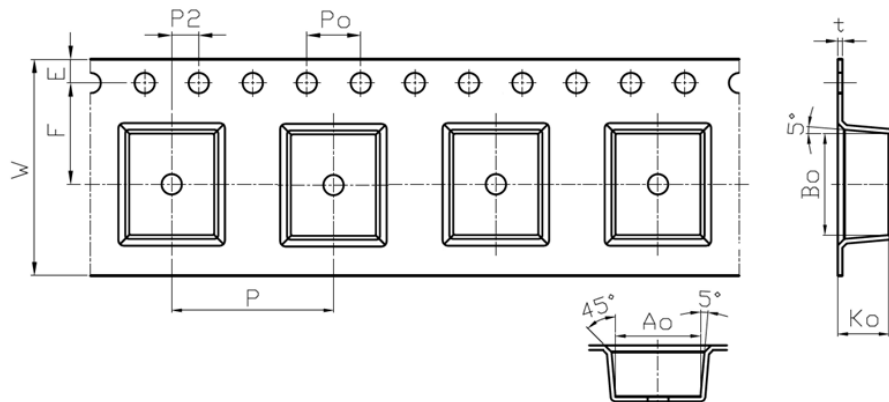

W	P	E	F	P0	P2	Bo	Ao	Ko	t
16.0 ±0.30	12 ±0.10	1.75 ±0.10	7.5 ±0.10	4.0 ±0.10	2.0 ±0.10	7.5 ±0.10	6.3 ±0.10	3.8 ±0.10	0.35 ±0.05

Dimensions: mm

ATTENTION: Abracon LLC's products are COTS – Commercial-Off-The-Shelf products; suitable for Commercial, Industrial and, where designated, Automotive Applications. Abracon's products are not specifically designed for Military, Aviation, Aerospace, Life-dependent Medical applications or any application requiring high reliability where component failure could result in loss of life and/or property. For applications requiring high reliability and/or presenting an extreme operating environment, written consent and authorization from Abracon LLC is required. Please contact Abracon LLC for more information.



5101 Hidden Creek Ln, Spicewood TX 78669
 Phone: 512-371-6159 Fax: 512-351-8858
 For terms and conditions of sales, please visit:
www.abracon.com

REVISION A 8/24/2023

ABRACON IS
 ISO9001-2015
 CERTIFIED