

UWB: 3.7 – 4.2 GHz Chip Antenna



ACG0502U

Request Samples



Check Inventory



5.2 x 2.0 x 1.0mm
RoHS Compliant
MSL Level = 1

Features

- BW of 500 MHz
- Linear Polarization
- VSWR <2.0
- Extended Operating Temperature of -40/+105 °C

Applications

- UWB (Ultra-Wide Band)
- IoT
- M2M
- Secure car access
- Item Tracking
- Indoor Navigation
- Hands-Free Payment
- Smart Access
- Object Detection

Product Image



UWB: 3.7 – 4.2 GHz Chip Antenna



ACG0502U

Request Samples



Check Inventory



5.2 x 2.0 x 1.0mm
RoHS Compliant
MSL Level = 1

Electrical Specification

Parameter	Min	Typ	Max	Unit	Notes
Operating Frequency	3700	-----	4200	MHz	-----
Band Width	-----	500	-----	MHz	-----
VSWR	-----	-----	2.0	-----	-----
Polarization	Linear			-----	-----
Azimuth Beam width	Omni-directional			-----	-----
Impedance	-----	50	-----	Ω	-----

Mechanical Specification

Parameter	Specifications
Filter Dimension	5.2 x 2.0 x 1.0 mm
Mounting Type	SMD Mount
Material Type	Ceramic

Environmental Specification

Parameter	Specifications
Operating Temperature Range	-40°C ~ +105°C
Storage Temperature Range	-30°C ~ +105°C
MSL level	1
ESD	N/A
Relative Humidity range	90~95%

UWB: 3.7 – 4.2 GHz Chip Antenna



ACG0502U

Request Samples



Check Inventory



5.2 x 2.0 x 1.0mm
RoHS Compliant
 MSL Level = 1

Package Dimension



(Top View)

Number	Terminal Name
①	INPUT
②	NC

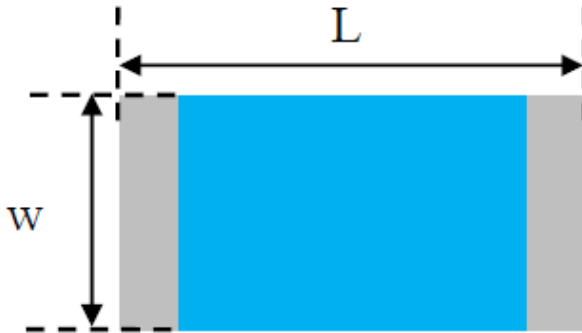

(Bottom View)



(Side View)



(Side View)

Symbol	L	W	T	A
Dimension (mm)	5.2±0.2	2.0±0.2	1.0±0.1	0.5±0.1

UWB: 3.7 – 4.2 GHz Chip Antenna



ACG0502U

Request Samples



Check Inventory



5.2 x 2.0 x 1.0mm
RoHS Compliant
MSL Level = 1

Footprint

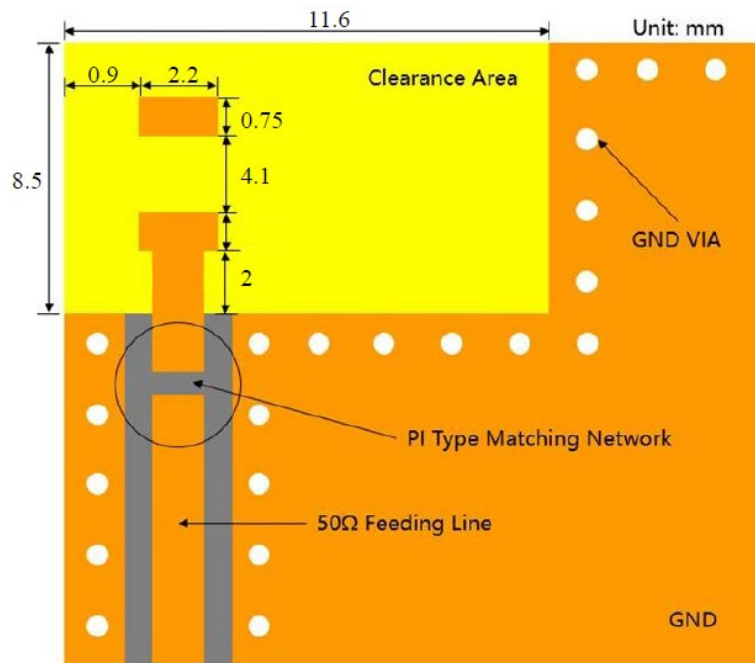

Evaluation Board Dimension

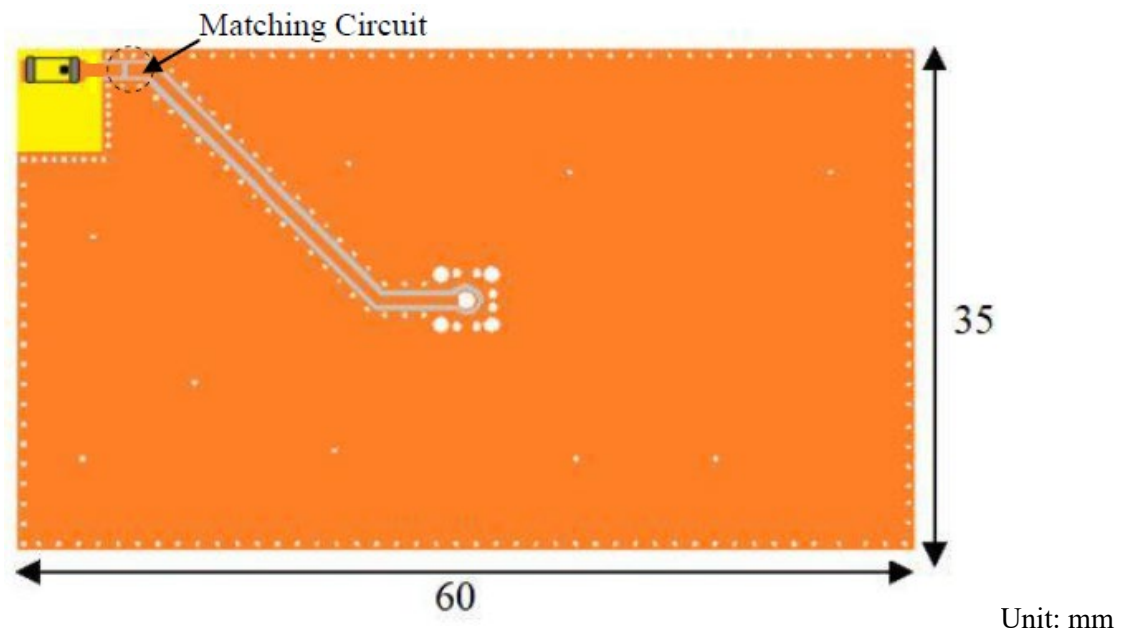

UWB: 3.7 – 4.2 GHz Chip Antenna



ACG0502U

Request Samples



Check Inventory



5.2 x 2.0 x 1.0mm
RoHS Compliant
MSL Level = 1

Measurement Setup

The antenna measurements were all performed in free space with the antenna mounted on its evaluation board of size 36 x 61 mm, see image below.



UWB: 3.7 – 4.2 GHz Chip Antenna



ACG0502U

Request Samples



Check Inventory



5.2 x 2.0 x 1.0mm
RoHS Compliant
MSL Level = 1

Impedance Characteristics – Return Loss

The (dashed) vertical lines mark the frequency span for UWB channel 2 (3.74 to 4.24 GHz).

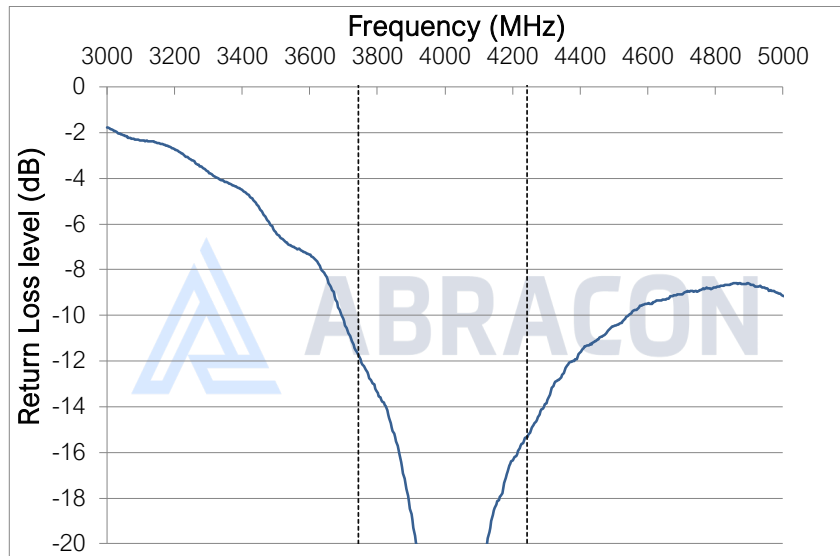

Radiation Characteristics – Total Efficiency

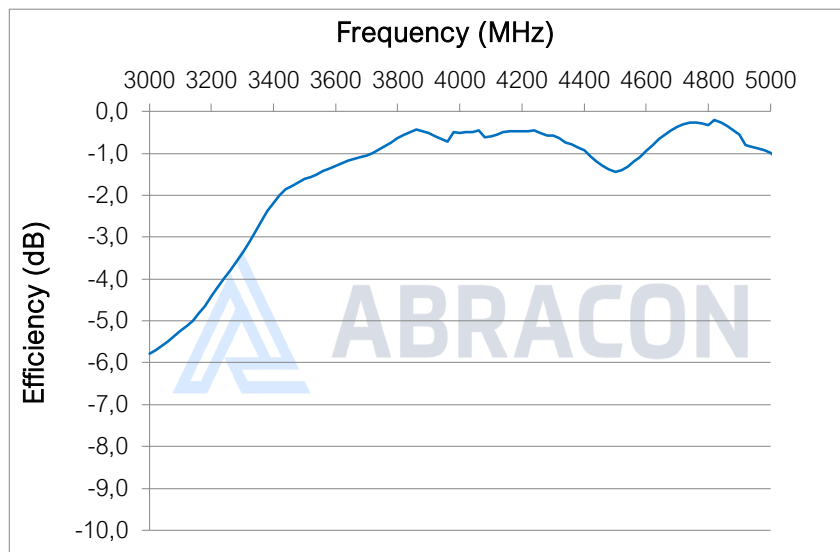

UWB: 3.7 – 4.2 GHz Chip Antenna



ACG0502U

Request Samples



Check Inventory



5.2 x 2.0 x 1.0mm
RoHS Compliant
MSL Level = 1

Radiation Characteristics – Maximum Gain

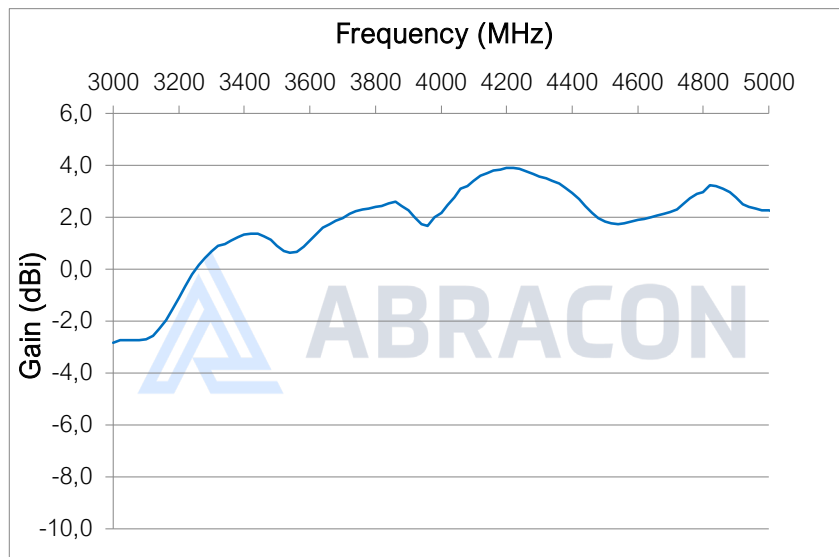

Radiation Characteristics – Group Delay

Two identical antennas were placed a distance d_{sep} apart in an anechoic chamber. The Group Delay, τ_{GD} , is then calculated from the transmission S-parameter (S12) by $\tau_{GD} = -\frac{1}{2 \cdot 360} \frac{\Delta\phi}{\Delta f}$, where $\Delta\phi$ is the change of phase over an aperture Δf . The maximum variation in group delay per channel, $\Delta_{max}\tau_{GD}$, can be found in the table below.

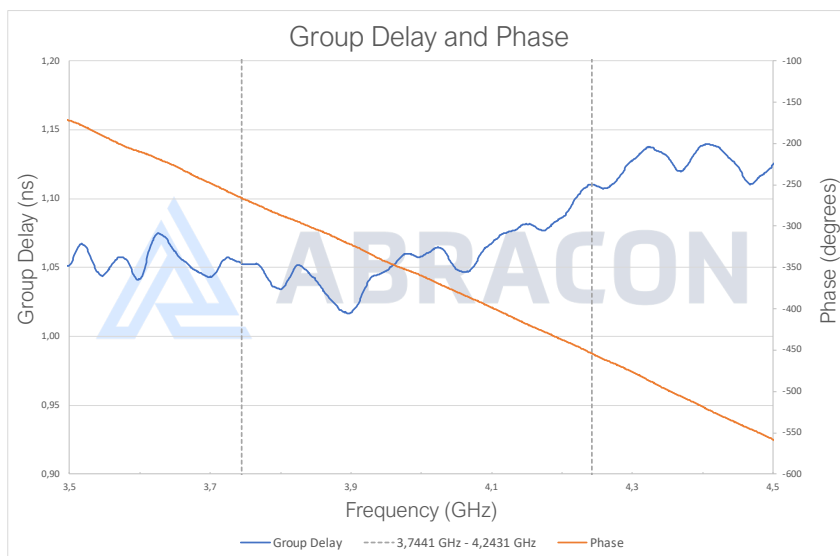

Maximum Group Delay Variation			
UWB Ch.	Freq. Low (GHz)	Freq. High (GHz)	$\Delta_{max}\tau_{GD}$ (ps)
2	3,744	4,2432	93

Used Parameters	
Distance d_{sep} (cm)	Aperture Δf (MHz)
50	220



5101 Hidden Creek Ln Spicewood TX 78669
Phone: 512-371-6159 | Fax: 512-351-8858
For terms and conditions of sales, please visit:
www.abracon.com

REVISED: 09-21-22

ABRACON IS
ISO9001-2015
CERTIFIED

UWB: 3.7 – 4.2 GHz Chip Antenna



ACG0502U

Request Samples



Check Inventory



5.2 x 2.0 x 1.0mm
RoHS Compliant
MSL Level = 1

Radiation Characteristics – 2D Pattern (3.74 GHz)

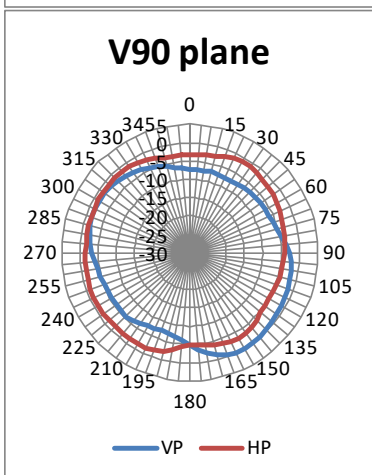
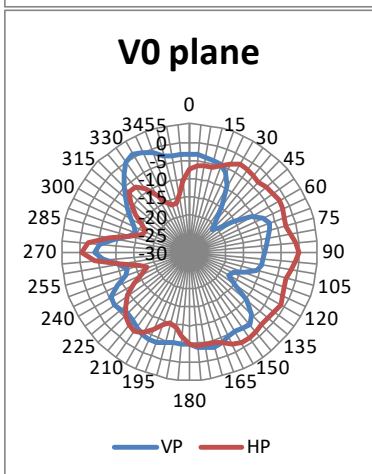
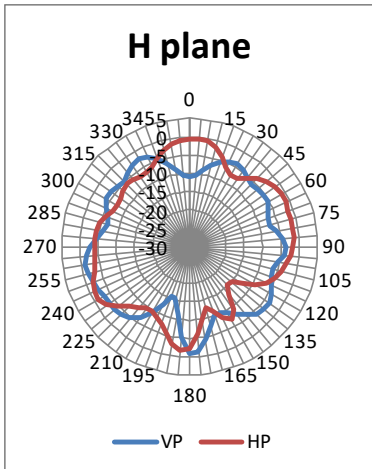

VP: Vertical Polarization
HP: Horizontal Polarization

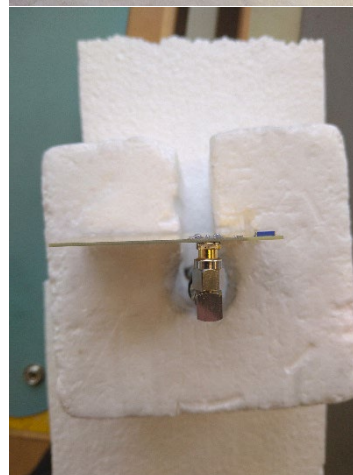
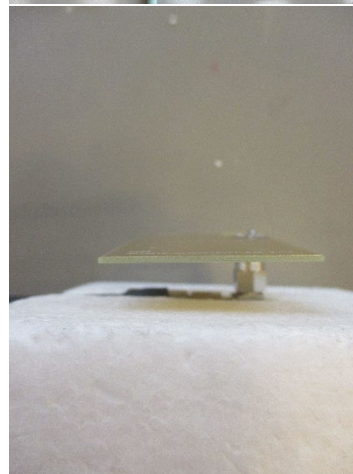
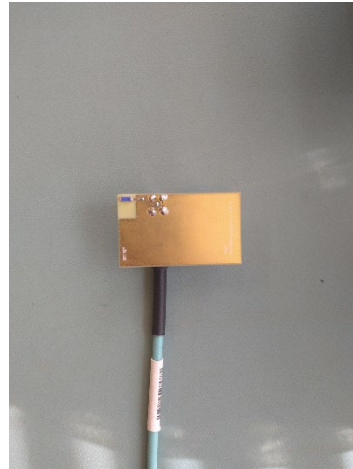

Unit: dBi

UWB: 3.7 – 4.2 GHz Chip Antenna



ACG0502U

Request Samples



Check Inventory



5.2 x 2.0 x 1.0mm
RoHS Compliant
MSL Level = 1

Radiation Characteristics – 2D Pattern (4.24 GHz)

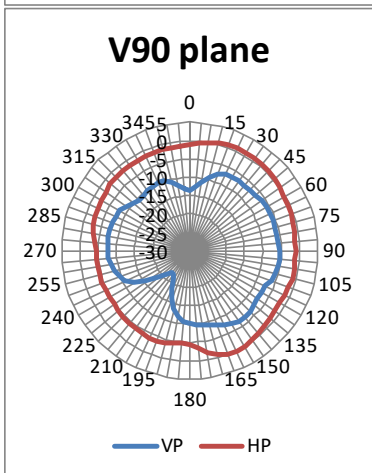
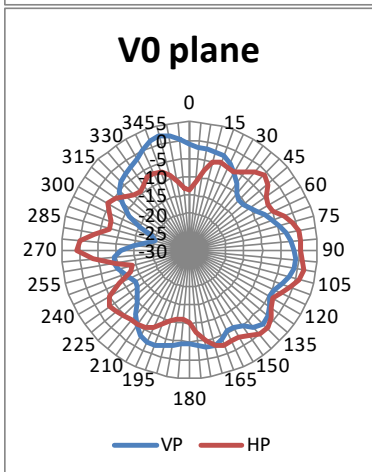
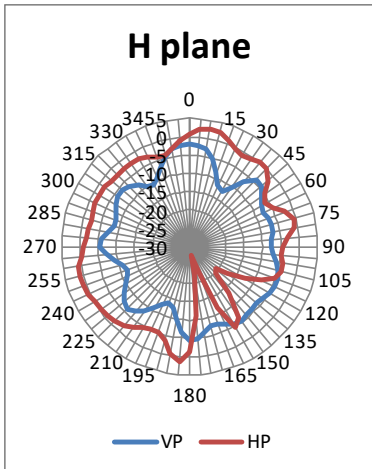

VP: Vertical Polarization
HP: Horizontal Polarization

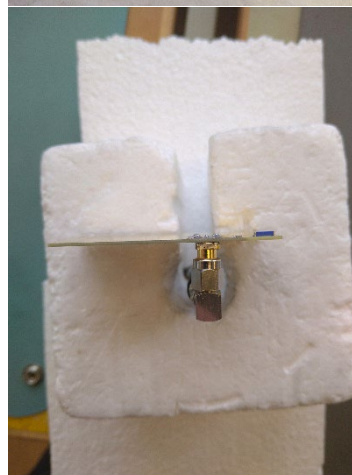
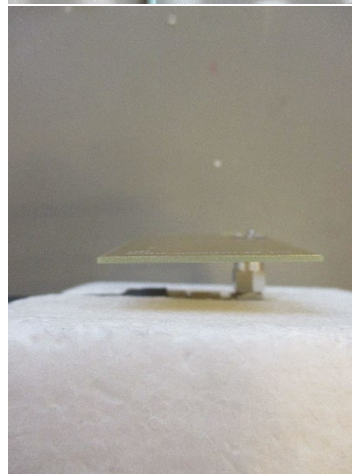
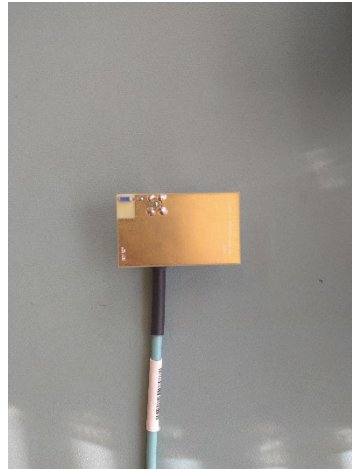

Unit: dBi

UWB: 3.7 – 4.2 GHz Chip Antenna



ACG0502U

Request Samples



Check Inventory



5.2 x 2.0 x 1.0mm
RoHS Compliant
MSL Level = 1

Soldering Profile: Reflow

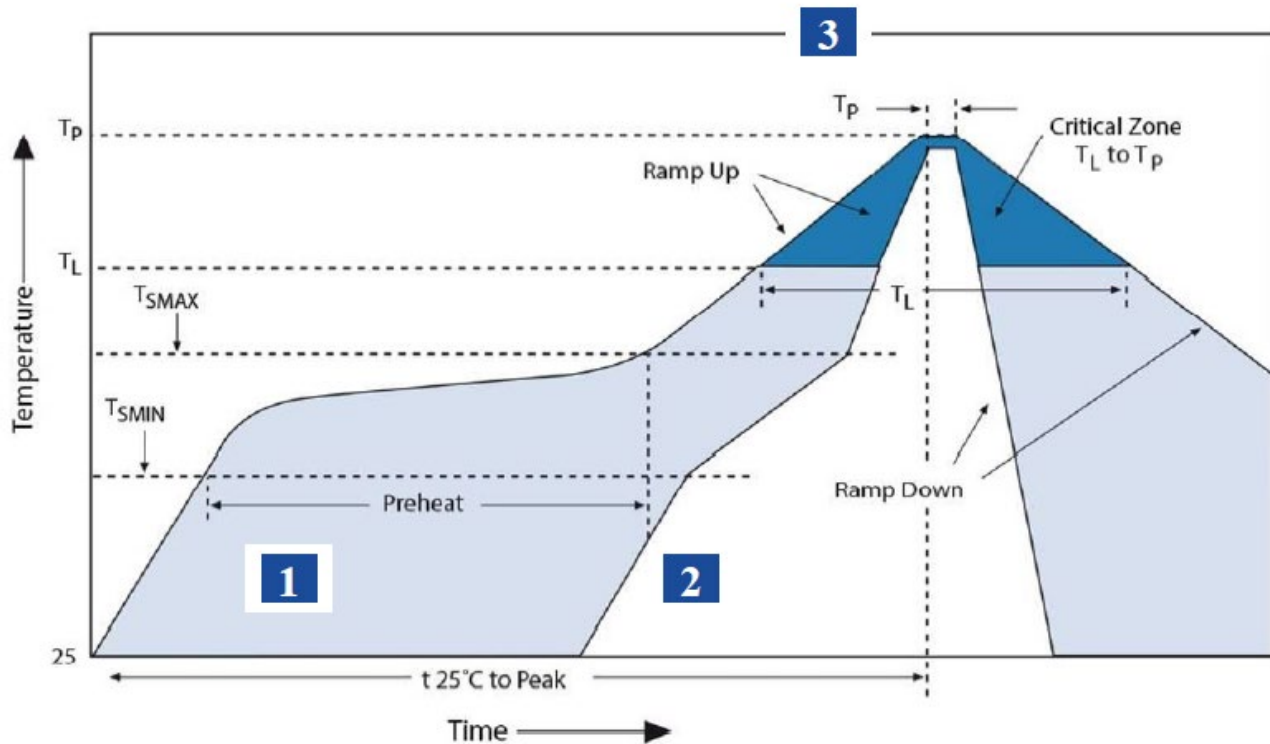

Zone	Description	Temperature	Time
1	Preheat / Soak	$T_{SMIN} \sim T_{SMAX}$ 160 – 180 °C	60 ~ 120 sec
2	Reflow	T_L 220 °C	60~80 sec
3	Peak heat	T_P 265 °C	5 sec (Max)

UWB: 3.7 – 4.2 GHz Chip Antenna



ACG0502U

Request Samples



Check Inventory



5.2 x 2.0 x 1.0mm
RoHS Compliant
MSL Level = 1

Packaging and Dimensions

1. Plastic Tape

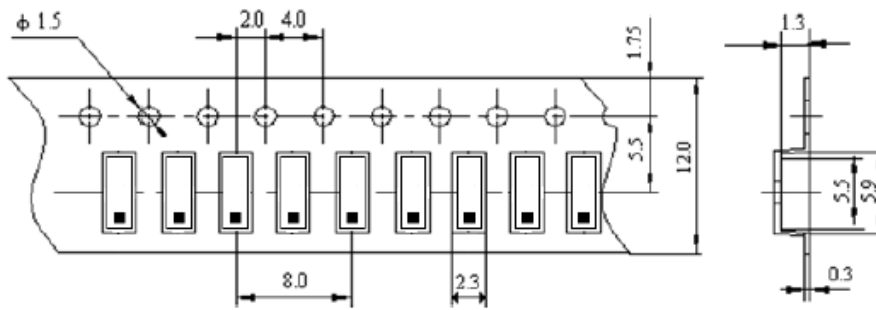

Reserve a length of 150~200mm for the trailer of the carrier and 250~300 mm for the leader of the carrier and further 250mm of cover tape at the leading part of the carrier.

2. Reel (3000 pcs/Reel)

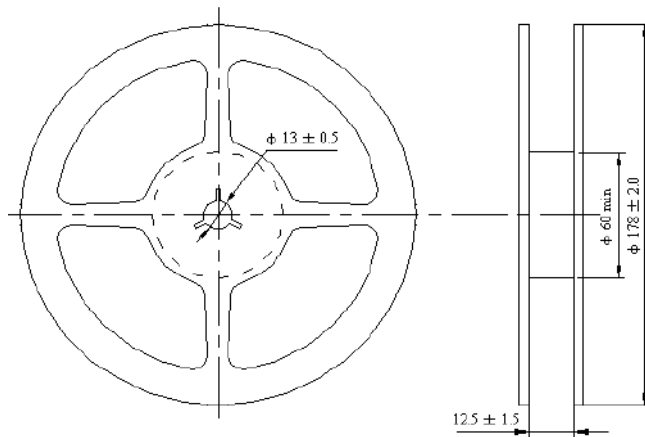

Unit : mm

ATTENTION: Abracon LLC's products are COTS – Commercial-Off-The-Shelf products; suitable for Commercial, Industrial and, where designated, Automotive Applications. Abracon's products are not specifically designed for Military, Aviation, Aerospace, Life-dependent Medical applications or any application requiring high reliability where component failure could result in loss of life and/or property. For applications requiring high reliability and/or presenting an extreme operating environment, written consent and authorization from Abracon LLC is required. Please contact Abracon LLC for more information.



5101 Hidden Creek Ln Spicewood TX 78669
Phone: 512-371-6159 | Fax: 512-351-8858
For terms and conditions of sales, please visit:
www.abracon.com

REVISED: 09-21-22

ABRACON IS
ISO9001-2015
CERTIFIED