

CABC Compatible, Ambient Light Control Boost LED Backlight Driver and Four LDOs

General Description

The AAT2893 family is a highly-integrated lighting management unit (LMU) optimized for single-cell lithium-ion/polymer battery powered systems and is ideal for portable devices.

The AAT2893 integrates a high voltage DC/DC boost converter and an internally programmed over-voltage protection circuit. It drives 10 LEDs (or more) in series¹ controlled by a high precision, 128-step current sink, programmable up to 28.6mA. The high frequency PWM dimming implementation is compliant with Content Adaptive Brightness Control (CABC) specification with a PWM frequency up to 100kHz. The ambient light sensor (ALS) management function features automatic sensor calibration, enabling system designers to use low cost photo diodes, and 50Hz/60Hz noise rejection for accurate brightness adjustment without processor intervention. The AAT2893 also contains four high-performance, low-noise and low dropout (LDO) linear regulators. Each regulator starts up with a default 1.2V and is adjustable by programming through the I²C interface. LDOA can supply up to 300mA, while LDOB, C and D can source up to 150mA to a system load.

All AAT2893 functions are programmed using an industry standard bi-directional I²C interface.

The AAT2893 is available in a Pb-free, space saving 2.0mm x 2.5mm, 20-ball CSP package rated over a -40°C to +85°C temperature range.

Features

WLED Driver

- 1.3MHz Switching Frequency
- Over-voltage Protection
 - AAT2893-1 up to 42V
 - AAT2893-2 up to 33V
- Automatic Soft Start
- Programmable Backlight Current
 - 28.6mA Maximum Current
 - 128 Levels (7-bit): 0 – 28.6mA
 - Programmable Fade-in and Fade-out
- Advanced Dimming Features
 - Ambient Light Sensor Management
 - Direct Ambient Dimming Function
 - 128 Programmable Levels
 - CABC Compatible PWM Dimming

Four Linear Regulators

- LDOA up to 300mA
 - LDOB, LDOC and LDOD up to 150mA
 - 150mV Dropout
 - I²C Programmable Outputs: 1.2V to 3.3V
 - Output Auto-Discharge for Fast Shutdown
- Input Voltage Range: 3.0V to 5.5V
 - Built-In Over-temperature Protection
 - Industry Standard I²C Programming Interface
 - -40°C to 85°C Temperature Range
 - 2.0mm x 2.5mm, 20 Ball, 0.4mm Pitch CSP Package

Applications

- Camera Enabled Mobile Devices
- Digital Still Cameras
- Multimedia Mobile Phones

Part Number	I ² C Address ²	Over-voltage Protection Level (V)
AAT2893-1	60h	42
AAT2893-2	60h	33

1. The actual number of series LEDs depends on OVP and V_F of WLED.
 2. Other I²C addresses available, contact factory.

AAT2893

CABC Compatible, Ambient Light Control Boost LED Backlight Driver and Four LDOs

Typical Application Circuit

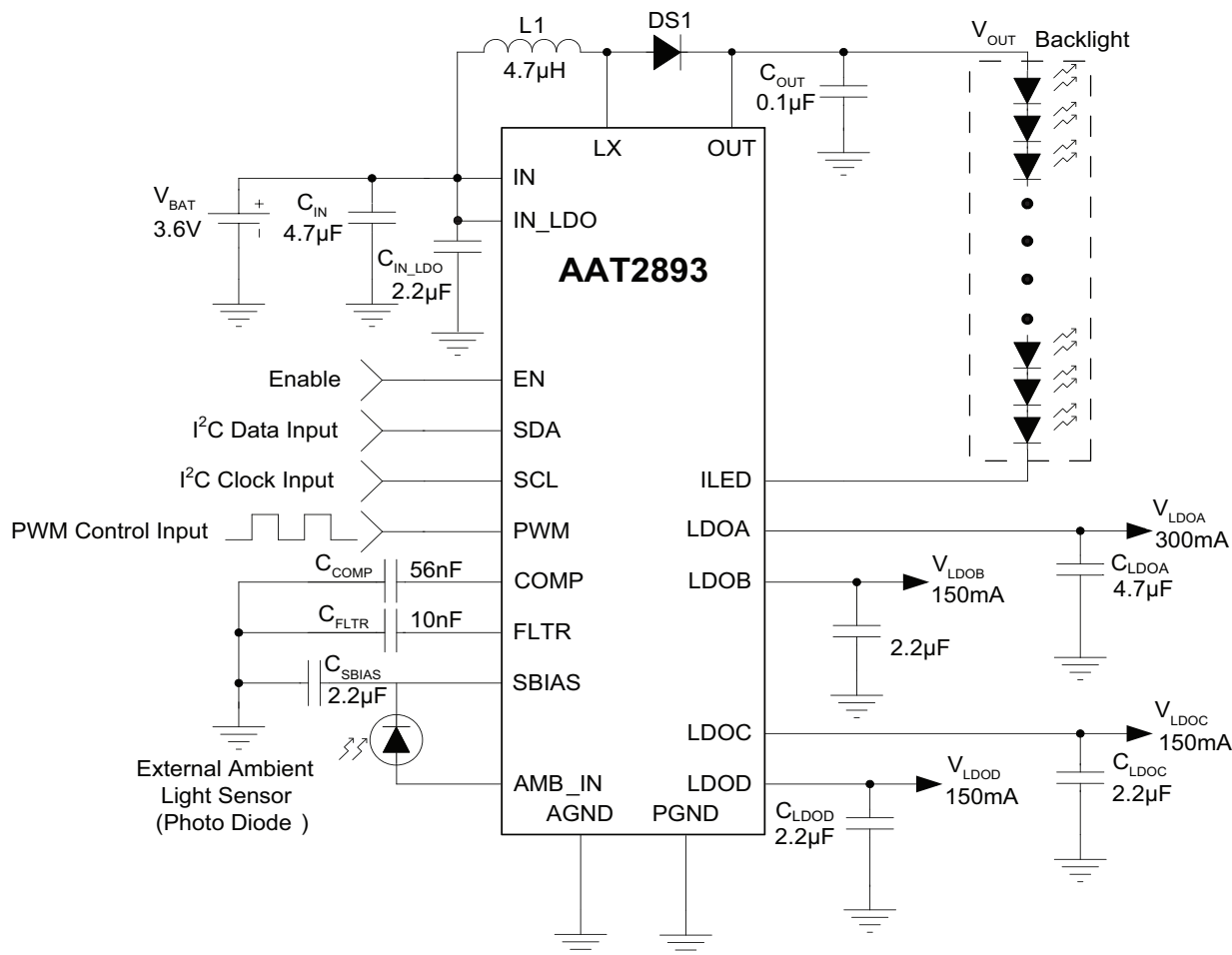

CABC Compatible, Ambient Light Control Boost LED Backlight Driver and Four LDOs**Pin Descriptions**

Pin #	Symbol	Description
A1	LDOD	LDOD regulated voltage output pin. Bypass LDOD to AGND with a 2.2μF or larger capacitor as close to the AAT2893 as possible.
A2	LDOC	LDOC regulated voltage output pin. Bypass LDOC to AGND with a 2.2μF or larger capacitor as close to the AAT2893 as possible.
A3	LDOB	LDOB regulated voltage output pin. Bypass LDOB to AGND with a 2.2μF or greater capacitor as close to the AAT2893 as possible.
A4	LDOA	LDOA regulated voltage output pin. Bypass LDOA to AGND with a 4.7μF or larger ceramic capacitor as close to the AAT2893 as possible.
B1	IN_LDO	Input power supply pin for all four LDO voltage regulators. Bypass IN_LDO to PGND with a 2.2μF or larger ceramic capacitor located as close to the AAT2893 as possible.
B2	IN	Power input. Connect IN to the input source voltage. Bypass IN to PGND with a 4.7μF or larger ceramic capacitor as close to the AAT2893 as possible.
B3	EN	Enable Pin. Drive high to enable, low to shutdown.
B4	SBIAS	Ambient light sensor bias supply output. This pin provides a regulated bias supply to the attached ambient light sensor.
C1	AGND	Analog ground. Connect AGND to PGND at a single point as close to the AAT2893 as possible.
C2	DGND	Digital ground. Connect AGND and DGND and PGND at a single point as close to the AAT2893 as possible.
C3	SCL	I ² C Serial Clock input pin
C4	AMB_IN	Ambient light sensor input connection pin. Connect the photo diode anode or ambient light sensor module output to this pin.
D1	PGND	Power ground. Connect AGND to PGND at a single point as close to the AAT2893 as possible.
D2	PWM	Content controlled backlight brightness PWM signal input pin. Pull high to disable the PWM dimming feature.
D3	SDA	I ² C Serial Data pin, this pin is bi-directional.
D4	FLTR	PWM input filter capacitor pin. Connect a 10nF ceramic capacitor between this pin and AGND.
E1	LX	Boost converter switching node. Connect an inductor between this node and IN.
E2	OUT	Boost converter output, place an external schottky between this node and LX
E3	ILED	Series LED string current sink. ILED controls the current through backlight LED constant current sink. Connect to the cathode of the last LED in the LED string.
E4	COMP	Compensation pin. Connect a capacitor via this pin to GND. Compensation components are mainly related to the output capacitor value.

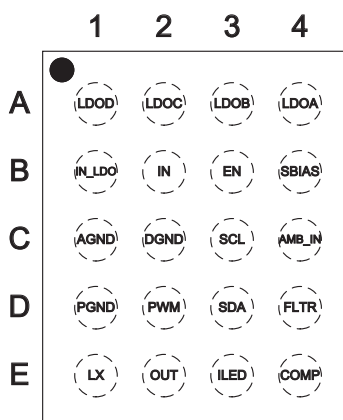
Pin Configurations**2.0mm × 2.5mm, 4 × 5 Ball Array CSP
(Top View)**

AAT2893**CABC Compatible, Ambient Light Control Boost LED Backlight Driver and Four LDOs****Absolute Maximum Ratings¹**

Symbol	Description	Value	Units	
V_{IN}, V_{IN_LDO}	Input Voltage to AGND, PGND	-0.3 to 6	V	
$V_{LX}, V_{ILED}, V_{OUT}$	High Voltage to AGND, PGND	AAT2893-1		-0.3 to 50
		AAT2893-2		-0.3 to 44
EN, SDA, SCL, COMP, PWM, FLTR, SBIAS, LDOA, LDOB, LDOC, LDOD	Pin Voltage to AGND, PGND	-0.3 to $V_{IN}+0.3$		
V_{AMB-IN}	Ambient Light Sensor Maximum Input Voltage to AGND, PGND	V_{IN}		

Thermal Information²

Symbol	Description	Value	Units
Θ_{JA}	Thermal Resistance ³	79	°C/W
P_D	Maximum Power Dissipation	1.26	W
T_J	Operating Junction Temperature Range	-40 to 150	°C
T_{LEAD}	Maximum Soldering Temperature (at Leads, 10s)	300	

Recommended Operating Conditions

Symbol	Description	Value			Units
		Min	Typ	Max	
V_{IN}	Input Supply Voltage	3.0		5.5	V
V_{OUT}	Boost Converter Output Voltage	$V_{IN}+3V$		V_{OVP_T}	
L1	Inductor Value	4.7	10	22	μH
f_{PWM-F}	Filtered PWM Input Frequency	0.1		100	kHz
T_A	Ambient Operating Temperature	-40	25	85	°C

1. Stresses above those listed in Absolute Maximum Ratings may cause permanent damage to the device. Functional operation at conditions other than the operating conditions specified is not implied.

2. Mounted on a FR4 circuit board.

3. Derate 12.6mW/°C above 25°C ambient temperature.

CABC Compatible, Ambient Light Control Boost LED Backlight Driver and Four LDOs**Electrical Characteristics¹**

$V_{IN} = 3.6V$; $C_{IN} = 4.7\mu F$; $C_{COMP} = 56nF$; $C_{OUT} = C_{SBIAS} = 2.2\mu F$; $L = 4.7\mu H$; $T_A = -40^{\circ}C$ to $+85^{\circ}C$, unless otherwise noted. Typical values are $T_A = 25^{\circ}C$.

Symbol	Description	Conditions	Min	Typ	Max	Units	
V_{IN}	Boost Converter Input Operating Voltage Range		3.0		5.5	V	
I_{QIN}	IN Operating Current Standby / No Load	$EN = V_{IN}$; $I_{LED} = OFF$ via I ² C		400		μA	
$I_{QIN(SW)}$	IN Operating Current (Switching)	$EN = V_{IN}$; No Load / $I_{LED} = ON$			2.3	mA	
$I_{IN(SHDN)}$	IN Shutdown Current	$EN = 0$; $I_{LED} = OFF$ via I ² C			1.0	μA	
T_{SD}	Over-temperature Shutdown Threshold			150		$^{\circ}C$	
$T_{SD(HYS)}$	Over-Temperature Shutdown Hysteresis				15		
D_{MIN}	Minimum PWM dimming Duty Cycle			8		%	
DC/DC Boost Section							
$R_{DS(ON)}$	Switch On-Resistance	$T_A = 25^{\circ}C$		650		m Ω	
η	Maximum Efficiency	$L1 = 10\mu H$, $I_{OUT} = 28.6mA$, $V_{OUT} = 36V$		82		%	
f_{OSC}	Switching Frequency	$T_A = 25^{\circ}C$	1.17	1.3	1.43	MHz	
t_{SS}	Soft-start Time	$T_A = 25^{\circ}C$		4		ms	
D_{MAX}	Maximum Duty Cycle		94			%	
I_{L_LIMIT}	Inductor Current Limit			800		mA	
V_{OVP_T}	OUT Over Voltage Protection Threshold	V_{OVP} Rising	AAT2893-1	38	42	45	V
			AAT2893-2	30.4	33	36	
V_{OVPH}	Over Voltage Protection Hysteresis	AAT2893-1		2.8		V	
		AAT2893-2		2.2			
ILED Driver							
I_{ILED}	I_{LED} Current Accuracy	$V_{IN} - V_F = 1V$, Set $I_{LED} = 19.8mA$ by I ² C	17.8	19.8	21.79	mA	
		$V_{IN} - V_F = 1V$, Set $I_{LED} = 2.03mA$ by I ² C	1.62	2.03	2.43	mA	
t_{FADE}	I_{LED} Automatic Fade In/Out Timer	$V_{IN} - V_F = 1V$	0.75	1	1.25	s	
Ambient Light Sensor Interface							
V_{SBIAS}	Ambient Light Sensor Bias Voltage Output Tolerance	Set $V_{SBIAS} = 3.0V$ by I ² C, $I_{SBIAS} = 200\mu A$	2.85	3.0	3.15	V	
		Set $V_{SBIAS} = 2.6V$ by I ² C, $I_{SBIAS} = 200\mu A$	2.47	2.60	2.73		
$I_{OUT(SBIAS)[MAX]}$	SBIAS Maximum Output Current		30			mA	
$V_{ALS(FS)}$	Ambient Light Sensor Full Scale Input Voltage		1.6			V	
$I_{IN(ALS)[MAX]}$	ALS ADC maximum input current				1	μA	
$R_{OUT(SBIAS)[DCHG]}$	SBIAS Auto-Discharge Resistance			1		k Ω	

1. The AAT2893 is guaranteed to meet performance specifications over the $-40^{\circ}C$ to $+85^{\circ}C$ operating temperature range and is assured by design, characterization, and correlation with statistical process controls.

2. Current matching is defined as the deviation of any sink current from the average of all active channels.

3. $V_{DO[A/B/C/D]}$ is defined as $V_{IN} - LDO[A/B/C/D]$ when $LDO[A/B/C/D]$ is 98% of nominal.

CABC Compatible, Ambient Light Control Boost LED Backlight Driver and Four LDOs**Electrical Characteristics (continued)¹**

$V_{IN} = 3.6V$; $C_{IN} = 4.7\mu F$; $C_{COMP} = 56nF$; $C_{OUT} = C_{SBIAS} = 2.2\mu F$; $L = 4.7\mu H$; $T_A = -40^{\circ}C$ to $+85^{\circ}C$, unless otherwise noted. Typical values are $T_A = 25^{\circ}C$.

Symbol	Description	Conditions	Min	Typ	Max	Units
Linear Regulators						
V_{IN_LDO}	LDO Regulator Input Supply		$V_{OUT} + V_{DO}$		5.5	V
$\frac{\Delta V_{OUT[A/B/C/D]}}{V_{OUT[A/B/C/D]}}$	LDOA, LDOB, LDOC, LDOD Output Voltage Tolerance	$I_{OUT} = 1mA$ to $150mA$; $T_A = 25^{\circ}C$	-2		2	%
		$I_{OUT} = 1mA$ to $150mA$; $T_A = -40^{\circ}C$ to $+85^{\circ}C$	-3.0		3.0	
$I_{OUT[A](MAX)}$	LDOA Maximum Load Current		300			mA
$V_{OUT[A](DO)}$	LDOA Dropout Voltage ³	$V_{OUT[A]} \geq 3.0V$; $I_{OUT} = 300mA$		200		mV
$I_{OUT[B/C/D](MAX)}$	LDOB, LDOC, LDOD Maximum Load Current		150			mA
$V_{OUT[B/C/D](DO)}$	LDOB, LDOC, LDOD Dropout Voltage ³	$V_{OUT[B/C/D]} \geq 3.0V$; $I_{OUT} = 150mA$		150		mV
$\frac{\Delta V_{OUT}}{(V_{OUT} \cdot \Delta V_{IN})}$	Line Regulation	$V_{IN} = (V_{OUT[A/B/C/D]} + 1V)$ to $5V$		0.09		%/V
$PSRR_{[A/B/C/D]}$	LDOA, LDOB, LDOC, LDOD Power Supply Rejection Ratio	$I_{OUT[A/B/C/D]} = 10mA$, $1kHz$		50		dB
$R_{OUT_D(CHG)}$	LDOA, LDOB, LDOC, LDOD Auto-Discharge Resistance			1		k Ω
Input Threshold Levels - EN, PWM						
$V_{TH(L)}$	Input Low Threshold				0.4	V
$V_{TH(H)}$	Input High Threshold		1.4			
I²C Logic and Control Interface						
V_{IL}	SDA, SCL, EN Input Low Threshold	$3.0V \leq V_{IN} \leq 5.5V$			0.4	V
V_{IH}	SDA, SCL, EN Input High Threshold	$3.0V \leq V_{IN} \leq 5.5V$	1.4			
V_{OL}	SDA Output Low Voltage	$I_{PULLUP} = 3mA$			0.4	
I_{IN}	SDA, SCL, EN Input Leakage Current	$V_{SDA} = V_{SCL}$	-1		1	μA
f_{SCL}	SCL Clock Frequency		0		400	kHz
t_{LOW}	SCL Clock Low Period		1.3			μs
t_{HIGH}	SCL Clock High Period		0.6			
t_{HD_STA}	Hold Time START Condition		0.6			
t_{SU_DAT}	SDA Data Setup Time		100			ns
t_{HD_DAT}	SDA Data HOLD Time		0		0.9	μs
t_{SU_STO}	Setup Time for STOP Condition		0.6			
t_{BUF}	Bus Free Time Between STOP and START Conditions		1.3			

1. The AAT2893 is guaranteed to meet performance specifications over the $-40^{\circ}C$ to $+85^{\circ}C$ operating temperature range and is assured by design, characterization, and correlation with statistical process controls.

AAT2893

CABC Compatible, Ambient Light Control Boost LED Backlight Driver and Four LDOs

I²C Interface Timing Details

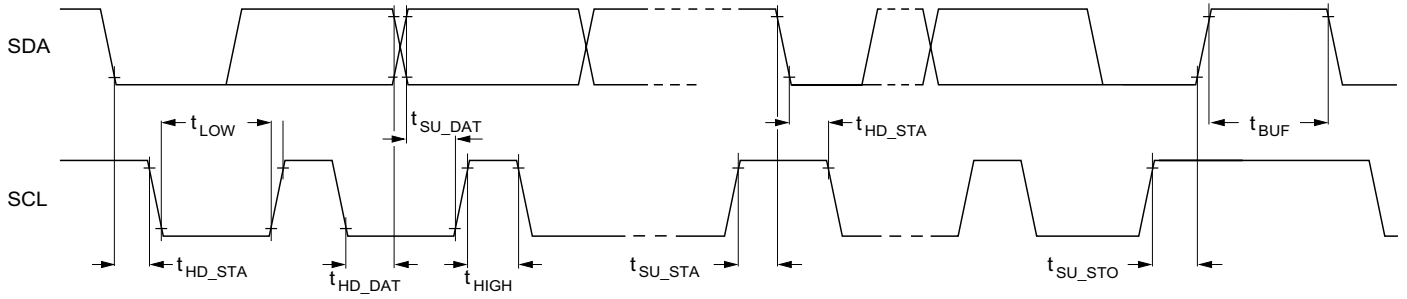

AAT2893

CABC Compatible, Ambient Light Control Boost LED Backlight Driver and Four LDOs

Typical Characteristics

I_Q vs Supply Voltage
(LED = OFF, Disable LDO via I²C)

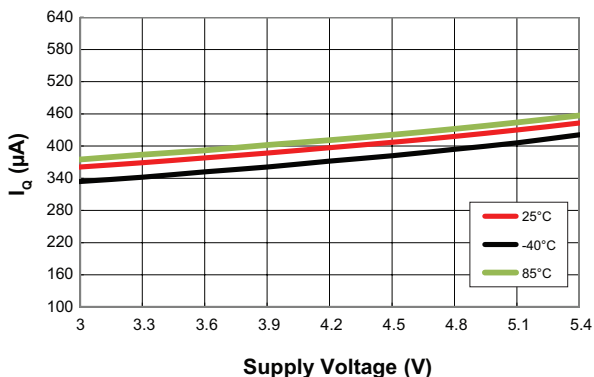

I_Q vs Supply Voltage
(Enable LDO, Disable LED via I²C, I_{LDO} = 0)

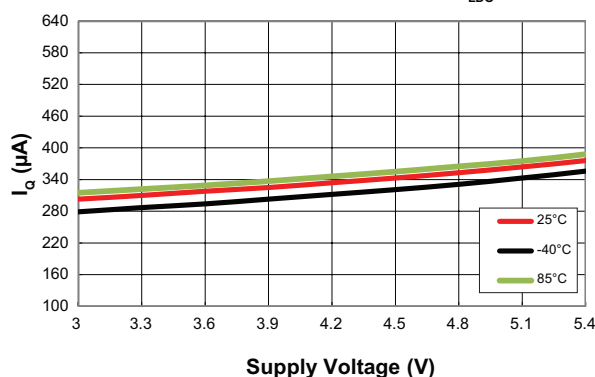

LED Current vs Temperature
(AAT2893-2, V_{IN} = 3.6V, I_{LED} = 28.6mA, 8 WLEDs)

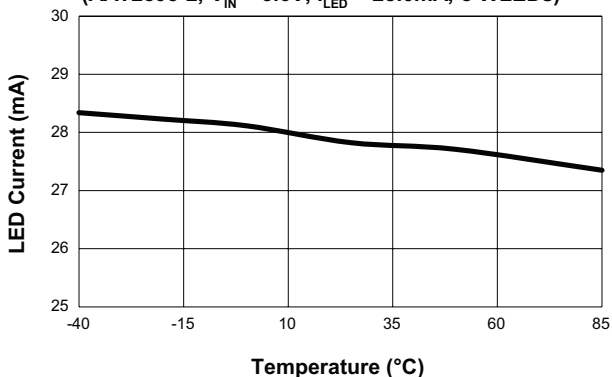

LED Current vs Temperature
(AAT2893-1, V_{IN} = 3.6V, I_{LED} = 28.6mA, 10 WLEDs)

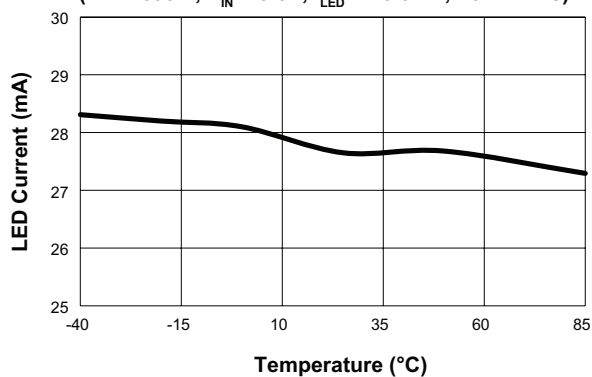

Shutdown Current vs Temperature
(V_{IN} = 3.6V, EN = GND)

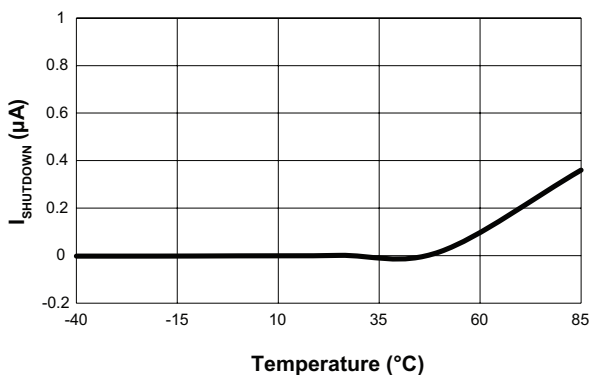

LED Current vs Register (Addr. 00h) Code
(4.7µH, 10 WLEDs)



AAT2893

CABC Compatible, Ambient Light Control Boost LED Backlight Driver and Four LDOs

Typical Characteristics

PWM Duty vs LED Current
(AAT2893-1 10 WLEDs)

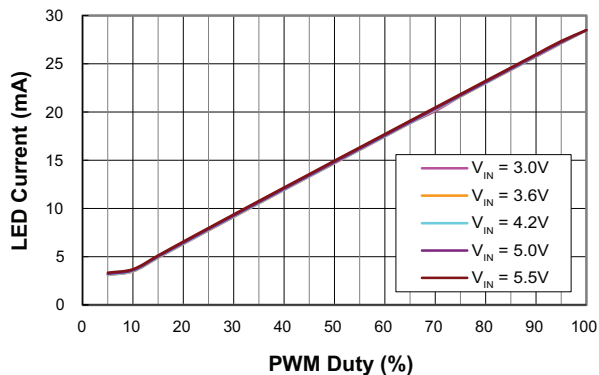

PWM Duty vs LED Current
(AAT2893-2 10 WLEDs)

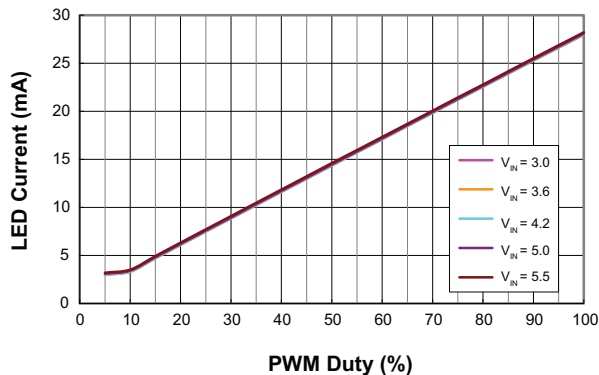

LED Current vs Supply Voltage
(AAT2893-1, $I_{LED} = 28.6\text{mA}$, 10 WLEDs)

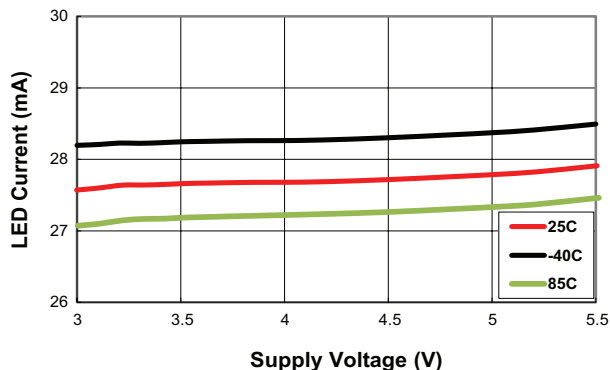

LED Current vs Supply Voltage
(AAT2893-2, $I_{LED} = 28.6\text{mA}$, 8 WLEDs)

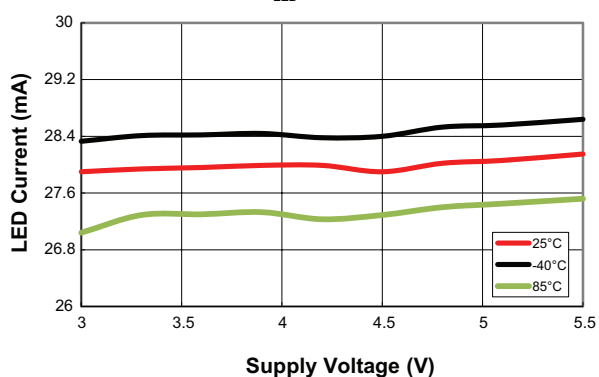

Efficiency vs LED Current
(AAT2893-1, 10 WLEDs)

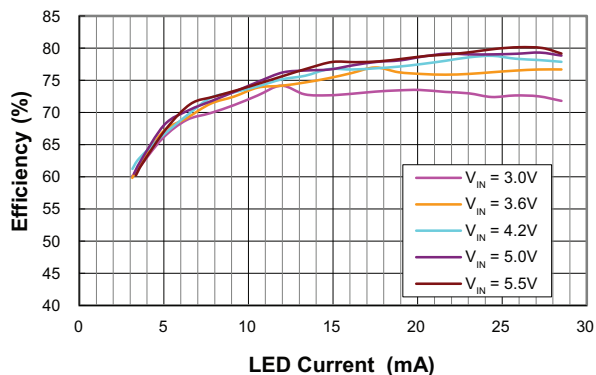

Efficiency vs LED Current
(AAT2893-2, 8 WLEDs)

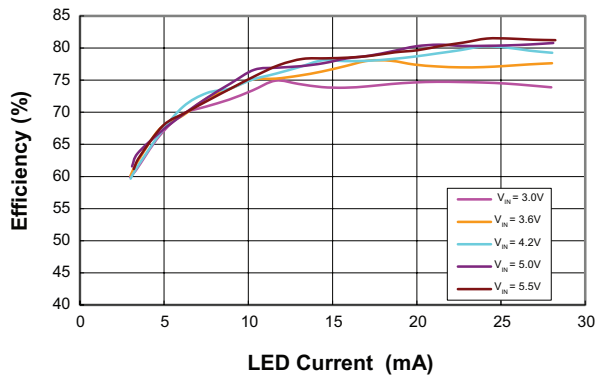

AAT2893

CABC Compatible, Ambient Light Control Boost LED Backlight Driver and Four LDOs

Typical Characteristics

Efficiency vs Register Dimming Code (Addr. 00h)
(4.7μH, 10LEDs)

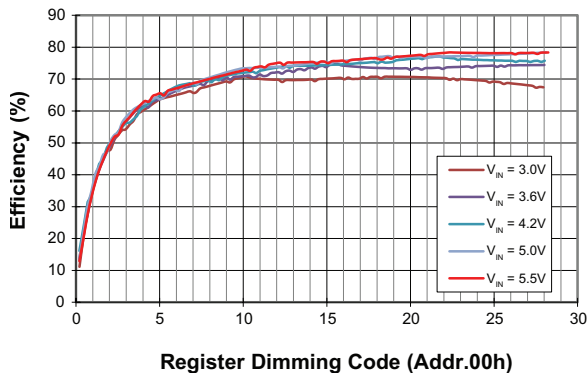

Under-Voltage Lockout Thresholds vs Temperature

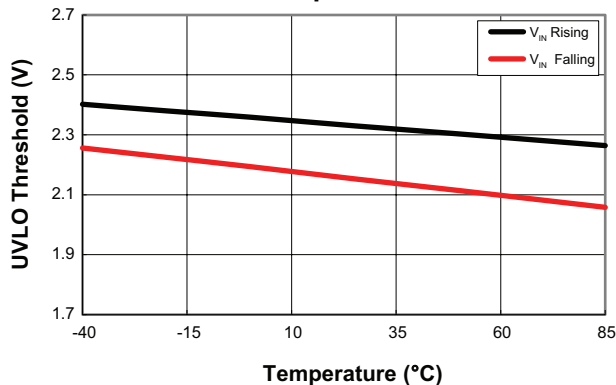

Frequency vs Temperature
(AAT2893-2, V_{IN} = 3.6V, I_{LED} = 28.6mA, 8 WLEDs)

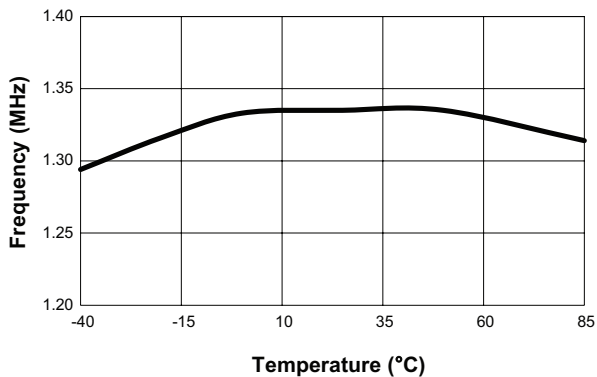

Frequency vs Temperature
(AAT2893-1, V_{IN} = 3.6V, I_{LED} = 28.6mA, 10 WLEDs)

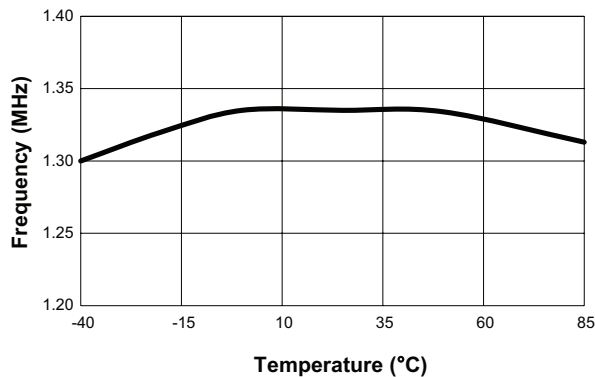

Enable Threshold vs Supply Voltage

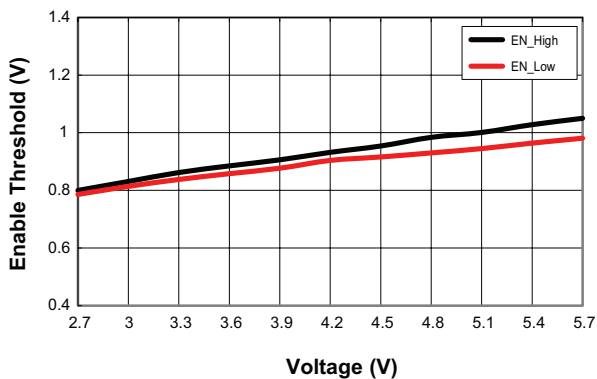

Enable Threshold vs Temperature
(V_{IN} = 3.6V)

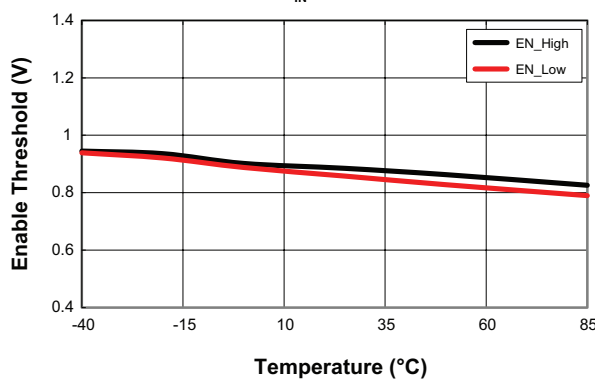

AAT2893

CABC Compatible, Ambient Light Control Boost LED Backlight Driver and Four LDOs

Typical Characteristics

OVP vs Temperature
($V_{IN} = 3.6V$, LED Open)

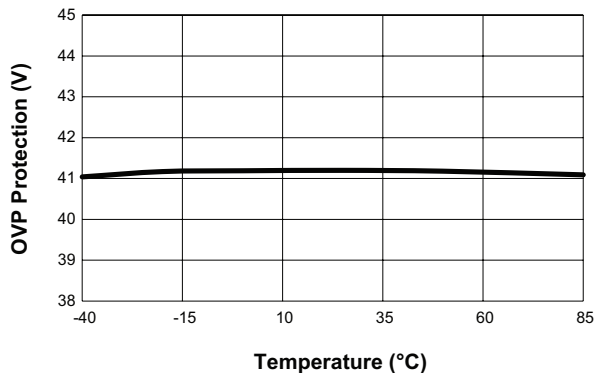

Boost Switch-On Resistance vs Temperature
($V_{IN} = 3.6V$)

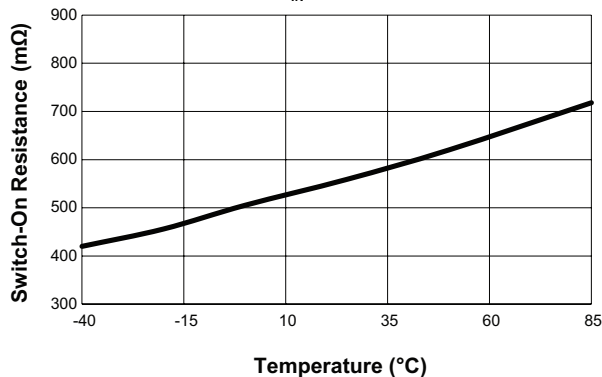

ALS Read Data vs I_{AMB_IN} in Low Gain Mode
(Gain Resistor = 4kΩ, $V_{IN} = 3.6V$)

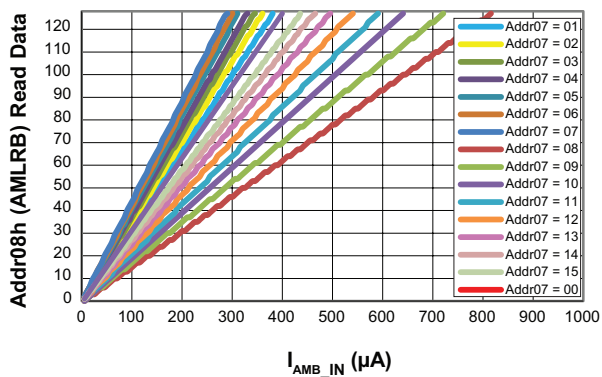

LDOA Dropout Voltage vs Load

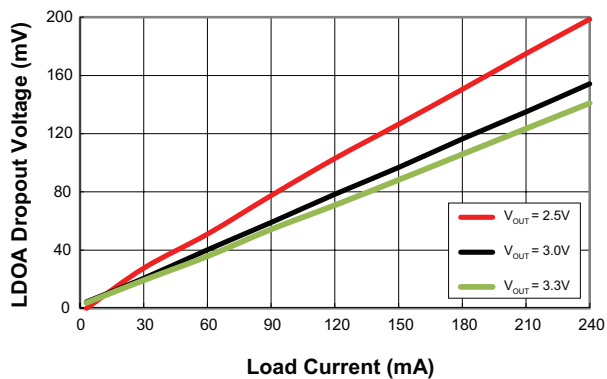

LDOB/C/D Dropout Voltage vs Load

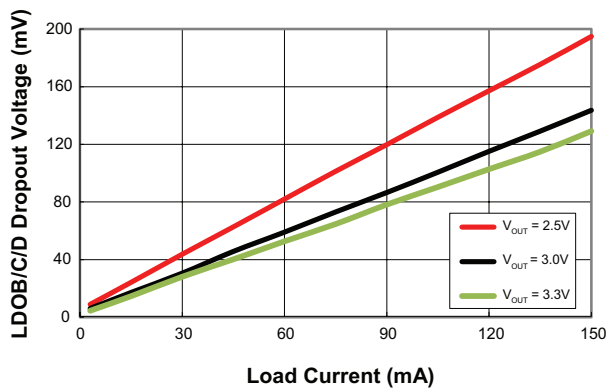

CABC Compatible, Ambient Light Control Boost LED Backlight Driver and Four LDOs

Typical Characteristics

V_{LDOA} Accuracy vs Temperature

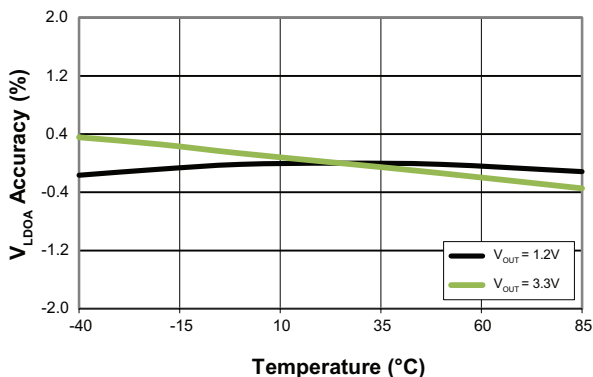

V_{LDOB/C/D} Accuracy vs Temperature

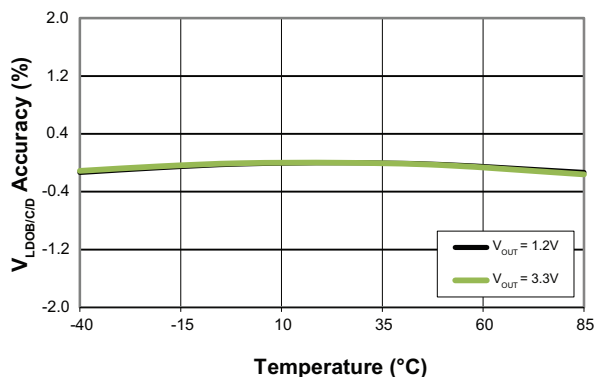

LDOA Output Voltage Load Regulation
(V_{IN} = 3.6V, V_{LDOA} = 1.2V)

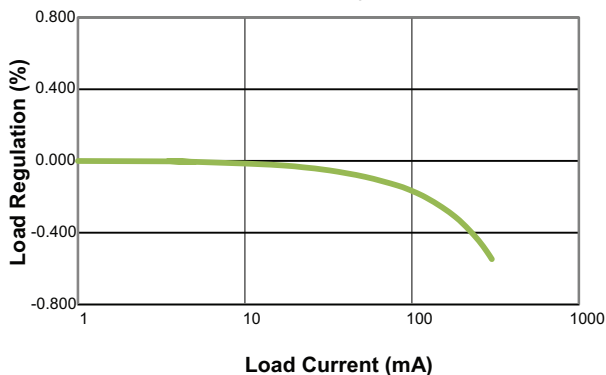

LDOA Output Voltage Load Regulation
(V_{IN} = 3.6V, V_{LDOA} = 3.3V)

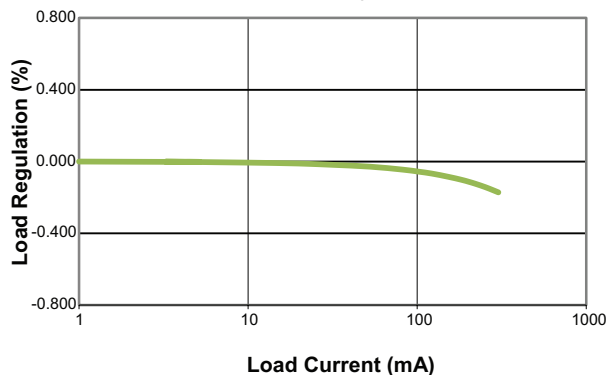

LDOB/C/D Output Voltage Load Regulation
(V_{IN} = 3.6V, V_{LDOB/C/D} = 1.2V)

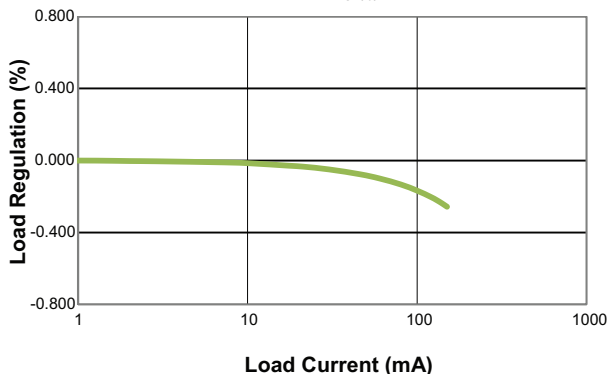

LDOB/C/D Output Voltage Load Regulation
(V_{IN} = 3.6V, V_{LDOB/C/D} = 3.3V)

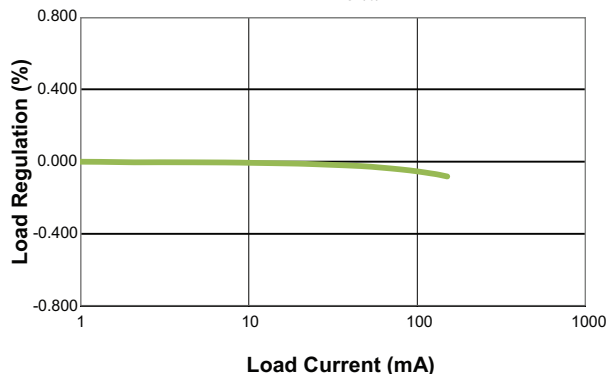

AAT2893

CABC Compatible, Ambient Light Control Boost LED Backlight Driver and Four LDOs

Typical Characteristics

Switching Operation

(AAT2893-2, $V_{IN} = 3.6V$, $I_{LED} = 19.8mA$, 8 WLEDs)



Time (500ns/div)

Switching Operation

(AAT2893-1, $V_{IN} = 3.6V$, $I_{LED} = 19.8mA$, 10 WLEDs)



Time (500ns/div)

OVP

($V_{IN} = 3.6V$, Open LED)

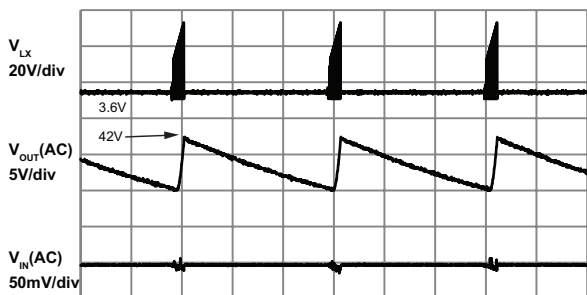

Time (10ms/div)

Boost Start Up

(AAT2893-1, $V_{IN} = 3.6V$, $I_{LED} = 28.6mA$, 10WLEDs)

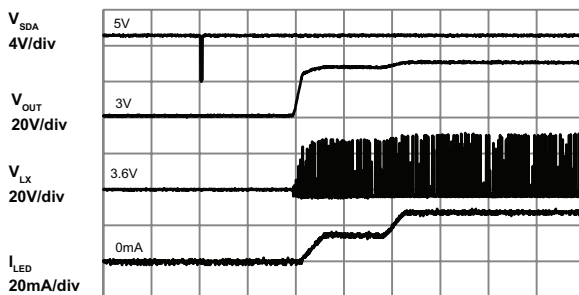

Time (10ms/div)

PWM Dimming Switching

($V_{IN} = 3.6V$, Duty Cycle = 80%, $I_{LED} = 19.8mA$)

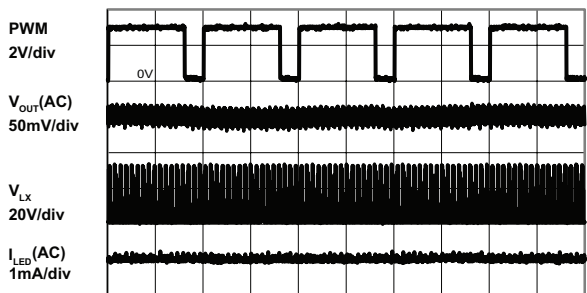

Time (50µs/div)

PWM Dimming Switching

($V_{IN} = 3.6V$, Duty Cycle = 30%, $I_{LED} = 19.8mA$)

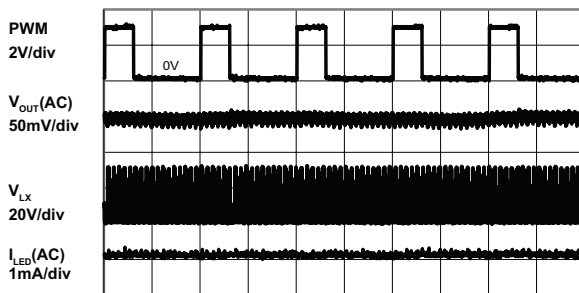

Time (50µs/div)

AAT2893

CABC Compatible, Ambient Light Control Boost LED Backlight Driver and Four LDOs

Typical Characteristics

Fade In Characteristics

(AAT2893-1 $V_{IN} = 3.6V$, $I_{LED} = 18.9mA$, 10 WLEDs, Fade Time = 1s, Fade Floor Current = 0.45mA)

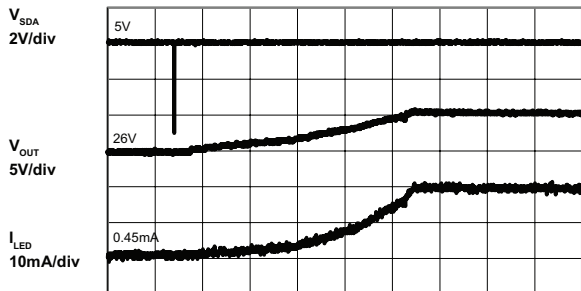

Time (200ms/div)

Fade Out Characteristics

(AAT2893-1 $V_{IN} = 3.6V$, $I_{LED} = 18.9mA$, 10WLEDs, Fade Time = 1s, Fade Floor Current = 0.45mA)

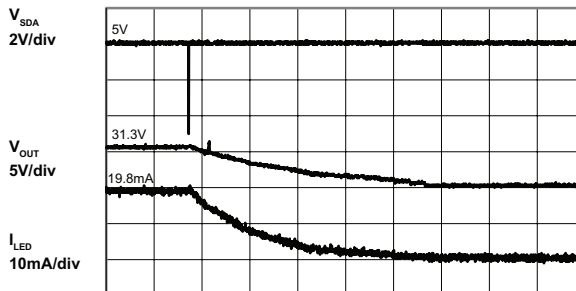

Time (200ms/div)

LDO StartUp

($V_{IN} = 3.6V$, $V_{LDO} = 2.5V$, $I_{LDO} = 20mA$)

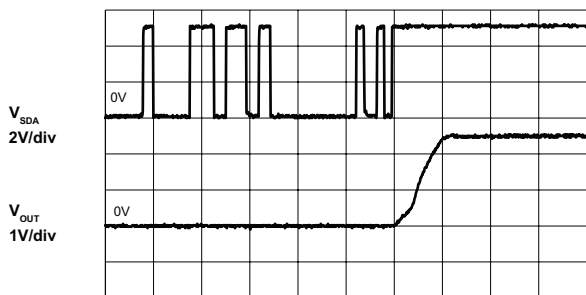

Time (50µs/div)

LDO Output Voltage Change

($V_{IN} = 3.6V$, $I_{LDO} = 20mA$, V_{LDO} convert from 1.2V to 3.3V via I²C)



Time (50µs/div)

LDOA Line Transient

($V_{IN} = 3.6V \sim 5.5V$, $V_{LDOA} = 2.5V$, $I_{LDOA} = 20mA$)



Time (100µs/div)

LDOB/C/D Line Transient

($V_{IN} = 3.6V \sim 5.5V$, $V_{LDOB/C/D} = 2.5V$, $I_{LDOB/C/D} = 20mA$)

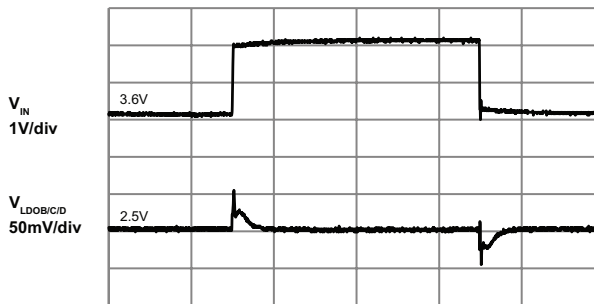

Time (100µs/div)

AAT2893

CABC Compatible, Ambient Light Control Boost LED Backlight Driver and Four LDOs

Typical Characteristics

LDOA Load Transient

($V_{IN} = 3.6V$, $I_{LDOA} = 1mA \sim 300mA$, $V_{LDOA} = 2.5V$)

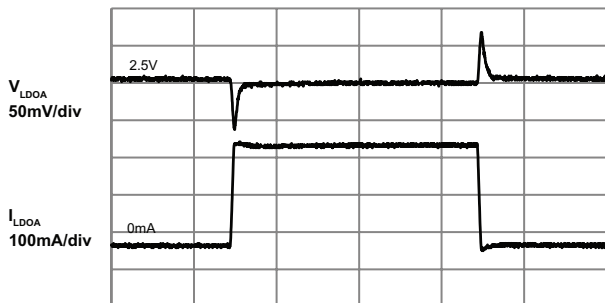

Time (100 μ s/div)

LDOB/C/D Load Transient

($V_{IN} = 3.6V$, $I_{LDOB/C/D} = 1mA \sim 150mA$, $V_{LDOB/C/D} = 2.5V$)

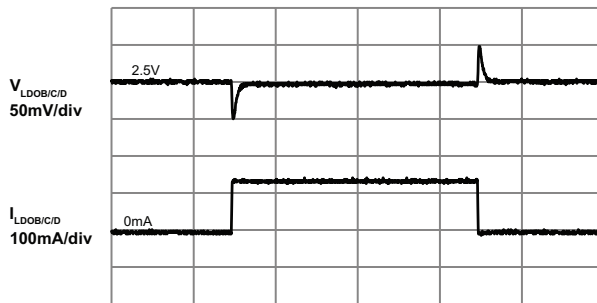

Time (100 μ s/div)

Cross Talk between LDOA and LDOB/C/D

($V_{IN} = 3.6V$, $I_{LDOB/C/D} = 1mA \sim 150mA$, $V_{LDOA} = V_{LDOB/C/D} = 2.5V$)

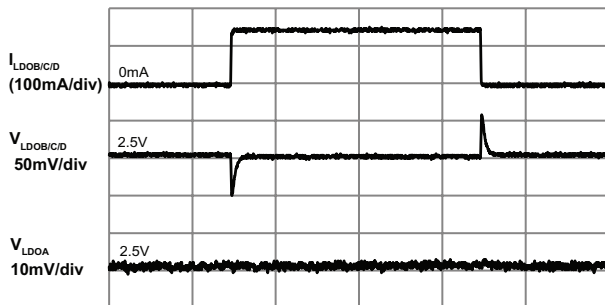

Time (100 μ s/div)

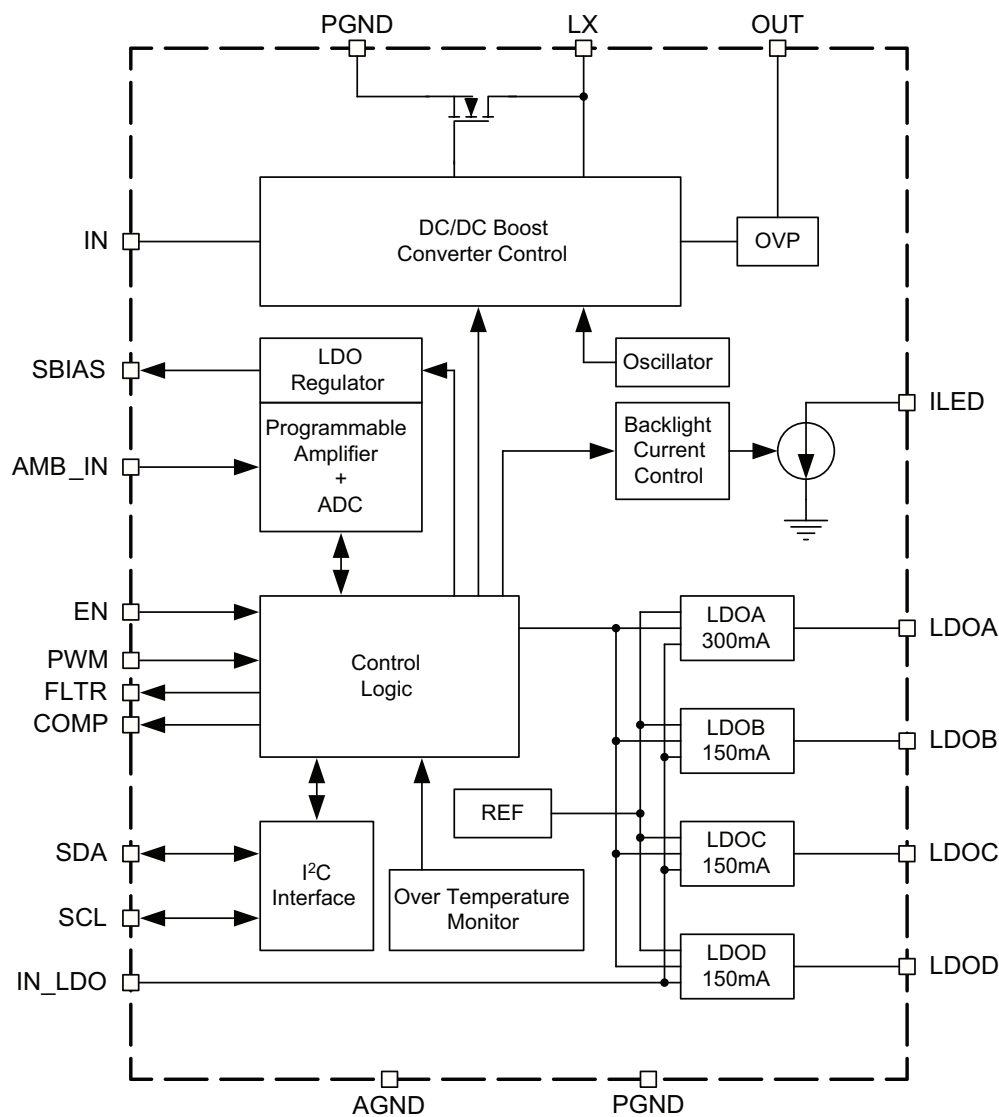
CABC Compatible, Ambient Light Control Boost LED Backlight Driver and Four LDOs**Functional Block Diagram****Functional Description**

The AAT2893 integrates a high voltage DC/DC boost converter and an internally programmed over-voltage protection circuit. It drives up to 10 backlight LEDs in series from a 3.0V to 5.5V input voltage source. To reduce overall power consumption, the AAT2893 supports CABC by providing high frequency filtered PWM for content based dimming and automatic ambient light sensing for varying lighting conditions. The ambient light control (ALC) includes a regulated bias supply to power an ALS or a photo diode. The integrated ADC polls the

ambient light conditions and is readable through the I²C interface. The ambient light control (ALC) can also be configured to automatically adjust backlight brightness for changing ambient lighting conditions.

LED Driver

The AAT2893 is capable of driving up to 10 backlight LEDs in series with 128 programmable constant current levels up to 28.6mA. The inductive DC/DC boost converter operates at a high, 1.3MHz switching frequency allowing the use of small external 1.0μF-4.7μF ceramic

CABC Compatible, Ambient Light Control Boost LED Backlight Driver and Four LDOs

capacitors and requiring a 4.7 μ H-22 μ H inductor. The output of the DC/DC boost converter is controlled by the voltage across the LED current sink when programmed for a desired LED forward current. An over-voltage protection feedback is provided to prevent damage to the LED string or system when an over-voltage event occurs at the output of the boost converter.

LED Current Control

The backlight LED string constant current level is controlled through the I²C interface. The backlight LED current can be set between 0mA and 28.6mA in steps of approximately 0.23mA. All backlight LED functions including fading, ambient light control and constant current levels are programmed through the I²C interface.

Ambient Light Sensing

The AAT2893 ALC circuit provides an interface and control for external ambient light sensor module or photo diode. The system incorporates a programmable sensor voltage bias supply (SBIAS) which may be configured to output 3.0V, 2.8V, 2.7V or 2.6V and may source up to 30mA. The ALS input has a programmable gain amplifier and ADC. The current ambient light level data can be read through the I²C interface for other system functions. When the ALC is enabled to directly adjust the backlight, the 16 internal registers with pre-configured backlight dimming levels are used to profile 16 different ambient lighting conditions. To save power and improve system efficiency, the ALC circuit features manual polling and automatic polling with programmable polling times. Under polling control, the SBIAS regulator, ambient light sensor and ADC circuit are disabled and only enabled for a short period to sample and store the present ambient light value in the ALS digital output read register. The ADC continuously filters out the 50Hz and 60Hz flicker noise from indoor lighting, eliminating the need for a large capacitor at the output pin of the ambient light sensor.

LDO Regulators

The AAT2893 includes four low dropout (LDO) linear regulators. These regulators are programmable through the I²C interface. LDOA is designed to provide load current up to 300mA, and LDOB, C and D are intended for loads up to 150mA respectively. The output voltage of each LDO can be set to one of 16 levels between 1.2V and 3.3V. The LDO regulators turn on/off and regulate output voltage level by programming through the I²C

interface. Additionally, the I²C interface allows the LDO regulators to be enabled independently for any combination of output voltages. The LDO regulators require a small 2.2 μ F (LDOB/C/D) and a 4.7 μ F (LDOA) ceramic output capacitor for maximized performance and stability. If improved load transient response is required, larger value capacitors can be used without stability degradation.

Serial Programmed Registers

The AAT2893 has 28 registers listed in Table 1:

- Four for backlight enable, control and configuration of fade in/out function
- Twenty-one for ambient light sensor control and configuration and
- Three for LDOs control and configuration.

Backlight Current Programming

The backlight string current is disabled by default. The backlight current can be easily configured by using ILED (00h) registers. LED string needs to be enabled by setting BL_EN=1 from BL_ENBLS (01h) register. The current default setting is 19.8mA.

Fade In/Fade Out Programming

The fade in/out function allows LEDs to fade between two programmed current levels in a smooth, logarithmic progression. By default, fade in/out is enabled (bits FADE_EN and FADE_INIT have a default value of 1). The fade in/out function can be disabled by writing FADE_EN =0 in FADE (03h) register. The fade function can be interrupted by writing the FADE_EN bit to 0 when a fade event is in progress. When this happens, the current will abruptly change to the ceiling value programmed in BL<7:0> bits in ILED register. The duration of the fade in/out sequences can be programmed by setting FTIME<1:0> in FADE register. The default fade in/out timing is 1s.

Fade In Function

At initial start up, the LED string turns on with a default value of 19.8mA per channel unless fade in has been specifically programmed. The lower current (floor) is programmed using FLR[3:0] bits in FADE_FLR register. The default is 0.45mA per channel. The higher current (ceiling) is programmed using bits BL [6:0] in ILED (00h) register. Fade in sequence is initiated when FADE_INIT is changed from 0 to 1 in FADE (03h) register.

AAT2893

CABC Compatible, Ambient Light Control Boost LED Backlight Driver and Four LDOs

Fade Out Function

The fade out sequence is initiated when FADE_INIT is changed from 1 to 0 in FADE (03h) register. The floor current will persist until LED string is disabled by writing BL_EN=1 to BL_ENBLS (01h) register.

I²C Serial Interface Protocol

The AAT2893 uses an I²C serial interface to set backlight LED current, LDO on/off and output voltage, as well as other housekeeping functions. The AAT2893 acts only as a slave device. The I²C protocol uses two open-drain inputs: SDA (serial data line) and SCL (serial clock line). Both inputs require an external pull up resistor, typically

to the input voltage. The I²C protocol is bidirectional. The timing diagram in Figure 1 shows the typical I²C interface protocol.

Devices on the I²C bus can either be a master or a slave. Both master and slave devices can send and receive data over the bus, the difference being that the master device controls all communication on the bus. The I²C communications begin by the master making a START condition. Next the master transmits the 7-bit device address and a Read/Write bit. Each slave device on the bus has a unique address. **The AAT2893's 7-bit device address is 0x60.**

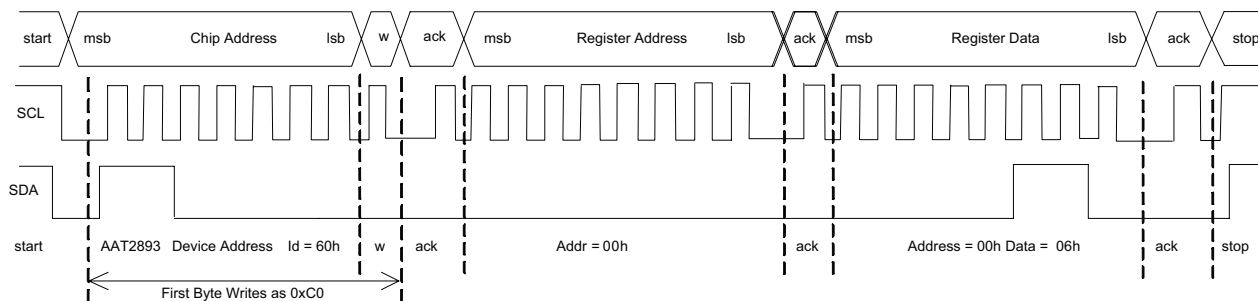

Figure 1: Typical I²C Timing Diagram.

CABC Compatible, Ambient Light Control Boost LED Backlight Driver and Four LDOs

START and STOP Conditions

START and STOP conditions are always generated by the master. Prior to initiating a START, both the SDA and SCL pin are inactive and are pulled high through external pull-up resistors. As shown in Figure 2, a START condition occurs when the master pulls the SDA line low and, after the start condition hold time (t_{HD_STA}), the master strobes

the SCL line low. A START condition acts as a signal to devices on the bus that the device producing the START condition is active and will be communicating on the bus.

A STOP condition, as shown in Figure 2, occurs when SCL changes from low to high followed after the STOP condition setup time (t_{SU_STO}), by an SDA low-to-high transition. The master does not issue an ACK but releases SCL and SDA.



Figure 2: I²C STOP and START Conditions;
START: A High "1" to Low "0" Transition on the SDA Line While SCL is High "1"
STOP: A Low "0" to High "1" Transition on the SDA Line While SCL is High "1".

Transferring Data

Addresses and data are sent with the most significant bit first transmitted and the least significant bit transmitted last. After each address or data transmission, the target

device transmits an ACK signal to indicate that it has received the transmission. The ACK signal is generated by the target after the master releases the SDA data line by driving SDA low.

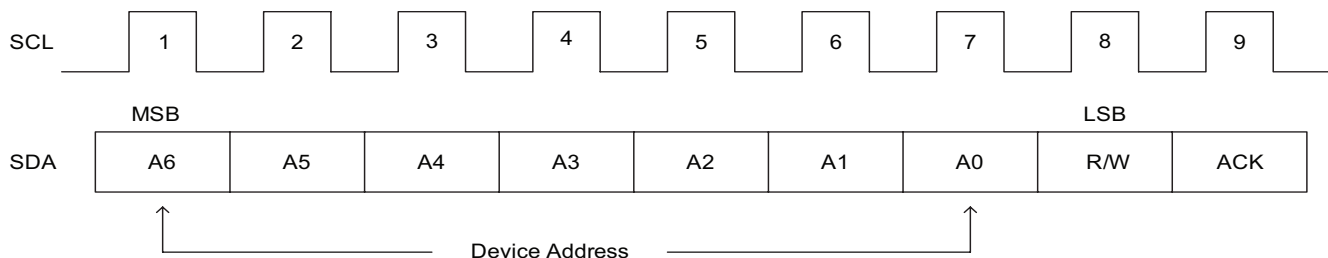

Figure 3: I²C Address Bit Map;
7-bit Slave Address (A6-A0), 1-bit Read/Write (R/W), 1-bit Acknowledge (ACK).

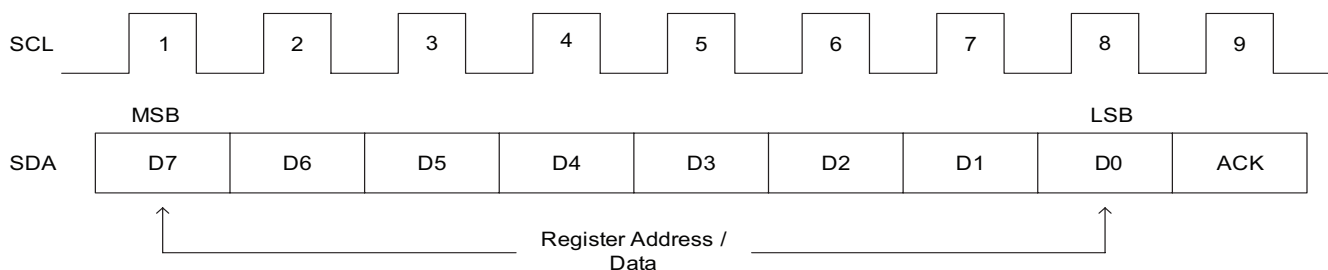

Figure 4: I²C Register Address and Data Bit Map;
8-bit Data (D7-D0), 1-bit Acknowledge (ACK).

AAT2893

CABC Compatible, Ambient Light Control Boost LED Backlight Driver and Four LDOs

Writing to Slave Device

When the Read/Write bit is set to 0 and the address transmitted by the master matches the slave device's address, the slave device transmits an Acknowledge (ACK) signal to indicate that it is ready to receive data. Next, the master transmits the 8-bit register address,

and the slave device transmits an ACK to indicate that it received the register address. After that, the master transmits the 8-bit data word, and again the slave device transmits an ACK indicating that it received the data. This process continues until the master finishes writing to the slave device at which time the master generates a STOP condition.

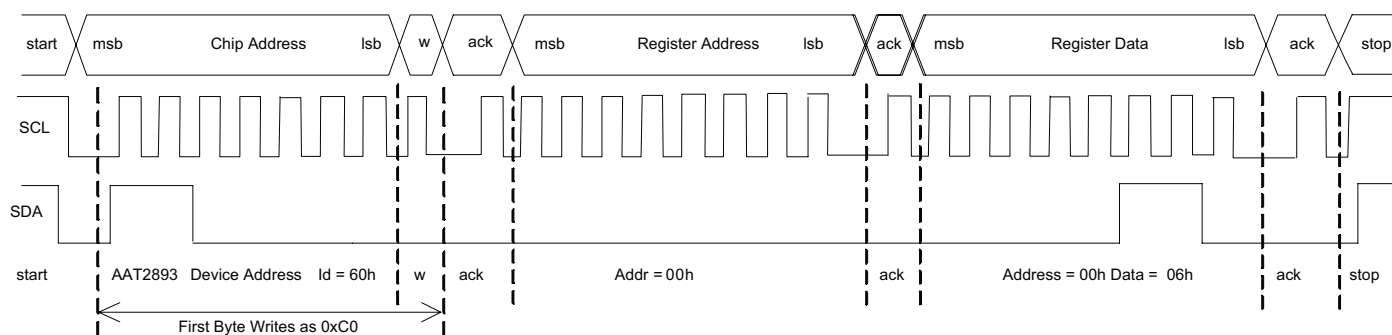

Figure 5: AAT2893 I²C Write Timing Diagram.

Reading from Slave Device

When the Read/Write bit is set to 1 and the address transmitted by the master matches the slave device's address, the slave device transmits an Acknowledge (ACK) signal to indicate that it is ready to receive data.

Next, the slave device transmits the 8-bit data word, and the master reads the data byte and transmits an Acknowledge ACK to indicate that it received the byte, and generates a STOP condition.

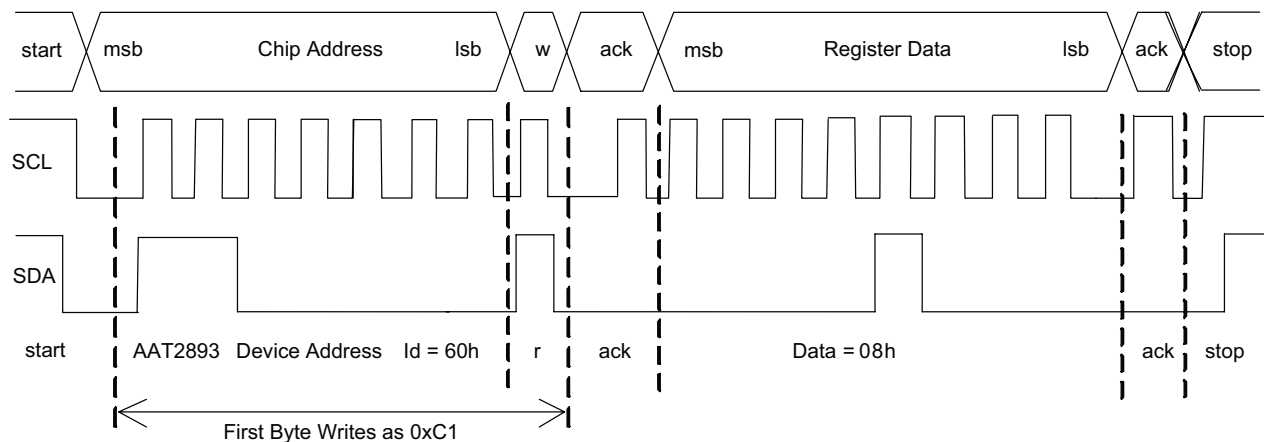

Figure 6: AAT2893 I²C Read Timing Diagram.

CABC Compatible, Ambient Light Control Boost LED Backlight Driver and Four LDOs

Serial Programmed Registers

The AAT2893's I²C programming registers are listed in Table 1.

Register		Function	Bit7	Bit6	Bit5	Bit4	Bit3	Bit2	Bit1	Bit0	Figures
Name	Hex Code										
ILED	00h	Backlight LED Current	0	BL[6]	BL[5]	BL[4]	BL[3]	BL[2]	BL[1]	BL[0]	Figure.7
BL_EN-BLS	01h	BL & CABC Enables	0	0	0	0	0	0	BL_EN	CABC_EN	Figure.8
FADE_FLR	02h	Fade Floor	0	0	0	0	FLR[3]	FLR[2]	FLR[1]	FLR[0]	Figure.9
FADE	03h	Fade Control					FTIME[1]	FTIME[0]	FADE_EN	INIT_FADE	Figure.10
ALC_FADE	04h	ALC Fade Time					ALCFU[1]	ALCFU[0]	ALCFD[1]	ALCFD[0]	Figure.11
ALS_CFG0	05h	ALS Functions	PMODE	RSET[2]	RSET[1]	RSET[0]	GAIN[1]	GAIN[0]	GM_SEL	ALS_EN	Figure.12
ALS_CFG1	06h	SBIAS ON/OFF	OFF_TM	OS_ADJ[3]	OS_ADJ[2]	OS_ADJ[1]	OS_ADJ[0]	SB[1]	SB[0]	SB_EN	Figure.13
ALS_CFG2	07h	ALS input gain/offset	SNSR	ALSOUT	PTIME[1]	PTIME[0]	G_ADJ[3]	G_ADJ[2]	G_ADJ[1]	G_ADJ[0]	Figure.14
AMLRB	08h	Ambient Level (Read)	AMB[7]	AMB[6]	AMB[5]	AMB[4]	AMB[3]	AMB[2]	AMB[1]	AMB[0]	Figure.15
ALS_BL0	09h	ALS Data		ALS0[6]	ALS0[5]	ALS0[4]	ALS0[3]	ALS0[2]	ALS0[1]	ALS0[0]	Figure.16
ALS_BL1	0Ah	ALS Data		ALS1[6]	ALS1[5]	ALS1[4]	ALS1[3]	ALS1[2]	ALS1[1]	ALS1[0]	
ALS_BL2	0Bh	ALS Data		ALS2[6]	ALS2[5]	ALS2[4]	ALS2[3]	ALS2[2]	ALS2[1]	ALS2[0]	
ALS_BL3	0Ch	ALS Data		ALS3[6]	ALS3[5]	ALS3[4]	ALS3[3]	ALS3[2]	ALS3[1]	ALS3[0]	
ALS_BL4	0Dh	ALS Data		ALS4[6]	ALS4[5]	ALS4[4]	ALS4[3]	ALS4[2]	ALS4[1]	ALS4[0]	
ALS_BL5	0Eh	ALS Data		ALS5[6]	ALS5[5]	ALS5[4]	ALS5[3]	ALS5[2]	ALS5[1]	ALS5[0]	
ALS_BL6	0Fh	ALS Data		ALS6[6]	ALS6[5]	ALS6[4]	ALS6[3]	ALS6[2]	ALS6[1]	ALS6[0]	
ALS_BL7	10h	ALS Data		ALS7[6]	ALS7[5]	ALS7[4]	ALS7[3]	ALS7[2]	ALS7[1]	ALS7[0]	
ALS_BL8	11h	ALS Data		ALS8[6]	ALS8[5]	ALS8[4]	ALS8[3]	ALS8[2]	ALS8[1]	ALS8[0]	
ALS_BL9	12h	ALS Data		ALS9[6]	ALS9[5]	ALS9[4]	ALS9[3]	ALS9[2]	ALS9[1]	ALS9[0]	
ALS_BLA	13h	ALS Data		ALSA[6]	ALSA[5]	ALSA[4]	ALSA[3]	ALSA[2]	ALSA[1]	ALSA[0]	
ALS_BLB	14h	ALS Data		ALSB[6]	ALSB[5]	ALSB[4]	ALSB[3]	ALSB[2]	ALSB[1]	ALSB[0]	
ALS_BLC	15h	ALS Data		ALSC[6]	ALSC[5]	ALSC[4]	ALSC[3]	ALSC[2]	ALSC[1]	ALSC[0]	
ALS_BLD	16h	ALS Data		ALSD[6]	ALSD[5]	ALSD[4]	ALSD[3]	ALSD[2]	ALSD[1]	ALSD[0]	
ALS_BLE	17h	ALS Data		ALSE[6]	ALSE[5]	ALSE[4]	ALSE[3]	ALSE[2]	ALSE[1]	ALSE[0]	
ALS_BLF	18h	ALS Data		ALSF[6]	ALSF[5]	ALSF[4]	ALSF[3]	ALSF[2]	ALSF[1]	ALSF[0]	
LDO_AB	19h	LDO Select	LDOA[3]	LDOA[2]	LDOA[1]	LDOA[0]	LDOB[3]	LDOB[2]	LDOB[1]	LDOB[0]	Figure.17
LDO_CD	1Ah	LDO Select	LDOC[3]	LDOC[2]	LDOC[1]	LDOC[0]	LDOD[3]	LDOD[2]	LDOD[1]	LDOD[0]	Figure.18
LDO_EN	1Bh	LDO Enable	0	0	0	0	LDO_END	LDO_ENC	LDO_ENB	LDO_ENA	Figure.19

Table 1: AAT2893 Register Map. ("0" must be written 0; "blank" = Unassigned).

CABC Compatible, Ambient Light Control Boost LED Backlight Driver and Four LDOs

ILED: Backlight LED Current Control Register (Address 00h, Default 58h)

U-0	W-1	W-0	W-1	W-1	W-0	W-0	W-0
--	BL[6]	BL[5]	BL[4]	BL[3]	BL[2]	BL[1]	BL[0]
Bit 7							Bit 0

Bit 7 **Unassigned**

Bit 6 – Bit 0 **BL<6:0>: Backlight LED Current Magnitude**

0000000 = 0.00 mA	0101100 = 9.90 mA	1011000 = 19.80 mA
0000001 = 0.23 mA	0101101 = 10.13 mA	1011001 = 20.03 mA
0000010 = 0.45 mA	0101110 = 10.35 mA	1011010 = 20.25 mA
0000011 = 0.68 mA	0101111 = 10.58 mA	1011011 = 20.48 mA
0000100 = 0.90 mA	0110000 = 10.80 mA	1011100 = 20.70 mA
0000101 = 1.13 mA	0110001 = 11.03 mA	1011101 = 20.93 mA
0000110 = 1.35 mA	0110010 = 11.25 mA	1011110 = 21.15 mA
0000111 = 1.58 mA	0110011 = 11.48 mA	1011111 = 21.38 mA
0001000 = 1.80 mA	0110100 = 11.70 mA	1100000 = 21.60 mA
0001001 = 2.03 mA	0110101 = 11.93 mA	1100001 = 21.83 mA
0001010 = 2.25 mA	0110110 = 12.15 mA	1100010 = 22.05 mA
0001011 = 2.48 mA	0110111 = 12.38 mA	1100011 = 22.28 mA
0001100 = 2.70 mA	0111000 = 12.60 mA	1100100 = 22.50 mA
0001101 = 2.93 mA	0111001 = 12.83 mA	1100101 = 22.73 mA
0001110 = 3.15 mA	0111010 = 13.05 mA	1100110 = 22.95 mA
0001111 = 3.38 mA	0111011 = 13.28 mA	1100111 = 23.18 mA
0010000 = 3.60 mA	0111100 = 13.50 mA	1101000 = 23.40 mA
0010001 = 3.83 mA	0111101 = 13.73 mA	1101001 = 23.63 mA
0010010 = 4.05 mA	0111110 = 13.95 mA	1101010 = 23.85 mA
0010011 = 4.28 mA	0111111 = 14.18 mA	1101011 = 24.08 mA
0010100 = 4.50 mA	1000000 = 14.40 mA	1101100 = 24.30 mA
0010101 = 4.73 mA	1000001 = 14.63 mA	1101101 = 24.53 mA
0010110 = 4.95 mA	1000010 = 14.85 mA	1101110 = 24.75 mA
0010111 = 5.18 mA	1000011 = 15.08 mA	1101111 = 24.98 mA
0011000 = 5.40 mA	1000100 = 15.30 mA	1110000 = 25.20 mA
0011001 = 5.63 mA	1000101 = 15.53 mA	1110001 = 25.43 mA
0011010 = 5.85 mA	1000110 = 15.75 mA	1110010 = 25.65 mA
0011011 = 6.08 mA	1000111 = 15.98 mA	1110011 = 25.88 mA
0011100 = 6.30 mA	1001000 = 16.20 mA	1110100 = 26.10 mA
0011101 = 6.53 mA	1001001 = 16.43 mA	1110101 = 26.33 mA
0011110 = 6.75 mA	1001010 = 16.65 mA	1110110 = 26.55 mA
0011111 = 6.98 mA	1001011 = 16.88 mA	1110111 = 26.78 mA
0100000 = 7.20 mA	1001100 = 17.10 mA	1111000 = 27.00 mA
0100001 = 7.43 mA	1001101 = 17.33 mA	1111001 = 27.23 mA
0100010 = 7.65 mA	1001110 = 17.55 mA	1111010 = 27.45 mA
0100011 = 7.87 mA	1001111 = 17.78 mA	1111011 = 27.68 mA
0100100 = 8.10 mA	1010000 = 18.00 mA	1111100 = 27.90 mA
0100101 = 8.32 mA	1010001 = 18.23 mA	1111101 = 28.13 mA
0100110 = 8.55 mA	1010010 = 18.45 mA	1111110 = 28.35 mA
0100111 = 8.77 mA	1010011 = 18.68 mA	1111111 = 28.58 mA
0101000 = 9.00 mA	1010100 = 18.90 mA	
0101001 = 9.22 mA	1010101 = 19.13 mA	
0101010 = 9.45 mA	1010110 = 19.35 mA	
0101011 = 9.67 mA	1010111 = 19.58 mA	

Legend:

R = Readable bit	W = Writeable bit	U = Unassigned	n = Channel number
-v = Default value	'1' = Bit is set	'0' = Bit is cleared	x = Bit is unknown

Figure 7: Backlight Current Control Register.

CABC Compatible, Ambient Light Control Boost LED Backlight Driver and Four LDOs

BL_ENBLS: Backlight & CABC Enable Register (Address 01h Default 00h)

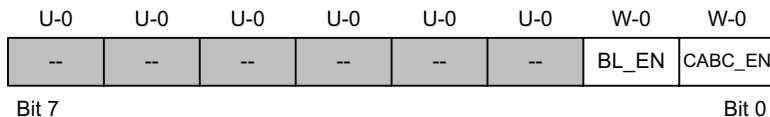

Bit 7 – Bit 2 **Unassigned**

Bit 1 **BL_EN:** Backlight Enable Register

0 = Backlight channel is disabled
1 = Backlight channel is enabled

Bit 0 **CABC_EN:** CABC PWM Input Enable Register

0 = PWM Input is active
1 = PWM Input is inactive (operating at maximum duty cycle)

Legend:

R = Readable bit	W = Writeable bit	U = Unassigned	n = Channel number
-v = Default value	'1' = Bit is set	'0' = Bit is cleared	x = Bit is unknown

Figure 8: Backlight and CABC Enable Register.

CABC Compatible, Ambient Light Control Boost LED Backlight Driver and Four LDOs

FADE_FLR: Fade In/ Out Floor Levels Register (Address 02h Default 00h)

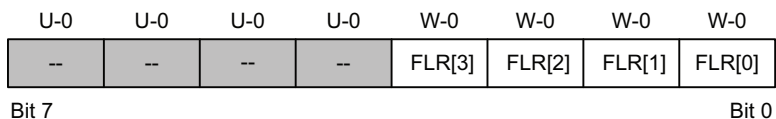
Bit 7 – Bit 4 **Unassigned**Bit 3 – Bit 0 **FLR<3:0>**: Fade In/Out Floor Levels

0000 = 0.45 mA
 0001 = 0.90 mA
 0010 = 1.80 mA
 0011 = 2.70 mA
 0100 = 3.60 mA
 0101 = 4.50 mA
 0110 = 5.40 mA
 0111 = 6.30 mA
 1000 = 7.20 mA
 1001 = 8.10 mA
 1010 = 9.00 mA
 1011 = 9.90 mA
 1100 = 10.8 mA
 1101 = 11.7 mA
 1110 = 12.6 mA
 1111 = 13.5 mA

Legend:

R = Readable bit	W = Writeable bit	U = Unassigned	n = Channel number
-v = Default value	'1' = Bit is set	'0' = Bit is cleared	x = Bit is unknown

Figure 9: Backlight Fade In/Out Level Register.

CABC Compatible, Ambient Light Control Boost LED Backlight Driver and Four LDOs

FADE: Fade In/ Out Control Register (Address 03h Default 03h)

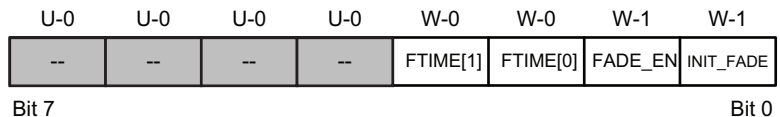

Bit 7 – Bit 4 **Unassigned**

Bit 3 – Bit 2 **FTIME<1:0>**: Fade In/Out Timing

00 = 1.0 sec
 01 = 0.8 sec
 10 = 0.6 sec
 11 = 0.4 sec

Bit 1 **FADE_EN**: Fade In/Out Enable

0 = Fade in/out is enabled for backlight group
 1 = Fade in/out is disabled for backlight group

Bit 0 **INIT_FADE**: Fade In/Out Initiation

0 = Fade out is initiated for backlight group
 1 = Fade in is initiated for backlight group

Legend:			
R = Readable bit	W = Writeable bit	U = Unassigned	n = Current Sink number
-v = Default value	'1' = Bit is set	'0' = Bit is cleared	x = Bit is unknown

Figure 10: Backlight Fade In/Out Time and Enable Control Register.

CABC Compatible, Ambient Light Control Boost LED Backlight Driver and Four LDOs

ALC_FADE: Ambient Light Control Fade up/down Time and Rate Register
(Address 04h Default 0Bh)

U-0	U-0	U-0	U-0	W-1	W-0	W-1	W-1
--	--	--	--	ALCFU[1]	ALCFU[0]	ALCFD[1]	ALCFD[0]
Bit 7				Bit 0			

Bit 7 – Bit 4 **Unassigned**

Bit 3 – Bit 2 **ALCFU<1:0>**: Ambient Light Control Fade Up Time and Rate Register

00 = Fade Up Time is 100ms, Fade Up Rate is 0.8ms/step
 01 = Fade Up Time is 200ms, Fade Up Rate is 1.6ms/step
 10 = Fade Up Time is 400ms, Fade Up Rate is 3.1ms/step
 11 = Fade Up Time is 800ms, Fade Up Rate is 6.3ms/step

Bit 1 – Bit 0 **ALCFD<1:0>**: Ambient Light Control Fade Down Time and Rate Register

00 = Fade Down Time is 50ms, Fade Down Rate is 0.4ms/step
 01 = Fade Down Time is 100ms, Fade Down Rate is 0.8ms/step
 10 = Fade Down Time is 200ms, Fade Down Rate is 1.6ms/step
 11 = Fade Down Time is 400ms, Fade Down Rate is 3.1ms/step

Legend:

R = Readable bit	W = Writeable bit	U = Unassigned	n = Current Sink number
-v = Default value	'1' = Bit is set	'0' = Bit is cleared	x = Bit is unknown

Figure 11: ALS Fade Up/Down Time and Rate Register.

CABC Compatible, Ambient Light Control Boost LED Backlight Driver and Four LDOs

ALS_CFG0: Ambient Light Sensor Input Gain Adjustment and Enable Register
(Address 05h Default 10h)

W-0	W-0	W-0	W-1	W-0	W-0	W-0	W-0
PMODE	RSET[2]	RSET[1]	RSET[0]	GAIN[1]	GAIN[0]	GM_SEL	ALS_EN
Bit 7							Bit 0

Bit 7 **PMODE:** Ambient Light Sensor (ALS) Input Gain Polling Mode Selection

0 = Automatic polling mode
1 = Manual polling mode

Bit 6 – Bit 4 **RSET<2:0>:** Ambient Light Sensor (ALS) Set Resistor Selection

000 = 500Ω, 2kΩ	100 = 8kΩ, 32kΩ
001 = 1kΩ, 4kΩ	101 = 16kΩ, 64kΩ
010 = 2kΩ, 8kΩ	110 = Reserved
011 = 4kΩ, 16kΩ	111 = Reserved

Bit 3 – Bit 2 **GAIN<1:0>:** Ambient Light Sensor (ALS) Input Amplifier Gain Mode Selection

00 = Low gain mode
01 = High gain mode
1X = Fixed gain mode (External Resistor Required)

Bit 1 **GM_SEL:** Ambient Light Sensor (ALS) Gain Mode Selection

0 = Auto gain mode
1 = Manual gain mode

Bit 0 **ALS_EN:** Ambient Light Sensor (ALS) Enable

0 = Disable ambient light sensor
1 = Enable ambient light sensor

Legend:

R = Readable bit	W = Writeable bit	U = Unassigned	n = Current Sink number
-v = Default value	'1' = Bit is set	'0' = Bit is cleared	x = Bit is unknown

Figure 12: ALS Gain Selection and Enable Register.

CABC Compatible, Ambient Light Control Boost LED Backlight Driver and Four LDOs**ALS_CFG1: Ambient Light Sensor (ALS) Voltage Bias Control Register**
(Address 06h Default 06h)

W-0	W-0	W-0	W-0	W-0	W-1	W-1	W-0
OFF_TM	OS_ADJ[3]	OS_ADJ[2]	OS_ADJ[1]	OS_ADJ[0]	SB[1]	SB[0]	SB_EN
Bit 7							Bit 0

Bit 7 **OFF_TM**: Ambient Light Sensor (ALS) Bias Offset Test Mode Enable

0 = Bias offset test mode disable
1 = Bias offset test mode enable

Bit 6 – Bit 3 **OS_ADJ<3:0>**: Ambient Light Sensor (ALS) Bias Offset Adjustment

0000 = No Adjustment
0001 = +1 LSB
0010 = +2 LSB
0011 = +3 LSB
0100 = +4 LSB
0101 = +5 LSB
0110 = +6 LSB
0111 = +7 LSB
1000 = -8 LSB
1001 = -7 LSB
1010 = -6 LSB
1011 = -5 LSB
1100 = -4 LSB
1101 = -3 LSB
1110 = -2 LSB
1111 = -1 LSB

Bit 2 – Bit 1 **SB<1:0>**: SBIAS Output Voltage Level Selection

00 = 3.0 V
01 = 2.8 V
10 = 2.7 V
11 = 2.6 V

Bit 0 **EN_SBIAS**: SBIAS Output Enable

0 = Disable SBIAS output
1 = Enable SBIAS output

Legend:

R = Readable bit	W = Writeable bit	U = Unassigned	n = Current Sink number
-v = Default value	'1' = Bit is set	'0' = Bit is cleared	x = Bit is unknown

Figure 13: ALS Voltage Bias and Offset Calibration Register

CABC Compatible, Ambient Light Control Boost LED Backlight Driver and Four LDOs

ALS_CFG2: Ambient Light Sensor (ALS) Input Gain Adjustment Register
(Address 07h Default 00h)

W-0	W-0	W-0	W-0	W-0	W-0	W-0	W-0
SNSR	ALSOUT	PTIME[1]	PTIME[0]	G_ADJ[3]	G_ADJ[2]	G_ADJ[1]	G_ADJ[0]
Bit 7							Bit 0

Bit 7 **SNSR**: Ambient Light Sensor (ALS) Linear or Logarithmic Sensor Output Selection

0 = Linear sensor output
1 = Logarithmic sensor output

Bit 6 **ALSOUT**: Ambient Light Sensor (ALS) Linear or Logarithmic Backlight Brightness Selection

0 = Linear backlight brightness
1 = Logarithmic backlight brightness

Bit 5 – Bit 4 **PTIME<1:0>**: Ambient Light Sensor (ALS) Input Gain Polling Time Selection

00 = 0.5 sec
01 = 1.0 sec
10 = 1.5 sec
11 = 2.0 sec

Bit 3 – Bit 0 **G_ADJ<3:0>**: Ambient Light Sensor (ALS) Input Gain Adjustment Selection

0000 = No Adjustment
0001 = + 6.25%
0010 = +12.50%
0011 = +18.75%
0100 = +25.00%
0101 = +31.25%
0110 = +37.50%
0111 = +43.75%
1000 = -50%
1001 = -43.75%
1010 = -37.50%
1011 = -31.25%
1100 = -25.00%
1101 = -18.75%
1110 = -12.50%
1111 = -6.25%

Legend:

R = Readable bit W = Writeable bit U = Unassigned n = Current Sink number
-v = Default value '1' = Bit is set '0' = Bit is cleared x = Bit is unknown

Figure 14: ALS Input Gain Adjustment and Polling Time Register.

CABC Compatible, Ambient Light Control Boost LED Backlight Driver and Four LDOs

AMLRB: Ambient Light Sensor (ALS) Read Data Register (Address 08h Default 00h)

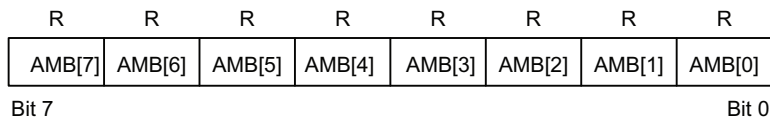

Bit 7 – Bit 0 **AMB<7:0>**: Ambient Light Sensor (ALS) Read Data Register

```

00000000 = 00
00000001 = 01
.....
.....
.....
11111111 = 7F
    
```

Legend:			
R = Readable bit	W = Writeable bit	U = Unassigned	n = Current Sink number
-v = Default value	'1' = Bit is set	'0' = Bit is cleared	x = Bit is unknown

Figure 15: ALS Digital Output Read Data Register.

CABC Compatible, Ambient Light Control Boost LED Backlight Driver and Four LDOs

ALS_BLn: Ambient Light Sensor (ALS) Backlight Current Level Programming Register
(Address 09h – Address 18h Default 00h)

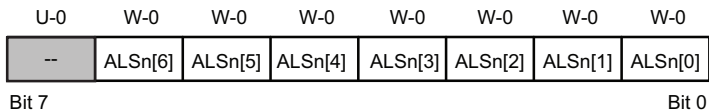

Bit 6 – Bit 0 **ALS_n<6:0>**: Ambient Light Sensor (ALS) Backlight Current Level Programming

	LED Current (Log)	LED Current (mA)	Brightness (Lux)
0000100 = 0.00		0.9	64
0000101 = 0.10		1.1	91
0000111 = 0.19		1.4	130
0001001 = 0.29		1.8	185
0001011 = 0.39		2.3	263
0001110 = 0.49		2.9	374
0010001 = 0.58		3.6	532
0010101 = 0.68		4.5	758
0011011 = 0.78		5.7	1079
0100010 = 0.88		7.2	1535
0101010 = 0.97		9.0	2185
0110100 = 1.07		11.4	3111
1000001 = 1.17		14.3	4428
1010010 = 1.26		18.0	6303
1100110 = 1.36		22.7	8971
1111111 = 1.46		28.6	12770

Legend:			
R = Readable bit	W = Writeable bit	U = Unassigned	n = Current Sink number
-v = Default value	'1' = Bit is set	'0' = Bit is cleared	x = Bit is unknown

Figure 16: ALS Controlled Current Dimming Levels Programming Register.

CABC Compatible, Ambient Light Control Boost LED Backlight Driver and Four LDOs

LDO_AB: LDOA and LDOB Output Voltage Level Programming Register
(Address 19h Default 00h)

W-0	W-0	W-0	W-0	W-0	W-0	W-0	W-0
LDOA[3]	LDOA[2]	LDOA[1]	LDOA[0]	LDOB[3]	LDOB[2]	LDOB[1]	LDOB[0]
Bit 7				Bit 0			

Bit 7 – Bit 4 **LDOA<3:0>**: LDOA Output Voltage Level Selection

0000 = 1.2V
 0001 = 1.3V
 0010 = 1.5V
 0011 = 1.6V
 0100 = 1.8V
 0101 = 2.0V
 0110 = 2.2V
 0111 = 2.5V
 1000 = 2.6V
 1001 = 2.7V
 1010 = 2.8V
 1011 = 2.9V
 1100 = 3.0V
 1101 = 3.1V
 1110 = 3.2V
 1111 = 3.3V

Bit 3 – Bit 0 **LDOB<3:0>**: LDOB Output Voltage Level Selection

0000 = 1.2V
 0001 = 1.3V
 0010 = 1.5V
 0011 = 1.6V
 0100 = 1.8V
 0101 = 2.0V
 0110 = 2.2V
 0111 = 2.5V
 1000 = 2.6V
 1001 = 2.7V
 1010 = 2.8V
 1011 = 2.9V
 1100 = 3.0V
 1101 = 3.1V
 1110 = 3.2V
 1111 = 3.3V

Legend:

R = Readable bit W = Writeable bit U = Unassigned n = Current Sink number
 -v = Default value '1' = Bit is set '0' = Bit is cleared x = Bit is unknown

Figure 17: LDOA/LDOB Output Voltage Level Programming Register.

CABC Compatible, Ambient Light Control Boost LED Backlight Driver and Four LDOs

LDO_CD: LDOC and LDOD Output Voltage Level Programming Register
(Address 1Ah Default 00h)

W-0	W-0	W-0	W-0	W-0	W-0	W-0	W-0
LDOC[3]	LDOC[2]	LDOC[1]	LDOC[0]	LDOD[3]	LDOD[2]	LDOD[1]	LDOD[0]
Bit 7				Bit 0			

Bit 7 – Bit 4 **LDOC<3:0>**: LDOC Output Voltage Level Selection

0000 = 1.2V
 0001 = 1.3V
 0010 = 1.5V
 0011 = 1.6V
 0100 = 1.8V
 0101 = 2.0V
 0110 = 2.2V
 0111 = 2.5V
 1000 = 2.6V
 1001 = 2.7V
 1010 = 2.8V
 1011 = 2.9V
 1100 = 3.0V
 1101 = 3.1V
 1110 = 3.2V
 1111 = 3.3V

Bit 3 – Bit 0 **LDOD<3:0>**: LDOD Output Voltage Level Selection

0000 = 1.2V
 0001 = 1.3V
 0010 = 1.5V
 0011 = 1.6V
 0100 = 1.8V
 0101 = 2.0V
 0110 = 2.2V
 0111 = 2.5V
 1000 = 2.6V
 1001 = 2.7V
 1010 = 2.8V
 1011 = 2.9V
 1100 = 3.0V
 1101 = 3.1V
 1110 = 3.2V
 1111 = 3.3V

Legend:

R = Readable bit	W = Writeable bit	U = Unassigned	n = Current Sink number
-v = Default value	'1' = Bit is set	'0' = Bit is cleared	x = Bit is unknown

Figure 18: LDOC/LDOD Output Voltage Level Programming Register.

CABC Compatible, Ambient Light Control Boost LED Backlight Driver and Four LDOs

LDO_EN: LDOA/B/C/D Output Enable Register (Address 1Bh Default 00h)

U-0	U-0	U-0	U-0	W-0	W-0	W-0	W-0
--	--	--	--	LDO_END	LDO_ENC	LDO_ENB	LDO_ENA
Bit 7				Bit 0			

- Bit 7 – Bit 5 **Unassigned**
- Bit 4 **LDOD_END**: LDOD Output Enable
 0 = LDOD output is disabled
 1 = LDOD output is enabled
- Bit 3 **LDOD_ENC**: LDOC Output Enable
 0 = LDOC output is disabled
 1 = LDOC output is enabled
- Bit 2 **LDOD_ENB**: LDOB Output Enable
 0 = LDOB output is disabled
 1 = LDOB output is enabled
- Bit 1 **LDOD_ENA**: LDOA Output Enable
 0 = LDOA output is disabled
 1 = LDOA output is enabled

Legend:			
R = Readable bit	W = Writeable bit	U = Unassigned	n = Current Sink number
-v = Default value	'1' = Bit is set	'0' = Bit is cleared	x = Bit is unknown

Figure 19: LDO Output Enable Register.

CABC Compatible, Ambient Light Control Boost LED Backlight Driver and Four LDOs**Application Information****Ambient Light Sensor (ALS)**

An ambient-light sensor is used to measure the brightness of the surrounding environment. Based on the brightness level, the AAT2893 can adjust the backlight LED current, leading to longer battery life and comfortable viewing with less eyestrain. The AAT2893 supports a wide range of sensors, presently on the market, and performs the gain-adjustment function to correct the part-to-part output variation of an ambient light sensor.

Some typical values of the luminance in different environments are given below as reference points:

- Moonlight: 0.2 to 1 Lux
- Candlelight: 5 Lux
- Streetlight: 10 Lux
- Office light: 300 to 1000 Lux
- Daylight (not direct sun): 10,000 Lux
- Direct sunlight: 100,000 Lux

Ambient light sensors used in smart phone applications are often placed underneath a light pipe and a glass cover. The actual light brightness reaching the ambient light sensor must be determined before choosing an ambient light sensor.

Ambient Light Sensor Selection

The types of ambient light sensors on the market include photodiodes, photo-transistors, and photo-ICs; all these types of sensors generate current or voltage output signals. Ambient light sensors with current outputs require a resistor placed at the output to convert the current into voltage. Figure 20 shows the current output, which is linear or logarithmic with the light brightness in Lux, of an ambient-light sensor. Some ambient light sensors provide logarithmic or square-root outputs. If an ambient light sensor with linear output is used while a logarithmic output is desired, the AAT2893 can convert a linear ALS output to logarithmic output by setting $SNSR = 0$ and setting $ALSOUT = 1$ in register $ALS_CFG2(07h)$ as shown in Figure 14.

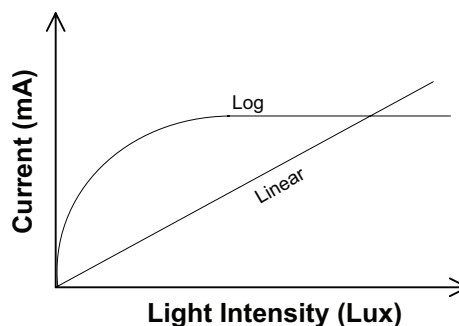

Figure 20: Ambient Light Sensor with Linear or Logarithmic Output Current.

Ambient Light Sensor Evaluation

Figure 21: Ambient Light Sensor Configuration Flowchart.

CABC Compatible, Ambient Light Control Boost LED Backlight Driver and Four LDOs

Figure 22: Ambient Light Sensor A/D Conversion Timing Diagram.

Ambient Light Sensor Gain Resistor Selection

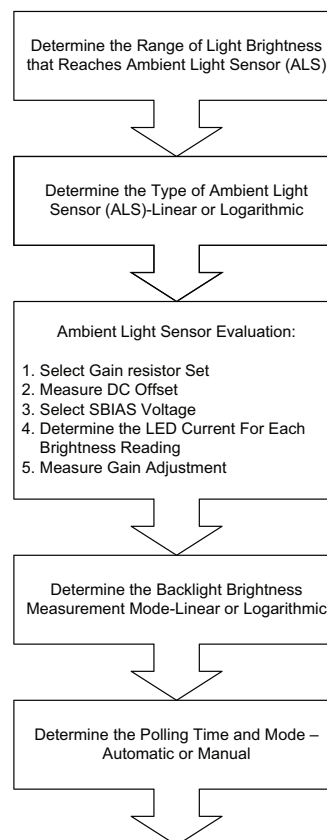
When an ambient light sensor with current output is selected, a load resistor is used to convert the output current into an output voltage. The AAT2893 provides a set of 6 internal resistor pairs that are listed in Figure 12. An external resistor can be used if none of the integrated resistor pairs fit the application requirement.

Example 1: The light luminance of the ambient light sensor is from 0 Lux to 10,000 Lux. If the output current of an ambient light sensor is 4 μ A per 100Lux, the resistor required to cover the whole luminance range can be calculated as follows:

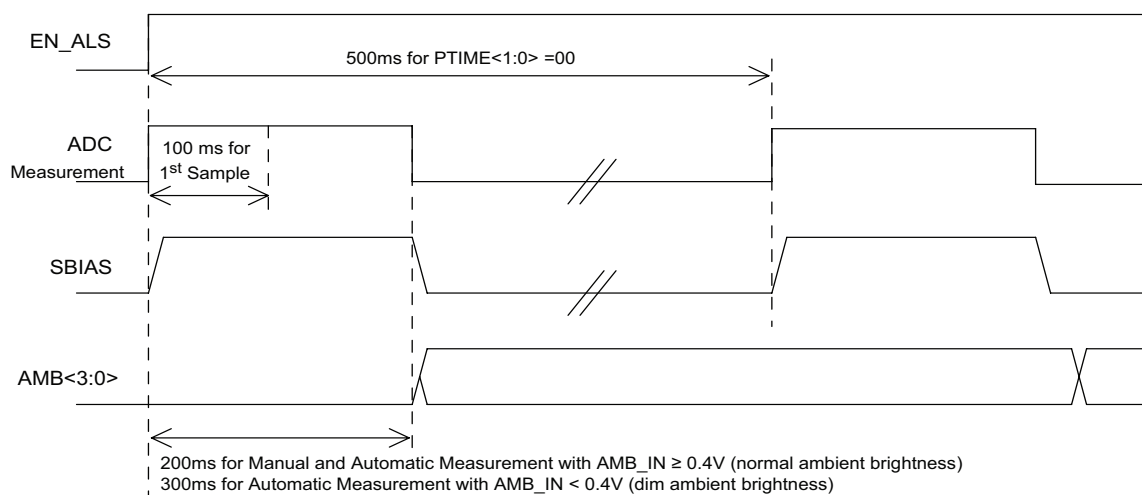
$$\text{Low-gain Resistor} = \frac{V_{\text{AMB_IN (MAX)}}}{\frac{4\mu\text{A}}{100\text{Lux}} \cdot 10000\text{Lux}} = 4\text{k}\Omega$$

The chosen resistor set is 4k Ω , 16k Ω .

Ambient Light Sensor Offset Adjustment

Any leakage current present will cause an offset at the output of the ambient light sensor, leading to inaccurate measurement of the light brightness. This offset can be corrected by programming bits OS_ADJ<3:0> in register ALS_CFG1 (06h) of the AAT2893. The four allocated bits provide offset correction from -8LSB to +7LSB, as shown in Figure 13.

The DC offset of the ambient-light sensor output can be

measured with the AAT2893. The AAT2893 is powered up and enabled with a power supply or a battery; the ambient light sensor is then enabled by writing ALS_EN = 1 to the ALS_CFG0 (05h) register (see Figure 12). The voltage bias for the ambient light sensor needs to be enabled as well by writing SB_EN = 1 to the ALS_CFG1 (06h) register (see Figure 13). The test mode of the ambient light sensor offset commences when writing OFF_TM = 1 to the ALS_CFG1 (06h) register.

Example 2: The procedure to determine the ambient light-sensor offset is explained below, assuming a resistor set of 4k Ω , 16k Ω is used:

- Connect the SBIAS pin of the AAT2893 to the input voltage pin of an ambient light sensor, and connect the AMB_IN pin of AAT2893 to the output pin of the ambient-light sensor.
- The BH1600FVC ambient light sensor from Rohm is used with the AAT2893 demo board (Figures 30 and 31). Depending on how much light goes through the light pipe and reaches the ambient light sensor, the GC1 and GC2 setting can be determined. If the range of light is up to 10,000 Lux, the L-Gain mode should be chosen by connecting GC1 to GND and GC2 to SBIAS. If the range of light is up to 3,000 Lux or lower, then the H-Gain mode should be chosen by connecting GC1 to SBIAS and GC2 to GND. The difference between H-Gain mode and L-Gain mode is the amount of output current from the ambient light sensor (see Table 6).

CABC Compatible, Ambient Light Control Boost LED Backlight Driver and Four LDOs

- The AAT2893's ambient light sensor amplifier is set to auto gain mode. The part will automatically choose the 4kΩ low-gain resistor when the ambient light is bright and the 16kΩ high-gain resistor when the ambient light is dim for better accuracy.
- Set enable pin EN = High and PWM = High to enable the AAT2893.
- Start ambient light sensor offset measurement by writing the following commands to the AAT2893:
 1. Write AAT2893 7-bit I²C address: 0x60 (first byte writes as C0h, binary 11000000).
 2. Enable backlight channel by writing to register BL_EN (01h) data 02h.
 3. Choose linear ambient light sensor gain mode and internal gain resistor pair by writing to register ALS_CFG0 (05h) data 31h.
 4. Enable SBIAS in offset test mode by writing to register ALS_CFG1 (06h) data 81h (Note: During normal operation, offset test-mode should be turned off by setting bit OFF_TM = 0 in ALS_CFG1 (06h) register as shown in Figure 13).
- Read the AMB (08h) register for the ambient light sensor output offset. AMB register has eight bits, only bits AMB[7:3] should be captured; bit AMB[7] is a sign (+ or -) bit.
- Convert the 5-bit in AMB(08h) register in test mode to a 4-bit offset according to Table 3. The 4-bit offset with opposite sign needs to be written to OS_ADJ<3:0> from ALS_CFG1 (06h) register during normal operation. **Note:** If the 5-bit offset reading is F8h (binary 11111000), then the output offset of the ambient light sensor is -1LSB. It can be converted to 1111 in 4 bits. In order to adjust this ambient light sensor offset, a +1 LSB offset needs to be added, by writing 0001 to OS_ADJ<3:0> of the ALS_CFG1 (06h) register during normal operation. For complete list of offset adjustments see Table 2.

ALS_CFG1: Ambient Light Sensor Voltage Bias and Offset Calibration Control Register									
ALS 4-Bit Offset Measurement in Test Mode					ALS 4-Bit Offset Adjustment in Normal Mode				
OS_ADJ[3]	OS_ADJ[2]	OS_ADJ[1]	OS_ADJ[0]	Offset	OS_ADJ[3]	OS_ADJ[2]	OS_ADJ[1]	OS_ADJ[0]	Offset
0	0	0	0	0	0	0	0	0	0
0	0	0	1	+1	1	1	1	1	-1
0	0	1	0	+2	1	1	1	0	-2
0	0	1	1	+3	1	1	0	1	-3
0	1	0	0	+4	1	1	0	0	-4
0	1	0	1	+5	1	0	1	1	-5
0	1	1	0	+6	1	0	1	0	-6
0	1	1	1	+7	1	0	0	1	-7
Offset too high					1	0	0	0	-8
1	0	0	0	-8	Offset too high				
1	0	0	1	-7	0	1	1	1	+7
1	0	1	0	-6	0	1	1	0	+6
1	0	1	1	-5	0	1	0	1	+5
1	1	0	0	-4	0	1	0	0	+4
1	1	0	1	-3	0	0	0	1	+3
1	1	1	0	-2	0	0	1	0	+2
1	1	1	1	-1	0	0	0	1	+1

Table 2: Ambient Light Sensor 4-Bit Offset Adjustment.

CABC Compatible, Ambient Light Control Boost LED Backlight Driver and Four LDOs

AMB: Ambient Light Sensor Digital Output Read Data Register					ALS_CFG1: Ambient Light Sensor Voltage Bias and Offset Calibration Register				
ALS 5-Bit Offset Measurement in Test Mode					ALS 4-Bit Offset Measurement in Test Mode				
AMB[7]	AMB[6]	AMB[5]	AMB[4]	AMB[3]	OS_ADJ[3]	OS_ADJ[2]	OS_ADJ[1]	OS_ADJ[0]	Offset
0	0	0	0	0	0	0	0	0	0
0	0	0	0	1	0	0	0	1	+1
0	0	0	1	0	0	0	1	0	+2
0	0	0	1	1	0	0	1	1	+3
0	0	1	0	0	0	1	0	0	+4
0	0	1	0	1	0	1	0	1	+5
0	0	1	1	0	0	1	1	0	+6
0	0	1	1	1	0	1	1	1	+7
0	1	0	0	0	Offset too high				
0	1	0	0	1					
0	1	0	1	0					
0	1	0	1	1					
0	1	1	0	0					
0	1	1	0	1					
0	1	1	1	0					
0	1	1	1	1					
1	0	0	0	0					
1	0	0	0	1					
1	0	0	1	0					
1	0	0	1	1					
1	0	1	0	0					
1	0	1	0	1					
1	0	1	1	0					
1	0	1	1	1					
1	1	0	0	0	1	0	0	0	-8
1	1	0	0	1	1	0	0	1	-7
1	1	0	1	0	1	0	1	0	-6
1	1	0	1	1	1	0	1	1	-5
1	1	1	0	0	1	1	0	0	-4
1	1	1	0	1	1	1	0	1	-3
1	1	1	1	0	1	1	1	0	-2
1	1	1	1	1	1	1	1	1	-1

Table 3: Ambient Light Sensor 5-Bit to 4-Bit Offset Conversion.

CABC Compatible, Ambient Light Control Boost LED Backlight Driver and Four LDOs**Ambient Light Sensor Gain Adjustment**

For the majority of ambient light sensors, the part-to-part variation of the output current is guaranteed to be $\pm 20\%$ at best. More expensive ambient light sensors can guarantee $\pm 10\%$ output accuracy. Tolerances in light pipes and ambient light sensors limit the output current accuracy to only $\pm 35\%$. AAT2893 allows the customer to choose an inexpensive ambient light sensor while offering a $\pm 10\%$ part-to-part variation by providing an automatic calibration gain adjustment from -50% to $+43.75\%$ for any off-the-shelf ambient light sensor. Figure 23 shows the ideal ambient light sensor output versus light brightness after gain-adjustment calibration.

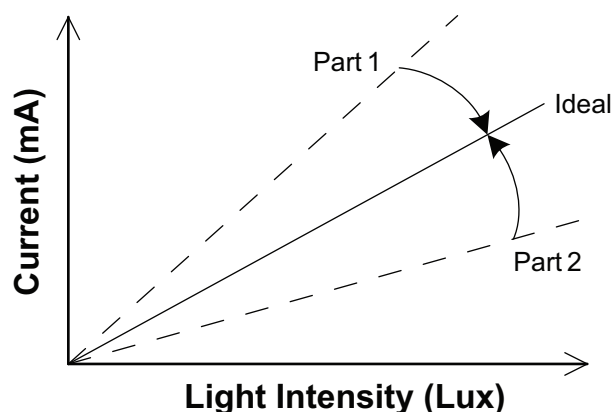

Figure 23: Ambient Light Sensor Output Current with Gain Variation.

The maximum AMB_IN input voltage is 2.4V with -37.5% gain adjustment. For optimal performance, the minimum output voltage of an ambient light sensor needs to be higher than the adjusted AMB_IN input voltage with an extra 6.25% headroom, or 2.55V according to Table 4.

Ambient Light Sensor Voltage Bias

The external ambient light sensor is powered by the SBIAS output, which is a programmable linear voltage regulator that provides up to 30mA for the sensor bias. The SBIAS output voltage may be programmed and enabled both by the ambient light sensor control register ALS_CFG0 (Figure 12) and the ambient light sensor voltage bias control register ALS_CFG1 (Figure 13). The SBIAS voltage can be selected from 2.6V up to 3V by writing bits SB<1:0> of the ALS_CFG1 (06h) register.

The SBIAS voltage is determined based on the full-scale negative gain adjustment necessary to achieve optimal performance. The relationship between the AMB_IN ideal Full-Scale voltage (unadjusted Full-Scale), the gain adjustment (Gain_ADJ), and the adjusted AMB_IN scale (Adjusted Full-Scale) can be expressed by the following equation:

$$\text{Adjusted Full-Scale} = \frac{\text{Ideal Full-Scale}}{1 + \text{Gain_ADJ}}$$

The minimum saturated output voltage of the BH1600FVC ambient light sensor is 2.6V for 3.0V supply voltage; therefore, a SBIAS voltage of 3V should be selected for this particular case. If the calculated AMB_IN maximum voltage exceeds 3V, an external voltage source is recommended.

CABC Compatible, Ambient Light Control Boost LED Backlight Driver and Four LDOs

G_ADJ[3:0]	Gain Adjustment (%)	AMB_IN Full Scale (V)	ALS_CFG2 (07h)	AMB_IN Min (V)	AMB_IN Max (V)
0111	43.75	1.11	07h	1.04	1.18
0110	37.50	1.16	06h	1.09	1.24
0101	31.25	1.22	05h	1.14	1.30
0100	25.00	1.28	04h	1.20	1.36
0011	18.75	1.35	03h	1.26	1.43
0010	12.50	1.42	02h	1.33	1.51
0001	6.25	1.51	01h	1.41	1.60
0000	0	1.60	00h	1.50	1.70
1111	-6.25	1.71	0Fh	1.60	1.81
1110	-12.5	1.83	0Eh	1.71	1.94
1101	-18.75	1.97	0Dh	1.85	2.09
1100	-25.00	2.13	0Ch	2.00	2.27
1011	-31.25	2.33	0Bh	2.18	2.47
1010	-37.50	2.56	0Ah	2.40	2.72
1001	-43.75	2.84	09h	2.67	3.02
1000	-50.00	3.20	08h	3.00	3.40

Table 4: Ambient Light Sensor Gain Adjustment.**Backlight LED Current Settings for Different Brightness Readings**

The main recipient of the light emitted by all visible spectrum LEDs is the human eye. It responds to light luminance in a non-linear, logarithmic way. The sensitivity of the human eye decreases rapidly as the luminance of the source increases. The LED current needs to change logarithmically in relation to the light brightness in order for the light brightness to be perceived linearly by the human eye.

The AAT2893 has sixteen default LED current setting

levels programmed in ALSn (from 09h to 18h) registers. These sixteen current level settings follow the logarithmic trend shown in Figure 24. A linear ambient light sensor output and a linear output brightness are set by using the default setting of SNSR=0 and ALSOUT=0 of the ALS_CFG2 (07h) register. For each light brightness sampling, one of the current levels corresponding to the ambient light reading will be selected to control the backlight LED current. If the desired current settings are different than the default, the user can change them by writing to ALSn (09h through 18h) registers.

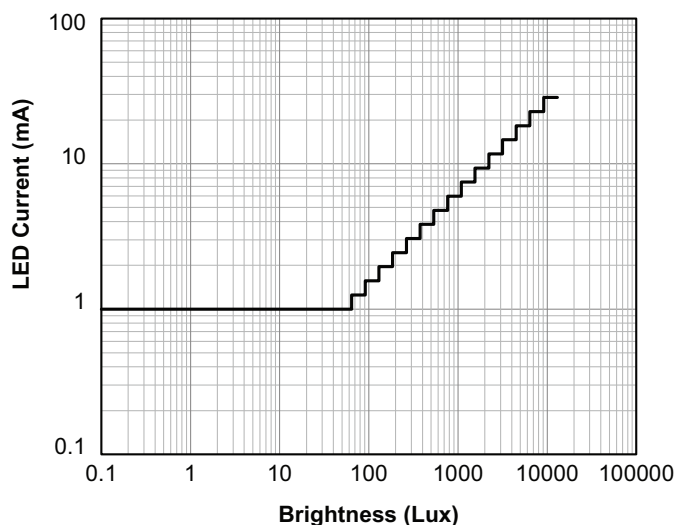
**Figure 24: Backlight LED Current vs Light Brightness.**

AAT2893

CABC Compatible, Ambient Light Control Boost LED Backlight Driver and Four LDOs

Ambient Light Sensor Brightness Gain Mode

AAT2893 allows automatic and manual modes for measurement of the ambient light sensor brightness. The automatic gain mode is selected by default value GM_SEL = 0 in ALS_CFG0 (05h) register. For better accuracy during automatic mode, the AAT2893 will choose low gain resistor when the ambient light is bright and high gain resistor when the ambient light is dim. For the manual gain mode, all light brightness measurements are completed with the low gain resistor as set by GM_SEL = 1 of the ALS_CFG0 (05h) register.

Ambient Light Sensor Brightness Polling Time

The AAT2893 offers two bits for programming the ambient light sensor brightness polling time. There are four different polling times: 0.5s, 1s, 1.5s and 2s selected by writing PTIME<1:0> bits of the ALS_CFG2 (07h) register.

If an automatic ambient light sensor polling mode is selected by default PMODE = 0 of ALS_CFG0 (05h) register, the AAT2893 will periodically update the information about the surrounding brightness at an interval of every elapsed time. Refer to Figure 22 for A/D conversion timing diagram. Manual ambient sensor polling mode can also be selected by writing PMODE = 1 to ALS_CFG0 (05h) register.

AAT2893 Programming Examples

Example 1: Ambient Light Sensor Linear Brightness Readings and Logarithmic Backlight Response

SNSR = 0: Linear Measurement

ALSOUT = 0: Linear Output

Backlight Current: Logarithmic Response

Brightness (Lux)	LED Current (mA)
1--64	0.9
64--10000	0.9 to 28.6 in log scale

Table 5: Sensor Requirements for Example 1.

Ambient light sensor model BH1600FVC from Rohm is used for all examples:

Mode	GC1	GC2	Current $\mu\text{A}/100\text{Lux}$
H-Gain Mode	1	0	60
L-Gain Mode	0	1	6.31

Table 6: Rohm BH1600FVC Ambient Light Sensor Output Current Level.

Parameter	Value
Maximum Brightness (Lux)	10000
Floor Brightness (Lux)	64
ALS Output ($\mu\text{A}/10\text{Lux}$)	0.63
Gain Resistor ($\text{K}\Omega$)	4
Gain Adjustment (%)	-18.75
AMB-IN Full-Scale (V)	1.92
Maximum. LED Current (mA)	28.60
Floor Current (mA)	0.9
Brightness / Floor	156.25
Log (Brightness / Floor)	2.19
Log current per level	0.10
Brightness / Level	662.4
k factor	0.68

Table 7: Determination of LED Current vs Brightness in a Logarithmic Relationship.

$$\text{Eq.1: } \frac{\log\left(\frac{\text{Brightness}}{\text{Floor}}\right)}{15} = 0.15$$

Setup Description:

Ambient light sensor model BH1600FVC from Rohm is used with the AAT2893 demo board (Figures 30 and 31). The demo board jumper P3 controls the gain setting GC2 and jumper P4 controls the gain setting GC1. Pin 1 (logic 1) on the jumpers P3 and P4 is designated by the square pad in Figure 28.

- Select low gain ALS output (GC1 = 0, GC2 = 1)
- Backlight LED Current=28.6mA is selected, or doesn't need to be set
- Resistor set of 4K Ω , 16K Ω is calculated for the application
- Enable Backlight channel. (BL_EN = 1)
- Ambient light sensor has no DC offset
- Ambient light sensor gain adjustment is -18.75%
- Linear ALSOUT and SNSR are selected
- SBIAS = 3.0V is selected
- Enable Ambient Light Sensor. (ALS_EN = 1)
- Light brightness is measured at 1s time intervals
- Read register AMLRB (08h).

AAT2893

CABC Compatible, Ambient Light Control Boost LED Backlight Driver and Four LDOs

- Default settings are used for ALS_BLn (09h to 18h) registers.

The following commands need to be communicated to the AAT2893 through the I²C interface:

- Write AAT2893 7-bit I²C address: 0x60 (first byte writes as C0h; binary 11000000)
- Write to register BL_ENBLS (01h) data 02h

- Write to register ALS_CFG0 (05h) data 31h
- Write to register ALS_CFG1 (06h) data 01h
- Write to register ALS_CFG2 (07h) data 1Dh
- Read register AMLRB (08h); bits AMB[7:0] indicate the ambient light brightness level; first byte writes as C1h; all readings are listed in Table 8. AMB[7] is the sign (+ or -) bit.

ALS_BLn (09h - 18h)	Light Brightness (Lux)	Log of Current/ Floor of Each Level	LED Current (mA)	AMB_IN Voltage (mV)	Register Address (Hex)	Register Data		
						(Dec)	(Hex)	(Binary)
0	64	0.00	0.9	13.10	09h	4	4h	0000100
1	726	0.10	1.1	148.73	0Ah	5	5h	0000101
2	1389	0.20	1.4	284.36	0Bh	6	6h	0000110
3	2051	0.30	1.8	419.98	0Ch	8	8h	0001000
4	2714	0.40	2.3	555.61	0Dh	10	Ah	0001010
5	3376	0.50	2.9	691.24	0Eh	13	Dh	0001101
6	4038	0.60	3.6	826.86	0Fh	16	10h	0010000
7	4701	0.70	4.5	962.49	10h	20	14h	0010100
8	5363	0.80	5.7	1098.12	11h	25	19h	0011001
9	6026	0.90	7.2	1233.74	12h	32	20h	0100000
10	6688	1.00	9.0	1369.37	13h	40	28h	0101000
11	7350	1.10	11.4	1504.99	14h	51	33h	0110011
12	8013	1.20	14.3	1640.62	15h	64	40h	1000000
13	8675	1.30	18.0	1776.25	16h	80	50h	1010000
14	9338	1.40	22.7	1911.87	17h	101	65h	1100101
15	10000	1.50	28.6	2047.50	18h	127	7Fh	1111111

Table 8: Ambient Light Sensor Linear Brightness Readings and Logarithmic Backlight Response.

Example 2: Ambient Light Sensor Linear Brightness Readings and Linear Backlight Response

SNSR = 0: Linear Measurement

ALSOUT = 0: Linear Output

Backlight Current: Linear Response

Brightness (Lux)	LED Current (mA)
1--40	5
40--10000	5 to 20

Table 9: Sensor Requirements for Example 2.

Parameter	Value
Maximum Brightness (Lux)	10000
Floor Brightness (Lux)	40
ALS Output (µA/10Lux)	0.63
Gain Resistor (kΩ)	4
Gain Adjustment (%)	-18.75
AMB-IN Full-Scale (V)	1.92
Maximum. LED Current (mA)	20
Floor Current (mA)	5
Brightness / Level (Lux)	664
LED Current per Level	1

Table 10: Determination of LED Current vs Brightness in a Logarithmic Relationship.

CABC Compatible, Ambient Light Control Boost LED Backlight Driver and Four LDOs

GC2	GC1	Mode
0	0	Shutdown
0	1	H-Gain Mode
1	0	L-Gain Mode
1	1	Test Mode (input prohibition)

Table 11: Rohm BH1600FVC Ambient Light Sensor Mode Settings.**Setup Description:**

Ambient light sensor model BH1600FVC from Rohm is used with the AAT2893 demo board (Figures 30 and 31). The demo board jumper P3 controls the gain setting GC2 and jumper P4 controls the gain setting GC1.

- Select low gain ALS output (GC1 = 0, GC2 = 1) (see Table 11)
- Resistor set of 4k Ω , 16k Ω is calculated for the application
- Enable backlight channel (BL_EN = 1)
- Ambient light sensor has no DC offset
- Ambient light sensor gain adjustment is -18.75%
- Linear ALSOUT and SNSR are selected
- SBIAS = 3.0V is selected
- Enable Ambient Light Sensor. (ALS_EN = 1)
- Light brightness is measured at an interval of 1s
- Read register AMLRB (08h)
- Write the data to ALS_BLn (09h to 18h) registers

The following commands need to be communicated to AAT2893 through I²C:

- Write AAT2893 7-bit I²C address: 0x60 (binary 11000000, first byte writes as C0h)
- Write to register BL_ENBLS (01h) data 02h
- Write to register ALS_CFG0 (05h) data 31h
- Write to register ALS_CFG1 (06h) data 01h
- Write to register ALS_CFG2 (07h) data 1Dh
- Read register AMLRB (08h); bits AMB[7:0] indicate the ambient light brightness level; first byte writes as C1h; all readings are listed in Table 12
- Write to register ALS_BL0 (09h) data 16h
- Write to register ALS_BL1 (0Ah) data 1Bh
- Write to register ALS_BL2 (0Bh) data 1Fh
- Write to register ALS_BL3 (0Ch) data 24h
- Write to register ALS_BL4 (0Dh) data 28h
- Write to register ALS_BL5 (0Eh) data 2Ch
- Write to register ALS_BL6 (0Fh) data 31h
- Write to register ALS_BL7 (10h) data 35h
- Write to register ALS_BL8 (11h) data 3Ah
- Write to register ALS_BL9 (12h) data 3Eh
- Write to register ALS_BLA (13h) data 43h
- Write to register ALS_BLB (14h) data 47h
- Write to register ALS_BLC (15h) data 4Ch
- Write to register ALS_BLD (16h) data 50h
- Write to register ALS_BLE (17h) data 54h
- Write to register ALS_BLF (18h) data 59h

ALS_BLn (09h - 18h)	Light Brightness (Lux)	LED Current (mA)	AMB_IN Voltage (mV)	Register Address (Hex)	Register Data		
					(Dec)	(Hex)	(Binary)
0	40	5.0	8.19	09h	22	16h	0010110
1	704	6.0	144.14	0Ah	27	1Bh	0011011
2	1368	7.0	280.10	0Bh	31	1Fh	0011111
3	2032	8.0	416.05	0Ch	36	24h	0100100
4	2696	9.0	552.01	0Dh	40	28h	0101000
5	3360	10.0	687.96	0Eh	44	2Ch	0101100
6	4024	11.0	823.91	0Fh	49	31h	0110001
7	4688	12.0	959.87	10h	53	35h	0110101
8	5352	13.0	1095.82	11h	58	3Ah	0111010
9	6016	14.0	1231.78	12h	62	3Eh	0111110
10	6680	15.0	1367.73	13h	67	43h	1000011
11	7344	16.0	1503.68	14h	71	47h	1000111
12	8008	17.0	1639.64	15h	76	4Ch	1001100
13	8672	18.0	1775.59	16h	80	50h	1010000
14	9336	19.0	1911.55	17h	84	54h	1010100
15	10000	20.0	2047.50	18h	89	59h	1011001

Table 12: Ambient Light Sensor Linear Brightness Readings and Linear Backlight Response.

AAT2893

CABC Compatible, Ambient Light Control Boost LED Backlight Driver and Four LDOs

Example 3: Ambient Light Sensor Logarithmic Brightness and Logarithmic Backlight Response

SNSR = 0: Linear Measurement

ALSOUT = 1: Logarithmic Output

Backlight Current: Logarithmic Response

Brightness (Lux)	LED Current (mA)
1--10	5
10--100	10
100--1000	15
1000--10000	20

Table 13: Sensor Requirements for Example 3.

Parameter	Value
Maximum Brightness (Lux)	1000
Floor Brightness (Lux)	40
ALS Output (µA/10Lux)	6
Gain Resistor (kΩ)	4
Gain Adjustment (%)	-18.75
AMB-IN Full-Scale (V)	1.92
Maximum LED Current (mA)	20
Floor Current (mA)	5
Brightness/Floor	25
Log(Brightness/Floor)	1.40
Log current per level	0.04
k factor	0.43

Table 14: Determination of LED Current vs Brightness in a Logarithmic Relationship.

Eq 2:

$$\frac{\log\left(\frac{\text{Brightness}}{\text{Floor}}\right)}{15} = 0.09$$

Setup Description:

Ambient light sensor model BH1600FVC from Rohm is used with the AAT2893 demo board (Figures 30 and 31). The demo board jumper P3 controls the gain setting GC2 and jumper P4 controls the gain setting GC1.

- Select high gain ALS output (GC1 = 1, GC2 = 0) (see Table 11).
- Resistor set of 4kΩ, 16kΩ is calculated for the application
- Enable backlight channel (BL_EN = 1)
- Ambient light sensor has no DC offset
- Ambient light sensor gain adjustment is -18.75%
- Logarithmic ALSOUT and Linear SNSR are selected
- SBIAS = 3.0V is selected
- Light brightness is measured at an interval of 1s time
- Read register AMLRB (08h)
- Write to registers ALS_BLn (09h to 18h) the data

The following commands need to be communicated to AAT2893 through I²C:

- Write AAT2893 7-bit I²C address: 0x60 (binary 11000000; first byte writes as C0h)
- Write to register BL_ENBLS (01h) data 02h
- Write to register ALS_CFG0 (05h) data 31h
- Write to register ALS_CFG1 (06h) data 01h
- Write to register ALS_CFG2 (07h) data 5Dh
- Read register AMLRB (08h); bits AMB[7:0] indicate the ambient light brightness level; first byte writes C1h; all readings are listed in Table 15.
- Write to register ALS_BL0 (09h) data 16h
- Write to register ALS_BL1 (0Ah) data 1Bh
- Write to register ALS_BL2 (0Bh) data 1Fh
- Write to register ALS_BL3 (0Ch) data 24h
- Write to register ALS_BL4 (0Dh) data 28h
- Write to register ALS_BL5 (0Eh) data 2Ch
- Write to register ALS_BL6 (0Fh) data 31h
- Write to register ALS_BL7 (10h) data 35h
- Write to register ALS_BL8 (11h) data 3Ah
- Write to register ALS_BL9 (12h) data 3Eh
- Write to register ALS_BLA (13h) data 43h
- Write to register ALS_BLB (14h) data 47h
- Write to register ALS_BLC (15h) data 4Ch
- Write to register ALS_BLD (16h) data 50h
- Write to register ALS_BLE (17h) data 54h
- Write to register ALS_BLF (18h) data 59h

CABC Compatible, Ambient Light Control Boost LED Backlight Driver and Four LDOs

ALS_BLn (09h - 18h)	Light Brightness (Lux)	Log of Brightness / Floor Level	LED Current (mA)	AMB_IN Voltage (mV)	Register Address (Hex)	Register Data		
						(Dec)	(Hex)	(Binary)
0	40	0	5.0	78.00	09h	22	16h	0010110
1	50	0.09	6.0	96.67	0Ah	27	1Bh	0011011
2	61	0.19	7.0	119.81	0Bh	31	1Fh	0011111
3	76	0.28	8.0	148.49	0Ch	36	24h	0100100
4	94	0.37	9.0	184.03	0Dh	40	28h	0101000
5	117	0.47	10.0	228.07	0Eh	44	2Ch	0101100
6	145	0.56	11.0	282.66	0Fh	49	31h	0110001
7	180	0.65	12.0	350.32	10h	53	35h	0110101
8	223	0.75	13.0	434.17	11h	58	3Ah	0111010
9	276	0.84	14.0	538.09	12h	62	3Eh	0111110
10	342	0.93	15.0	666.89	13h	67	43h	1000011
11	424	1.03	16.0	826.51	14h	71	47h	1000111
12	525	1.12	17.0	1024.35	15h	76	4Ch	1001100
13	651	1.21	18.0	1269.53	16h	80	50h	1010000
14	807	1.30	19.0	1573.40	17h	84	54h	1010100
15	1000	1.40	20.0	1950.00	18h	89	59h	1011001

Table 15: Ambient Light Sensor Logarithmic Brightness Readings and Logarithmic Backlight Response.**Content Adaptive Brightness Control (CABC)**

The CABC response to an external PWM signal is set by the filter capacitor, C_{FLTR} , connected to the FLTR pin. In order to select C_{FLTR} properly, three conditions need to be known:

1. PWM signal frequency at the PWM pin
2. The desired rate of change of the backlight current from one level to another
3. The minimum PWM duty cycle.

The capacitor (C_{FLTR}) connected to the FLTR pin has an internal resistor $R_F = 73.3k\Omega$ in parallel with ground. The filter capacitor C_{FLTR} pin is charged with a $20\mu A$ current source that is modulated with the PWM duty cycle. Refer to Figures 25 and 26 for circuit and timing diagrams.

The value for C_{FLTR} can be calculated with the following equation:

$$C_{FLTR} = \frac{t_f}{3 \cdot R_F \cdot \ln\left(\frac{D0}{D1}\right)}$$

Where,

D0 is the PWM Duty Cycle before the adjustment
and

D1 is the PWM Duty Cycle after the adjustment.

If the selected C_{FLTR} capacitor value is smaller than 5nF, then the ripple appearing on the backlight PWM current will increase. For external PWM signals equal or lower than 10% duty cycle, the bottom level of the ripple can cause the internal comparators to trip and as a result, the part will switch to a maximum duty cycle of 97.8% for a few clock periods.

If the selected C_{FLTR} value is large, the ripple on the backlight PWM current will be reduced, but it may not be possible to achieve a fast change (t_f) of the backlight current level or the desired duty cycle. Table 16 shows the recommended C_{FLTR} Value for Different t_f .

If the CABC function is not desired it can be disabled by changing bit CABC from 0 to 1 in BL_ENBLS (01h) register. The AAT2893 will operate with a maximum duty cycle of 97.8% and the C_{FLTR} capacitor is not necessary.

C_{FLTR} (nF)	t_f (ms)
6.8	1.5
10	2.8
22	3.6
33	5.1
47	6.9
68	10.2
100	18
220	40

Table 16: Recommended CFLTR Value for Different t_f .

AAT2893

CABC Compatible, Ambient Light Control Boost LED Backlight Driver and Four LDOs

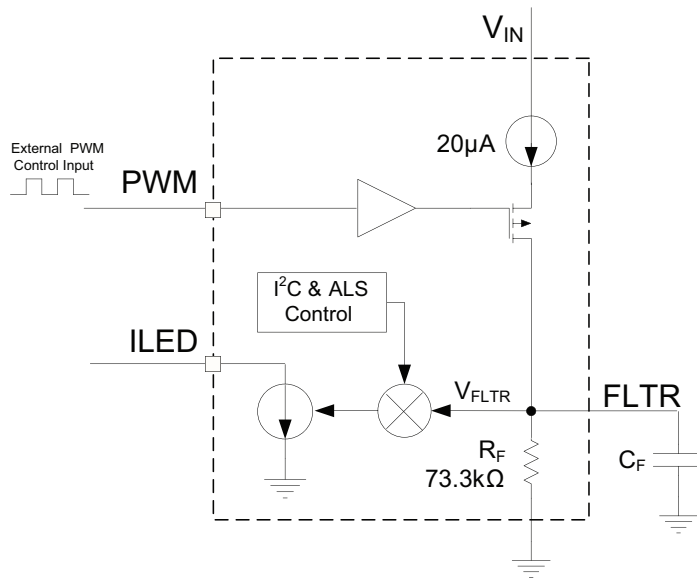

Figure 25: CABC Circuit Diagram.

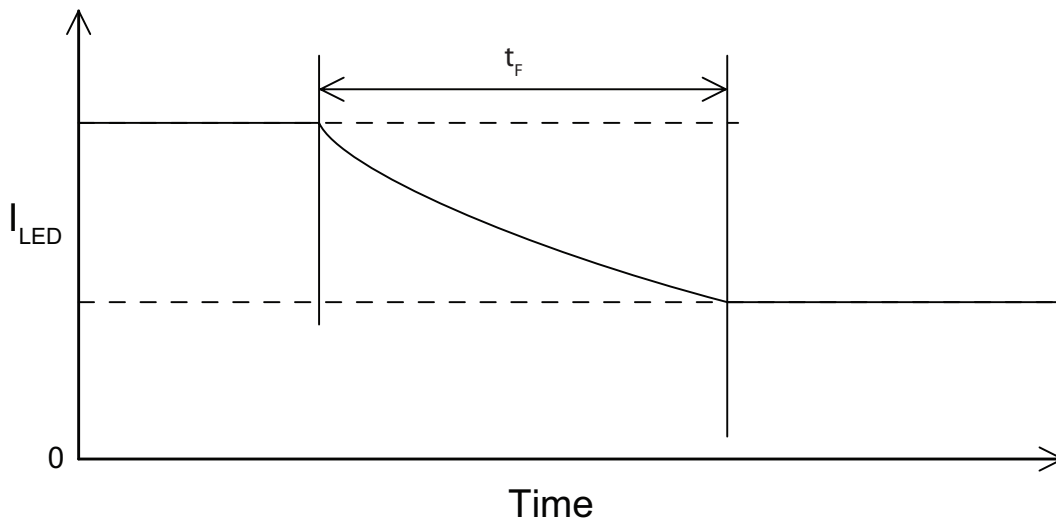

Figure 26: CABC Timing.

Note: A small value C_{FLTR} will result in faster transition time (t_F) between current levels but is limited to 5nF by the backlight PWM current ripple.

AAT2893

CABC Compatible, Ambient Light Control Boost LED Backlight Driver and Four LDOs

LED Selection

The AAT2893 is specifically designed for driving white LEDs in TFT-LCD backlighting applications but the device design allows the AAT2893 to drive most types of LEDs with forward voltage specifications ranging from 2.0V to 4.7V. LED applications may include mixed arrangements for display backlighting, color (RGB) LEDs, infrared (IR) diodes or any other load needing a constant current source generated from a varying input voltage.

The low-dropout current sinks in the AAT2893 maximize performance and make it capable of driving LEDs with high forward voltage.

Driving 11 WLEDs Application

The maximum number of WLED depends on the OVP of the AAT2893 part and the forward voltage (V_F) of WLED. The OVP of AAT2893-1 is 42V, to a general WLED with about 3.3V forward voltage, it means AAT2893 has ability to drive more than 10 LEDs in series. Figure 27, 28 and 29 show the efficiency, PWM duty vs WLED current and WLED current at different input voltage when AAT2893 drive 11 WLEDs.

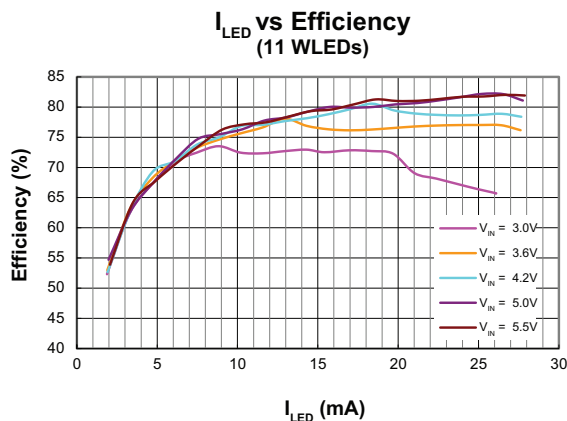

Figure 27: WLED Current vs Efficiency at 11 WLEDs Application.

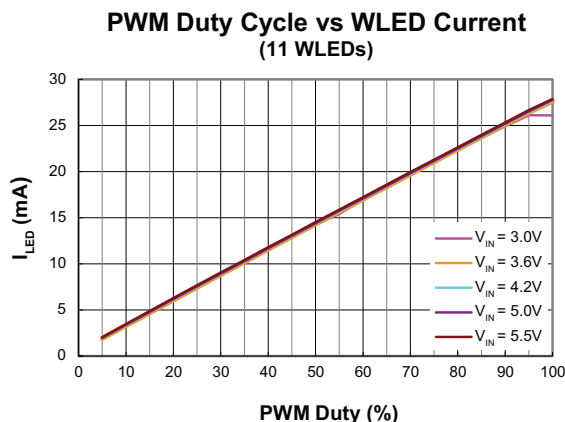

Figure 28: PWM Duty Cycle vs WLED Current at 11 WLEDs Application.

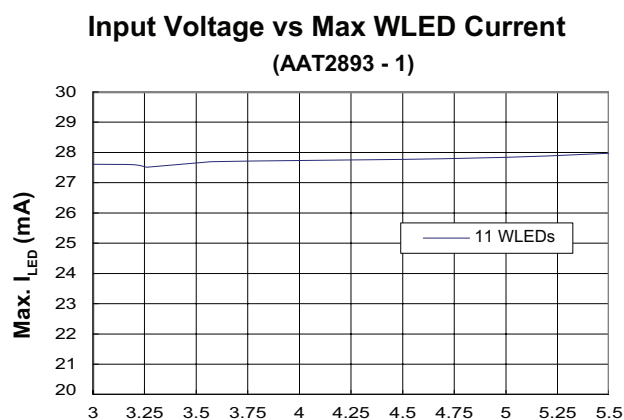

Figure 29: Input Voltage vs Max WLED Current at 11 WLEDs Application.

Inductor Selection

Inductor value, saturation current and DCR are the most important parameters in selecting an inductor for the AAT2893.

The suitable inductance range for the AAT2893 is 4.7 μ H to 22 μ H. Higher inductance lowers the step-up converter's RMS current value. Together with lower DCR value of the inductor, it makes the total inductor power loss become much lower. Considering inductor size and cost, 4.7 μ H inductance is most suitable.

Considering the inductor copper loss, the inductor DCR value together with the RMS current flowing through the

CABC Compatible, Ambient Light Control Boost LED Backlight Driver and Four LDOs

inductor leads to inductor conduction loss and also affects total efficiency. Larger DCR leads to larger conduction loss and reduces total efficiency. The inductor conduction loss can be estimated using the following equation:

$$P_{L_LOSS} = I_{L_RMS}^2 \cdot DCR = \frac{(I_{L_MAX}^2 + I_{L_MIN}^2 + I_{L_MAX} \cdot I_{L_MIN}) \cdot DCR}{3}$$

Where I_{L_MAX} and I_{L_MIN} are the inductor peak current and minimum current respectively.

Inductor saturation current is also a key parameter in selecting an inductor. For the step-up converter, the peak inductor current is the DC input current plus half the inductor peak-to-peak current ripple.

DC input current:

$$I_{IN} = \frac{V_{OUT} \cdot I_{LED}}{V_{IN} \cdot \eta}$$

Inductor peak-to-peak current ripple:

$$I_{L_PP} = \frac{V_{IN} \cdot (V_{OUT} - V_{IN})}{V_{OUT} \cdot L \cdot f}$$

Inductor peak current:

$$I_{L_PEAK} = I_{IN} + \frac{I_{L_PP}}{2} = \frac{V_{OUT} \cdot I_{LED}}{V_{IN} \cdot \eta} + \frac{V_{IN} \cdot (V_{OUT} - V_{IN})}{2 \cdot V_{OUT} \cdot L \cdot f}$$

For example, for a white LED with 3.2V V_F , 20mA current, 81% efficiency and V_{IN} less than 3.6V, the inductor peak current is:

$$I_{L_PEAK} = \frac{3.2 \cdot 8 \cdot 0.02}{3.6 \cdot 0.81} + \frac{3.6 \cdot (3.2 \cdot 8 - 3.6)}{2 \cdot 3.2 \cdot 8 \cdot 10\mu \cdot 1M} = 330mA$$

Compensation Component Selection

A compensation capacitor C_{COM} is used for step-up converter loop compensation and soft startup time control. Loop compensation requires matching values for C_{COM} , C_{OUT} , I_{LED} , and V_{OUT} :

$$\frac{C_{OUT}}{C_{COM}} < \frac{I_{LED}}{30 \cdot 10^{-6} \cdot V_{OUT}}$$

For example, considering the worse case of AAT2893 driving 10 white LEDs with forward voltages 4V, a C_{OUT} value of 1 μ F, and LED maximum current of about 30mA, the value of C_{COM} should be higher than 40nF.

$$\frac{C_{COM}}{I_{LED} \text{ (nF)}} > \frac{(C_{OUT} \cdot 30 \cdot V_{OUT})}{30 \text{ (nF)}} = \frac{(1 \cdot 30 \cdot 40)}{30 \text{ (nF)}} = 40 \text{ (nF)}$$

A higher value for C_{COM} lengthens the soft startup time. So to balance the startup time and the loop stability, 56nF is selected. The relationship between C_{COM} and startup time is almost linear, with startup time x 105 magnification of C_{COM} ; thus 56nF C_{COM} leads to a soft startup time of 5.6ms. Values of 56nF for C_{COM} and 1 μ F for C_{OUT} are suitable in most cases.

Schottky Diode Selection

To achieve maximum efficiency, a low V_F Schottky diode is recommended. For an AAT2893 driving 10 white LEDs with up to 4V forward voltage, the diode voltage rating should be higher than 40V. Selecting a diode with DC rated current being equal to the input current allows an adequate margin for safe use.

Printed Circuit Board Layout Recommendations

Boost converter performance can be adversely affected by poor layout. Possible impact includes high input and output voltage ripple, poor EMI performance, and reduced operating efficiency. Every attempt should be made to optimize the layout in order to minimize parasitic effects on PCB (stray resistance, capacitance, and inductance) and EMI coupling at the high frequency switching node. A suggested PCB layout for the AAT2893 is shown in Figures 31. The following PCB layout guidelines should be considered:

1. Place the input and output decoupling capacitors C1, C3, C5, C2, C4, C8, C9 as close to the chip as possible to reduce switching noise and output ripple.
2. Keep the power traces (GND, LX VOUT and VIN) short, direct, and wide to allow large current flow. Place sufficient multiple-layer pads, when needed, to change the trace layer.
3. Maintain a ground plane and connect to the IC PGND pin(s) as well as the PGND connections of C_{IN} and C_{OUT} .

AAT2893

CABC Compatible, Ambient Light Control Boost LED Backlight Driver and Four LDOs

Schematic and Layout

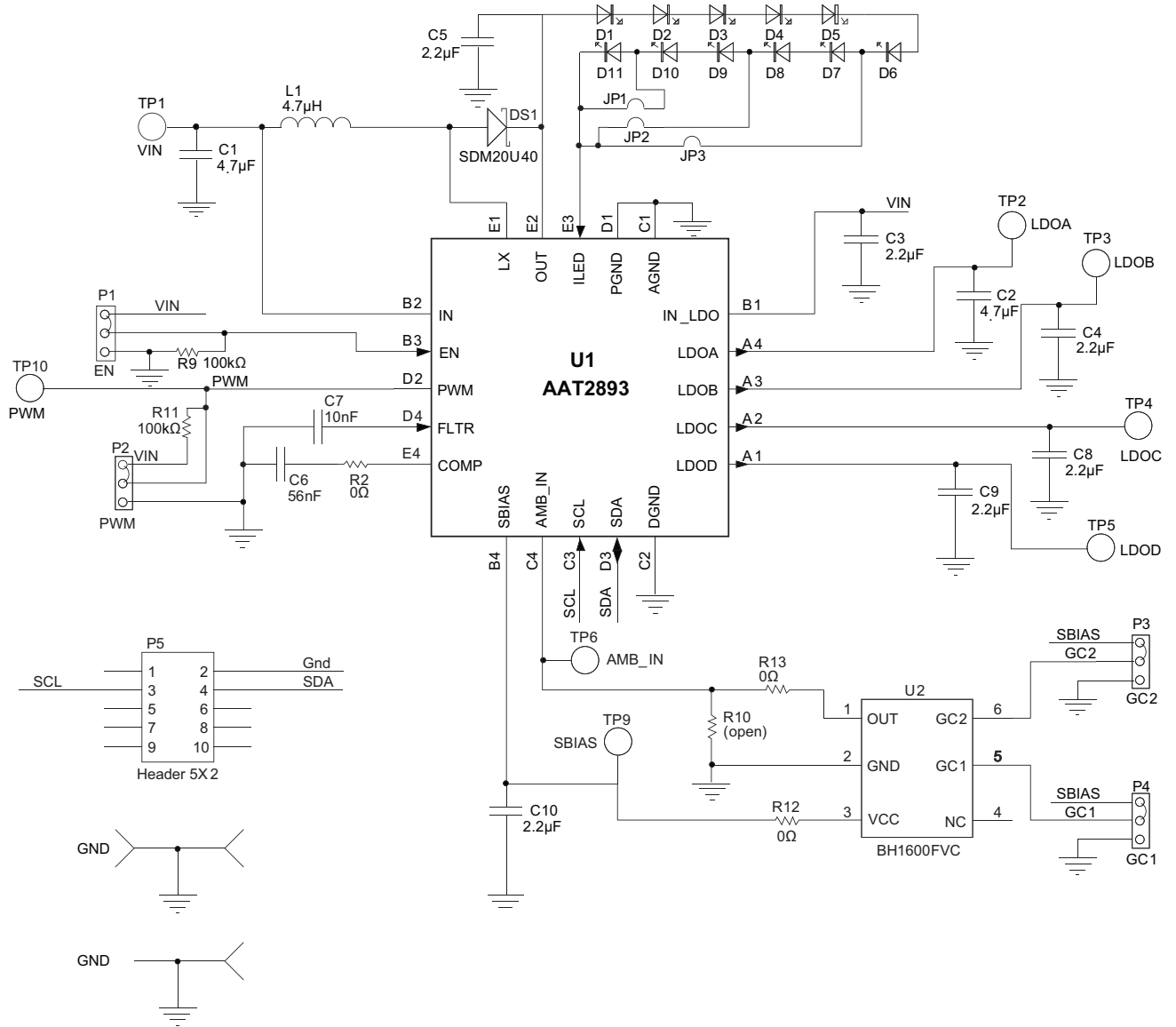

Figure 30: AAT2893 WLCSP-20 Evaluation Board Schematic.

AAT2893

CABC Compatible, Ambient Light Control Boost LED Backlight Driver and Four LDOs

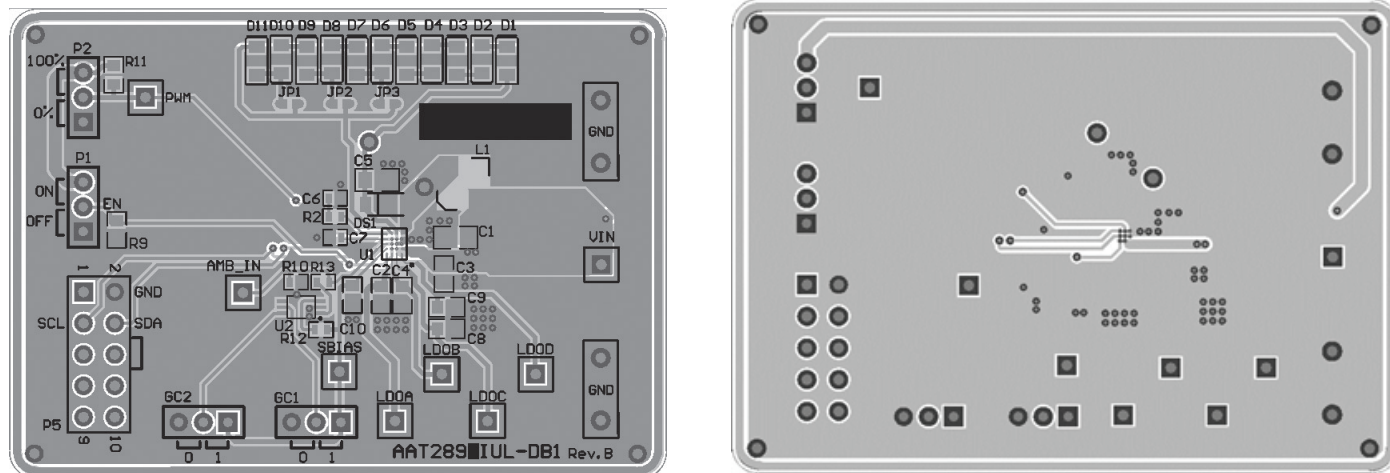

Figure 31: AAT2893 Evaluation Board Top and Bottom Side Layout.

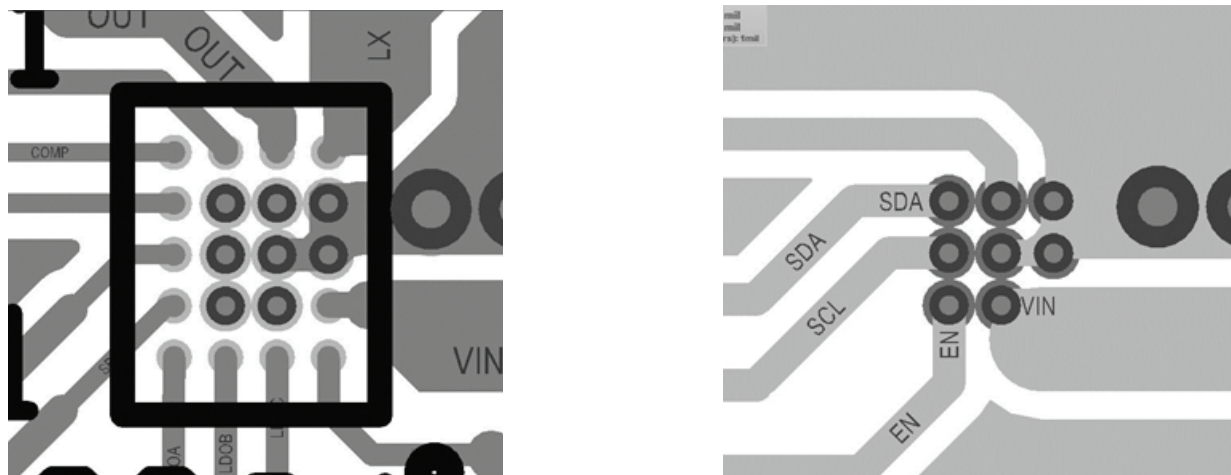

Figure 32: AAT2893 Evaluation Board WLCSP-20 package Top and Bottom Side Layout.

AAT2893**CABC Compatible, Ambient Light Control Boost LED Backlight Driver and Four LDOs**

Component	Part Number	Description	Manufacturer
U1	AAT2893IUL	Ambient Light Control Boost LED Backlight Driver IC with 4 LDOs; WLCSP20	Skyworks
U2	BH1600FVC	Ambient Light Sensor IC; WSOF6	Rohm
C1,C2	GRM188R60J475K	Cap Ceramic 4.7μF 0603 X5R 6.3V 10%	Murata
C3, C4, C8, C9, C10	GCM188R70J225KE22	2.2μF, 6.3V, X7R, 0603	
C5	GRM21BR61H225KA73L	2.2μF, 50V, X7R, 0805	
C6	GRM188R71C563K	Cap Ceramic 0.056μF 0603 X7R 16V 10%	
C7	GRM188R71H103KA01	10nF, 50V, X7R, 0603	
D1-D10	RS-0805UW	30mA White LED 0805	Realstar
D11		Not populated. Do not solder	
DS1	SDM20U40	Surface Mount Schottky Barrier Diode	Diodes
L1	CDRH3D14-4R7NC	Power Inductor 4.7μH 1.1A SMD	Sumida
P5		0.1" Header, 2x5 pins	
R2,R13, R12	Chip Resistor	0Ω, 1%, 1/8W; 0402	Vishay
R9, R11		100kΩ, 1%, 1/4W; 0603	
R10		Open, reserved for external Gain Resistor adjust	

Table 16: AAT2893 Evaluation Board Bill of Materials (BOM).

AAT2893

CABC Compatible, Ambient Light Control Boost LED Backlight Driver and Four LDOs

Ordering Information

Package	Marking ¹	OVP	Part Number (Tape and Reel) ²
WLCSP-20	V9YW	42V	AAT2893IUL-1-T1
WLCSP-20	W5YW	33V	AAT2893IUL-2-T1

 Skyworks Green™ products are compliant with all applicable legislation and are halogen-free. For additional information, refer to Skyworks Definition of Green™, document number SQ04-0074.

Package Information

WLCSP-20

Symbol	Min	Nominal	Max
A	0.565	0.650	0.735
A1	0.175	0.200	0.225
A2	0.355	0.380	0.405
A3	0.035	0.070	0.105
D	2.590	2.625	2.660
E	2.060	2.095	2.130
D1	1.600 BSC		
E1	1.200 BSC		
SD	N/A		
SE	0.200 BSC		
e	0.400 BSC		
b	0.240	0.265	0.290
X	0.600	-	-
Y	0.600	-	-
X1	-	0.200	-
Y1	-	0.200	-
N	20 Balls		

All dimensions in millimeters.

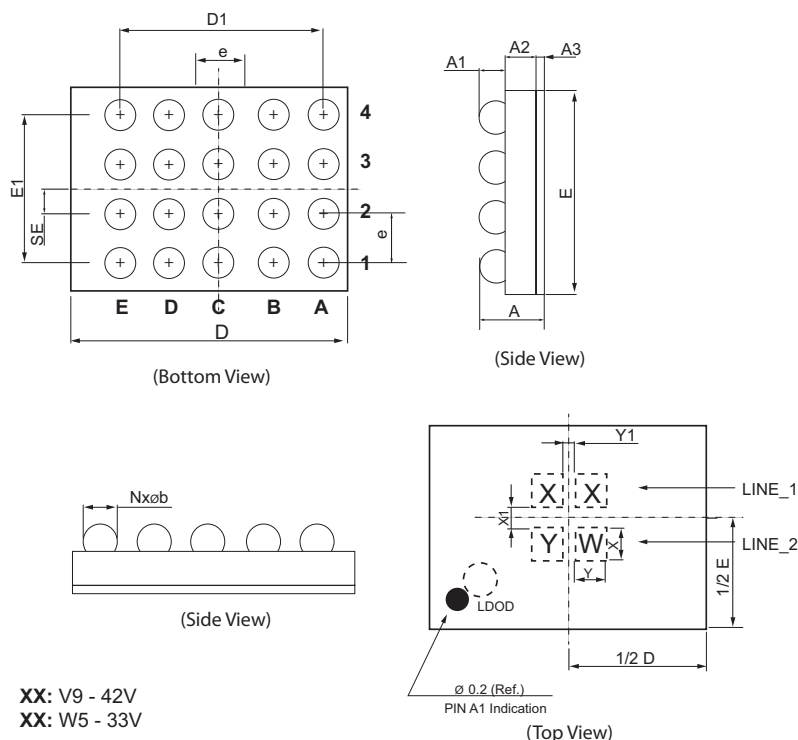

XX: V9 - 42V
XX: W5 - 33V

1. YW = Year and week code.
2. Sample stock is generally held on part numbers listed in **BOLD**.

CABC Compatible, Ambient Light Control Boost LED Backlight Driver and Four LDOs

Copyright © 2012 Skyworks Solutions, Inc. All Rights Reserved.

Information in this document is provided in connection with Skyworks Solutions, Inc. ("Skyworks") products or services. These materials, including the information contained herein, are provided by Skyworks as a service to its customers and may be used for informational purposes only by the customer. Skyworks assumes no responsibility for errors or omissions in these materials or the information contained herein. Skyworks may change its documentation, products, services, specifications or product descriptions at any time, without notice. Skyworks makes no commitment to update the materials or information and shall have no responsibility whatsoever for conflicts, incompatibilities, or other difficulties arising from any future changes.

No license, whether express, implied, by estoppel or otherwise, is granted to any intellectual property rights by this document. Skyworks assumes no liability for any materials, products or information provided hereunder, including the sale, distribution, reproduction or use of Skyworks products, information or materials, except as may be provided in Skyworks Terms and Conditions of Sale.

THE MATERIALS, PRODUCTS AND INFORMATION ARE PROVIDED "AS IS" WITHOUT WARRANTY OF ANY KIND, WHETHER EXPRESS, IMPLIED, STATUTORY, OR OTHERWISE, INCLUDING FITNESS FOR A PARTICULAR PURPOSE OR USE, MERCHANTABILITY, PERFORMANCE, QUALITY OR NON-INFRINGEMENT OF ANY INTELLECTUAL PROPERTY RIGHT; ALL SUCH WARRANTIES ARE HEREBY EXPRESSLY DISCLAIMED. SKYWORKS DOES NOT WARRANT THE ACCURACY OR COMPLETENESS OF THE INFORMATION, TEXT, GRAPHICS OR OTHER ITEMS CONTAINED WITHIN THESE MATERIALS. SKYWORKS SHALL NOT BE LIABLE FOR ANY DAMAGES, INCLUDING BUT NOT LIMITED TO ANY SPECIAL, INDIRECT, INCIDENTAL, STATUTORY, OR CONSEQUENTIAL DAMAGES, INCLUDING WITHOUT LIMITATION, LOST REVENUES OR LOST PROFITS THAT MAY RESULT FROM THE USE OF THE MATERIALS OR INFORMATION, WHETHER OR NOT THE RECIPIENT OF MATERIALS HAS BEEN ADVISED OF THE POSSIBILITY OF SUCH DAMAGE.

Skyworks products are not intended for use in medical, lifesaving or life-sustaining applications, or other equipment in which the failure of the Skyworks products could lead to personal injury, death, physical or environmental damage. Skyworks customers using or selling Skyworks products for use in such applications do so at their own risk and agree to fully indemnify Skyworks for any damages resulting from such improper use or sale.

Customers are responsible for their products and applications using Skyworks products, which may deviate from published specifications as a result of design defects, errors, or operation of products outside of published parameters or design specifications. Customers should include design and operating safeguards to minimize these and other risks. Skyworks assumes no liability for applications assistance, customer product design, or damage to any equipment resulting from the use of Skyworks products outside of stated published specifications or parameters.

Skyworks, the Skyworks symbol, and "Breakthrough Simplicity" are trademarks or registered trademarks of Skyworks Solutions, Inc., in the United States and other countries. Third-party brands and names are for identification purposes only, and are the property of their respective owners. Additional information, including relevant terms and conditions, posted at www.skyworksinc.com, are incorporated by reference.