



RF Power GaN Transistor

This 107 W asymmetrical Doherty RF power GaN transistor is designed for cellular base station applications requiring very wide instantaneous bandwidth capability covering the frequency range of 1805 to 2200 MHz.

This part is characterized and performance is guaranteed for applications operating in the 1805 to 2200 MHz band. There is no guarantee of performance when this part is used in applications designed outside of these frequencies.

1800 MHz

- Typical Doherty Single-Carrier W-CDMA Performance: $V_{DD} = 48$ Vdc, $I_{DQA} = 200$ mA, $V_{GSB} = -5$ Vdc, $P_{out} = 107$ W Avg., Input Signal PAR = 9.9 dB @ 0.01% Probability on CCDF.

Frequency	G_{ps} (dB)	η_D (%)	Output PAR (dB)	ACPR (dBc)
1805 MHz	15.3	58.4	7.1	-31.9
1840 MHz	15.4	57.7	7.0	-33.2
1880 MHz	15.4	57.7	6.7	-33.8

Features

- High terminal impedances for optimal broadband performance
- Advanced high performance in-package Doherty
- Able to withstand extremely high output VSWR and broadband operating conditions

A3G18H500-04SR3

**1805–2200 MHz, 107 W AVG., 48 V
 AIRFAST RF POWER GaN
 TRANSISTOR**

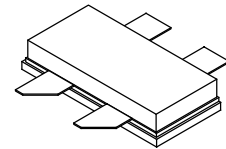

NI-780S-4L

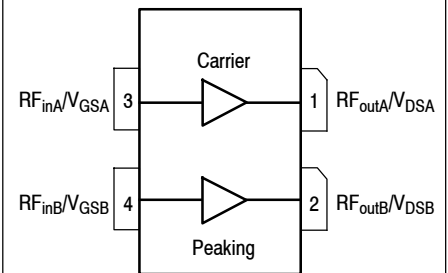

(Top View)

Figure 1. Pin Connections

Table 1. Maximum Ratings

Rating	Symbol	Value	Unit
Drain-Source Voltage	V_{DSS}	125	Vdc
Gate-Source Voltage	V_{GS}	-8, 0	Vdc
Operating Voltage	V_{DD}	0 to +55	Vdc
Maximum Forward Gate Current @ $T_C = 25^\circ\text{C}$	I_{GMAX}	25	mA
Storage Temperature Range	T_{stg}	-65 to +150	$^\circ\text{C}$
Case Operating Temperature Range	T_C	-55 to +150	$^\circ\text{C}$
Operating Junction Temperature Range	T_J	-55 to +225	$^\circ\text{C}$
Absolute Maximum Junction Temperature (1)	T_{MAX}	275	$^\circ\text{C}$

Table 2. Thermal Characteristics

Characteristic	Symbol	Value	Unit
Thermal Resistance by Infrared Measurement, Active Die Surface-to-Case Case Temperature 76°C , $P_D = 94.2\text{ W}$	$R_{\theta JC}$ (IR)	0.60 (2)	$^\circ\text{C/W}$
Thermal Resistance by Finite Element Analysis, Junction-to-Case Case Temperature 76°C , $P_D = 94.2\text{ W}$	$R_{\theta JC}$ (FEA)	1.02 (3)	$^\circ\text{C/W}$

Table 3. ESD Protection Characteristics

Test Methodology	Class
Human Body Model (per JESD22-A114)	1B
Charge Device Model (per JESD22-C101)	C3

Table 4. Electrical Characteristics ($T_A = 25^\circ\text{C}$ unless otherwise noted)

Characteristic	Symbol	Min	Typ	Max	Unit
----------------	--------	-----	-----	-----	------

Off Characteristics (4)

Drain-Source Breakdown Voltage ($V_{GS} = -8\text{ Vdc}$, $I_D = 24.3\text{ mAdc}$) ($V_{GS} = -8\text{ Vdc}$, $I_D = 35.1\text{ mAdc}$)	Carrier Peaking $V_{(BR)DSS}$	150 150	—	—	Vdc
--	-------------------------------------	------------	---	---	-----

On Characteristics - Side A, Carrier

Gate Threshold Voltage ($V_{DS} = 10\text{ Vdc}$, $I_D = 24.3\text{ mAdc}$)	$V_{GS(th)}$	-3.8	-3.0	-2.3	Vdc
Gate Quiescent Voltage ($V_{DD} = 48\text{ Vdc}$, $I_D = 200\text{ mAdc}$, Measured in Functional Test)	$V_{GSA(Q)}$	-3.6	-3.0	-2.3	Vdc
Gate-Source Leakage Current ($V_{DS} = 0\text{ Vdc}$, $V_{GS} = -5\text{ Vdc}$)	I_{GSS}	-7.5	—	—	mAdc

On Characteristics - Side B, Peaking

Gate Threshold Voltage ($V_{DS} = 10\text{ Vdc}$, $I_D = 20\text{ mAdc}$)	$V_{GS(th)}$	-3.8	-3.3	-2.3	Vdc
Gate-Source Leakage Current ($V_{DS} = 0\text{ Vdc}$, $V_{GS} = -5\text{ Vdc}$)	I_{GSS}	-7.7	—	—	mAdc

1. Functional operation above 225°C has not been characterized and is not implied. Operation at T_{MAX} (275°C) reduces median time to failure by an order of magnitude; operation beyond T_{MAX} could cause permanent damage.
2. Refer to AN1955, *Thermal Measurement Methodology of RF Power Amplifiers*. Go to <http://www.nxp.com/RF> and search for AN1955.
3. $R_{\theta JC}$ (FEA) must be used for purposes related to reliability and limitations on maximum junction temperature. MTTF may be estimated by the expression $MTTF$ (hours) = $10^{[A + B/(T + 273)]}$, where T is the junction temperature in degrees Celsius, $A = -10.3$ and $B = 8260$.
4. Each side of device measured separately.

(continued)

Table 4. Electrical Characteristics ($T_A = 25^\circ\text{C}$ unless otherwise noted) (continued)

Characteristic	Symbol	Min	Typ	Max	Unit
Functional Tests ^(1,2) (In NXP Doherty Test Fixture, 50 ohm system) $V_{DD} = 48\text{ Vdc}$, $I_{DQA} = 200\text{ mA}$, $V_{GSB} = -5\text{ Vdc}$, $P_{out} = 107\text{ W Avg.}$, $f = 1840\text{ MHz}$, Single-Carrier W-CDMA, IQ Magnitude Clipping, Input Signal PAR = 9.9 dB @ 0.01% Probability on CCDF. ACPR measured in 3.84 MHz Channel Bandwidth @ $\pm 5\text{ MHz}$ Offset. [See note on correct biasing sequence.]					
Power Gain	G_{ps}	14.5	15.4	17.5	dB
Drain Efficiency	η_D	53.0	57.7	—	%
Output Peak-to-Average Ratio @ 0.01% Probability on CCDF	PAR	6.3	7.0	—	dB
Adjacent Channel Power Ratio	ACPR	—	-33.2	-29.0	dBc

Load Mismatch (In NXP Test Fixture, 50 ohm system) $I_{DQA} = 200\text{ mA}$, $V_{GSB} = -5\text{ Vdc}$, $f = 1840\text{ MHz}$, 12 $\mu\text{sec(ON)}$, 10% Duty Cycle

VSWR 10:1 at 55 Vdc, 575 W Pulsed CW Output Power (3 dB Input Overdrive from 417 W Pulsed CW Rated Power)	No Device Degradation
--	-----------------------

Typical Performance ⁽²⁾ (In NXP Doherty Test Fixture, 50 ohm system) $V_{DD} = 48\text{ Vdc}$, $I_{DQA} = 200\text{ mA}$, $V_{GSB} = -5\text{ Vdc}$, 1805–1880 MHz Bandwidth

P_{out} @ 3 dB Compression Point ⁽³⁾	P3dB	—	537	—	W
AM/PM (Maximum value measured at the P3dB compression point across the 1805–1880 MHz bandwidth)	Φ	—	-15	—	$^\circ$
VBW Resonance Point (IMD Third Order Intermodulation Inflection Point)	VBW_{res}	—	200	—	MHz
Gain Flatness in 75 MHz Bandwidth @ $P_{out} = 107\text{ W Avg.}$	G_F	—	0.3	—	dB
Gain Variation over Temperature (-30°C to $+85^\circ\text{C}$)	ΔG	—	0.009	—	dB/ $^\circ\text{C}$
Output Power Variation over Temperature (-30°C to $+85^\circ\text{C}$)	ΔP_{1dB}	—	0.004	—	dB/ $^\circ\text{C}$

Table 5. Ordering Information

Device	Tape and Reel Information	Package
A3G18H500-04SR3	R3 Suffix = 250 Units, 32 mm Tape Width, 13-inch Reel	NI-780S-4L

- Part internally input matched.
- Measurements made with device in an asymmetrical Doherty configuration.
- P3dB = $P_{avg} + 7.0\text{ dB}$ where P_{avg} is the average output power measured using an unclipped W-CDMA single-carrier input signal where output PAR is compressed to 7.0 dB @ 0.01% probability on CCDF.

NOTE: Correct Biasing Sequence for GaN Depletion Mode Transistors in a Doherty Configuration**Bias ON the device**

- Set gate voltage V_{GSA} and V_{GSB} to -5 V .
- Set drain voltage V_{DSA} and V_{DSB} to nominal supply voltage ($+48\text{ V}$).
- Increase V_{GSA} (carrier side) until I_{DQA} current is attained.
- Increase V_{GSB} (peaking side) to target bias voltage.
- Apply RF input power to desired level.

Bias OFF the device

- Disable RF input power.
- Adjust gate voltage V_{GSA} and V_{GSB} to -5 V .
- Adjust drain voltage V_{DSA} and V_{DSB} to 0 V. Allow adequate time for drain voltage to reduce to 0 V from external drain capacitors.
- Disable V_{GSA} and V_{GSB} .

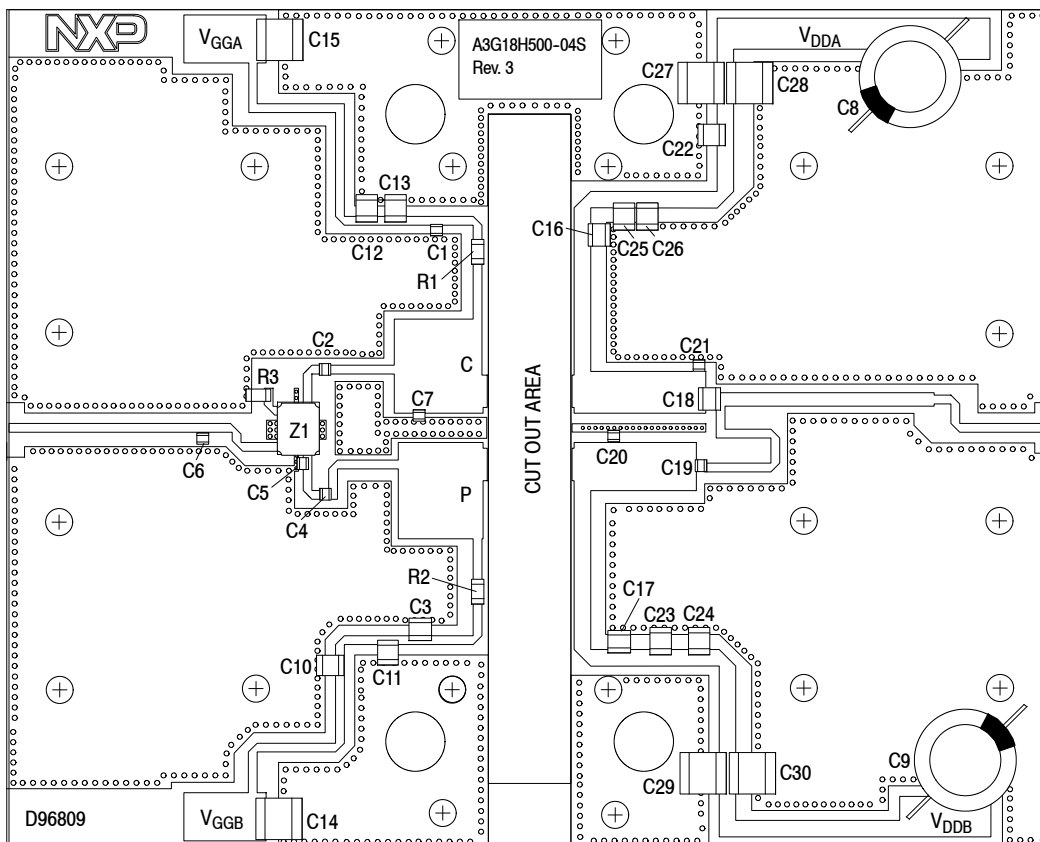

Figure 2. A3G18H500-04SR3 Test Circuit Component Layout

Table 6. A3G18H500-04SR3 Test Circuit Component Designations and Values

Part	Description	Part Number	Manufacturer
C1, C2	10 pF Chip Capacitor	GQM2195C2E100JB12	Murata
C3, C16, C17	10 pF Chip Capacitor	ATC100B100GT500XT	ATC
C4, C19	15 pF Chip Capacitor	GQM2195C2E150JB12	Murata
C5	0.9 pF Chip Capacitor	GQM2195C2ER90BB12	Murata
C6	0.8 pF Chip Capacitor	GQM2195C2ER80BB12	Murata
C7, C21	0.6 pF Chip Capacitor	GQM2195C2ER60BB12	Murata
C8, C9	470 μ F, 63 V Electrolytic Capacitor	MCGPR63V477M13X26-RH	Multicomp
C10, C11, C12, C13, C22, C23, C24, C25, C26	10 μ F Chip Capacitor	C3225X7S1H106K	TDK
C14, C15, C27, C28, C29, C30	10 μ F Chip Capacitor	C5750X7S2A106M	TDK
C18	3 pF Chip Capacitor	ATC100B3R0BT500XT	ATC
C20	1.3 pF Chip Capacitor	GQM2195C2E1R3BB12	Murata
R1, R2	3.3 Ω , 1/4 W Chip Resistor	CRCW08053R30FKEA	Vishay
R3	50 Ω , 8 W Termination Chip Resistor	C8A50Z4A	Anaren
Z1	1800–2200 MHz Band, 90°, 2 dB Directional Coupler	X3C20F1-02S	Anaren
PCB	Rogers RO4350B, 0.020", $\epsilon_r = 3.66$	D96809	MTL

TYPICAL CHARACTERISTICS — 1805–1880 MHz

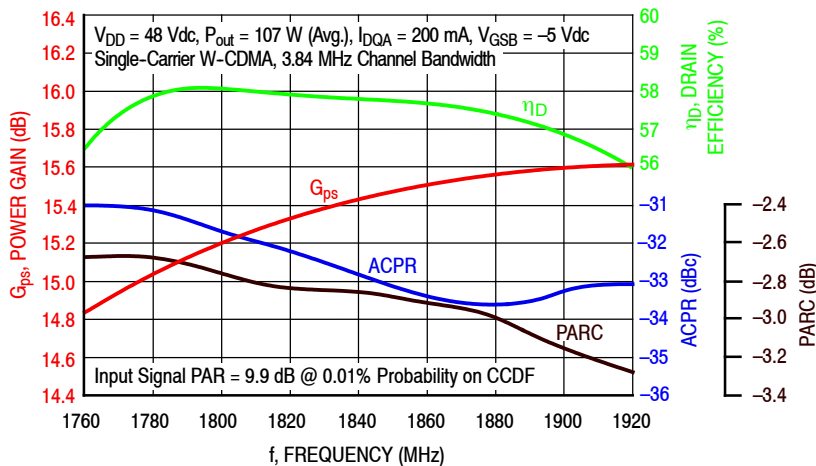

Figure 3. Single-Carrier Output Peak-to-Average Ratio Compression (PARC) Broadband Performance @ $P_{out} = 107$ Watts Avg.

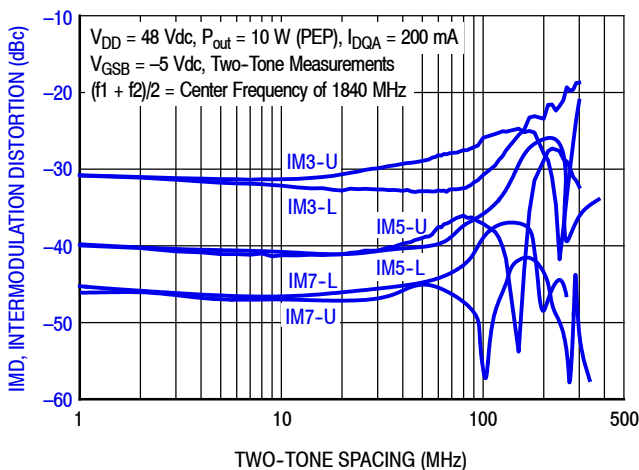

Figure 4. Intermodulation Distortion Products versus Two-Tone Spacing

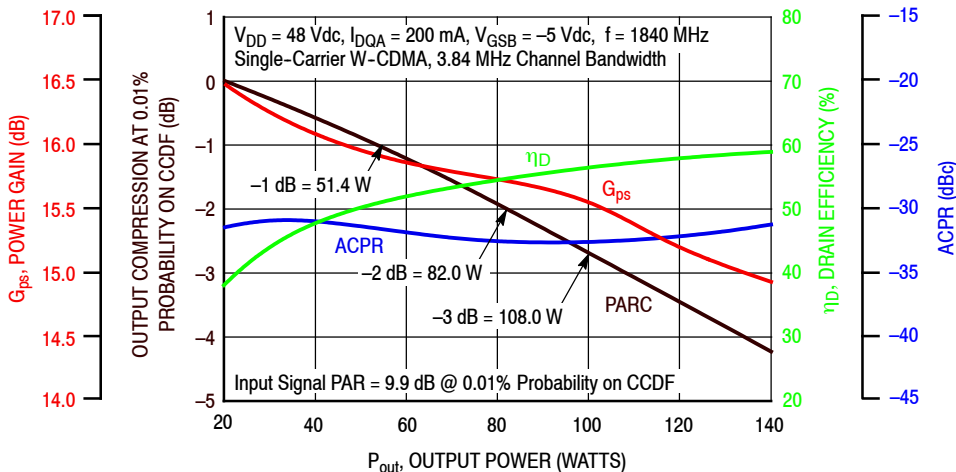

Figure 5. Output Peak-to-Average Ratio Compression (PARC) versus Output Power

TYPICAL CHARACTERISTICS — 1805–1880 MHz

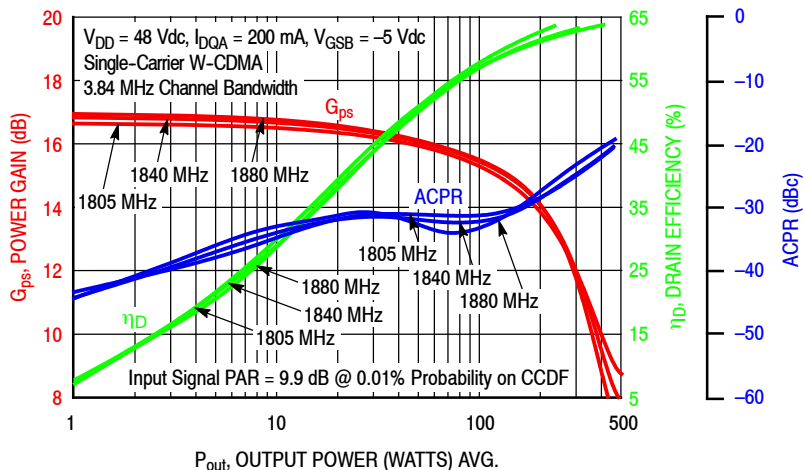

Figure 6. Single-Carrier W-CDMA Power Gain, Drain Efficiency and ACPR versus Output Power

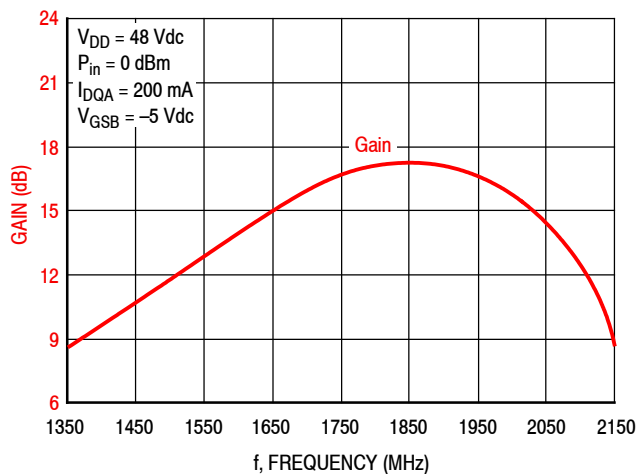

Figure 7. Broadband Frequency Response

Table 7. Carrier Side Load Pull Performance — Maximum Power Tuning

$V_{DD} = 48 \text{ Vdc}$, $I_{DQA} = 250 \text{ mA}$, Pulsed CW, $10 \mu\text{sec(on)}$, 10% Duty Cycle

f (MHz)	$Z_{\text{source}} (\Omega)$	$Z_{\text{in}} (\Omega)$	Max Output Power					
			P1dB					
			$Z_{\text{load}}^{(1)} (\Omega)$	Gain (dB)	(dBm)	(W)	η_D (%)	AM/PM (°)
1805	$2.56 - j6.80$	$2.88 + j6.46$	$4.22 - j7.66$	17.9	53.3	215	60.6	-9
1840	$3.18 - j7.25$	$3.29 + j6.72$	$4.33 - j8.32$	17.8	53.2	210	58.6	-9
1880	$3.88 - j7.65$	$3.69 + j6.85$	$4.43 - j8.45$	17.8	53.0	201	58.1	-9

f (MHz)	$Z_{\text{source}} (\Omega)$	$Z_{\text{in}} (\Omega)$	Max Output Power					
			P3dB					
			$Z_{\text{load}}^{(2)} (\Omega)$	Gain (dB)	(dBm)	(W)	η_D (%)	AM/PM (°)
1805	$2.56 - j6.80$	$2.63 + j6.74$	$5.40 - j8.08$	16.2	54.2	265	65.1	-11
1840	$3.18 - j7.25$	$3.01 + j7.11$	$5.30 - j8.38$	16.2	54.1	256	63.9	-12
1880	$3.88 - j7.65$	$3.52 + j7.35$	$5.88 - j9.20$	16.2	54.0	251	62.5	-12

(1) Load impedance for optimum P1dB power.

(2) Load impedance for optimum P3dB power.

Z_{source} = Measured impedance presented to the input of the device at the package reference plane.

Z_{in} = Impedance as measured from gate contact to ground.

Z_{load} = Measured impedance presented to the output of the device at the package reference plane.

Table 8. Carrier Side Load Pull Performance — Maximum Efficiency Tuning

$V_{DD} = 48 \text{ Vdc}$, $I_{DQA} = 250 \text{ mA}$, Pulsed CW, $10 \mu\text{sec(on)}$, 10% Duty Cycle

f (MHz)	$Z_{\text{source}} (\Omega)$	$Z_{\text{in}} (\Omega)$	Max Drain Efficiency					
			P1dB					
			$Z_{\text{load}}^{(1)} (\Omega)$	Gain (dB)	(dBm)	(W)	η_D (%)	AM/PM (°)
1805	$2.56 - j6.80$	$2.52 + j6.98$	$3.66 - j4.40$	19.4	51.8	151	71.3	-23
1840	$3.18 - j7.25$	$2.81 + j7.53$	$3.39 - j4.12$	19.6	51.0	126	70.5	-26
1880	$3.88 - j7.65$	$3.38 + j7.76$	$3.61 - j4.65$	19.5	51.1	130	68.1	-25

f (MHz)	$Z_{\text{source}} (\Omega)$	$Z_{\text{in}} (\Omega)$	Max Drain Efficiency					
			P3dB					
			$Z_{\text{load}}^{(2)} (\Omega)$	Gain (dB)	(dBm)	(W)	η_D (%)	AM/PM (°)
1805	$2.56 - j6.80$	$2.23 + j7.22$	$3.93 - j4.40$	17.5	52.6	181	75.4	-29
1840	$3.18 - j7.25$	$2.63 + j7.72$	$4.03 - j4.47$	17.6	52.4	175	74.3	-29
1880	$3.88 - j7.65$	$3.25 + j8.11$	$4.53 - j5.02$	17.7	52.5	176	72.2	-27

(1) Load impedance for optimum P1dB efficiency.

(2) Load impedance for optimum P3dB efficiency.

Z_{source} = Measured impedance presented to the input of the device at the package reference plane.

Z_{in} = Impedance as measured from gate contact to ground.

Z_{load} = Measured impedance presented to the output of the device at the package reference plane.

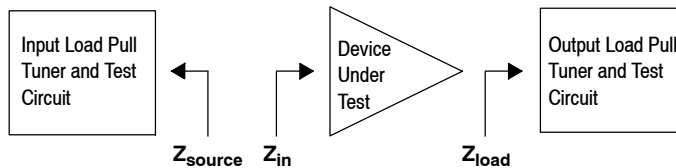

P1dB – TYPICAL CARRIER SIDE LOAD PULL CONTOURS — 1840 MHz

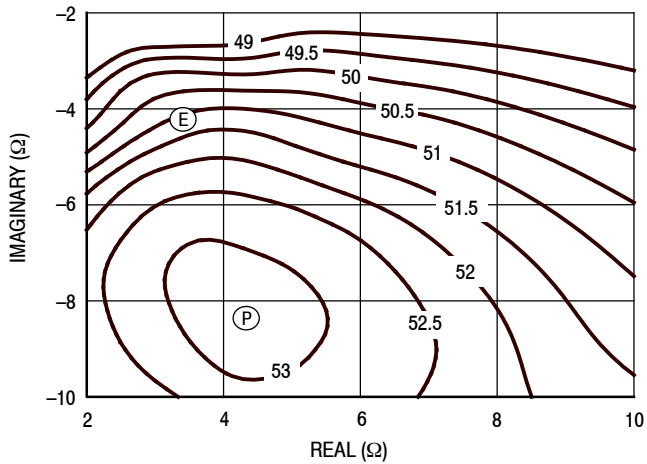

Figure 8. P1dB Load Pull Output Power Contours (dBm)

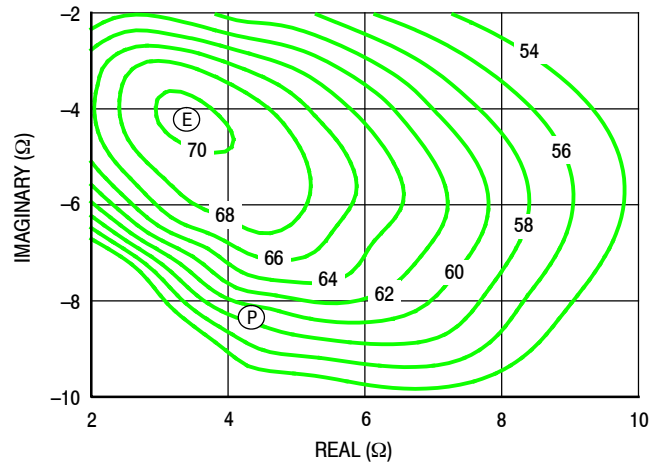

Figure 9. P1dB Load Pull Efficiency Contours (%)

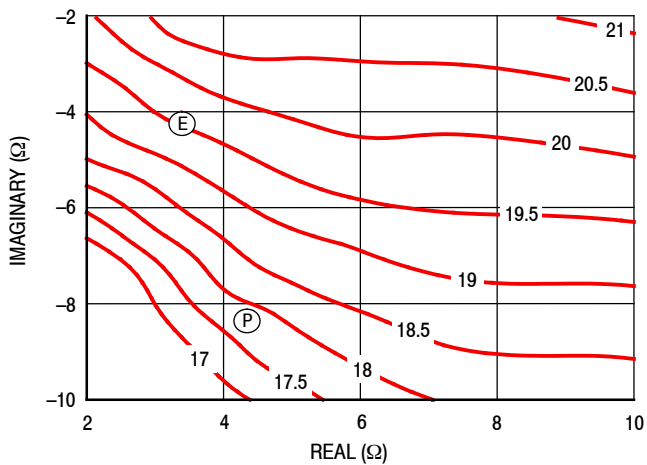

Figure 10. P1dB Load Pull Gain Contours (dB)

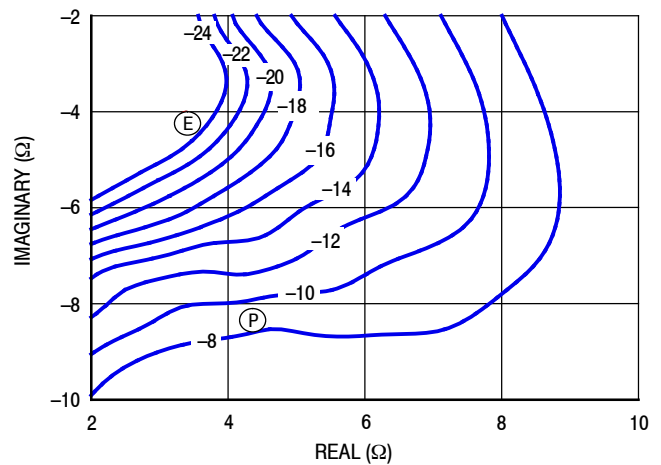

Figure 11. P1dB Load Pull AM/PM Contours (°)

NOTE: (P) = Maximum Output Power
(E) = Maximum Drain Efficiency

- Gain
- Drain Efficiency
- Linearity
- Output Power

P3dB – TYPICAL CARRIER SIDE LOAD PULL CONTOURS — 1840 MHz

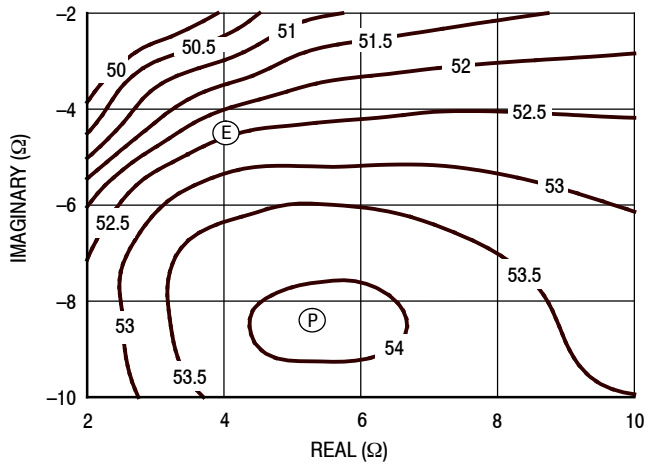

Figure 12. P3dB Load Pull Output Power Contours (dBm)

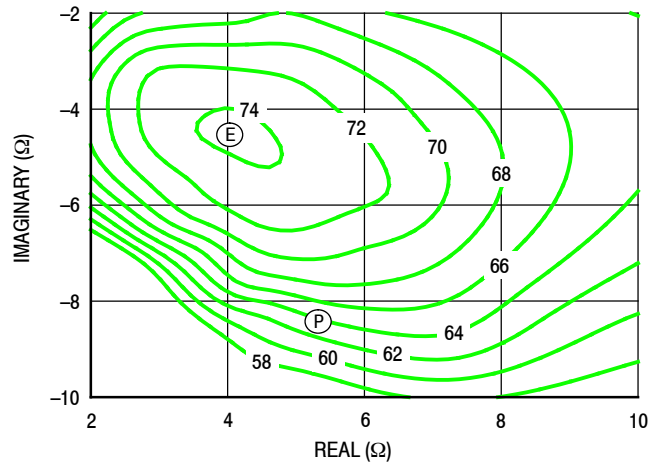

Figure 13. P3dB Load Pull Efficiency Contours (%)

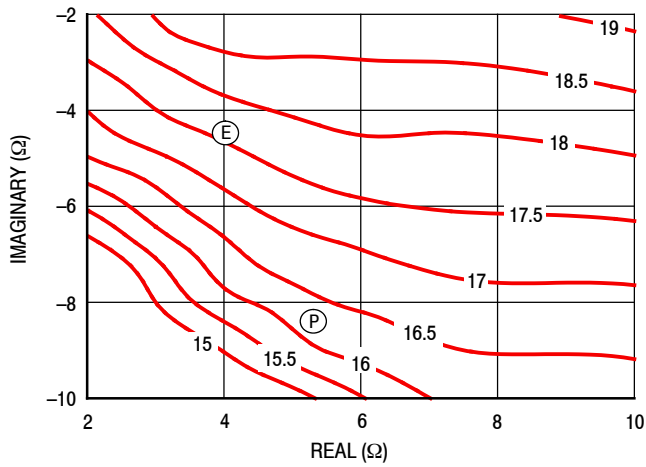

Figure 14. P3dB Load Pull Gain Contours (dB)

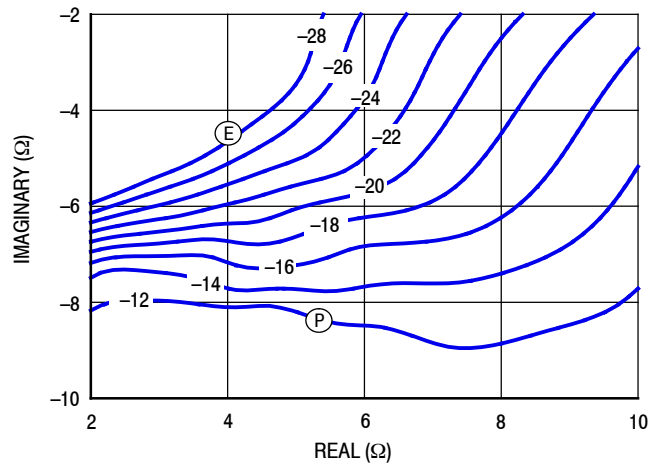

Figure 15. P3dB Load Pull AM/PM Contours (°)

NOTE: (P) = Maximum Output Power
(E) = Maximum Drain Efficiency

- Gain
- Drain Efficiency
- Linearity
- Output Power

Table 9. Peaking Side Load Pull Performance — Maximum Power Tuning

$V_{DD} = 48$ Vdc, $V_{GSB} = 3.1$ Vdc, Pulsed CW, 10 μ sec(on), 10% Duty Cycle

f (MHz)	Z_{source} (Ω)	Z_{in} (Ω)	Max Output Power					
			P1dB					
			$Z_{load}^{(1)}$ (Ω)	Gain (dB)	(dBm)	(W)	η_D (%)	AM/PM ($^\circ$)
1805	1.66 – j6.38	1.51 + j6.91	1.79 – j4.63	17.7	54.8	302	54.5	–13
1840	2.64 – j7.07	2.11 + j7.34	2.06 – j4.97	17.8	54.7	297	54.3	–13
1880	2.30 – j7.54	2.13 + j7.92	2.01 – j5.25	17.8	54.6	292	53.2	–13

f (MHz)	Z_{source} (Ω)	Z_{in} (Ω)	Max Output Power					
			P3dB					
			$Z_{load}^{(2)}$ (Ω)	Gain (dB)	(dBm)	(W)	η_D (%)	AM/PM ($^\circ$)
1805	1.66 – j6.38	1.37 + j6.95	2.61 – j5.42	16.0	56.0	398	58.7	–13
1840	2.64 – j7.07	2.02 + j7.47	2.86 – j5.78	15.9	55.8	378	56.4	–13
1880	2.30 – j7.54	2.02 + j8.07	2.87 – j5.92	16.1	55.6	365	56.8	–13

(1) Load impedance for optimum P1dB power.

(2) Load impedance for optimum P3dB power.

Z_{source} = Measured impedance presented to the input of the device at the package reference plane.

Z_{in} = Impedance as measured from gate contact to ground.

Z_{load} = Measured impedance presented to the output of the device at the package reference plane.

Table 10. Peaking Side Load Pull Performance — Maximum Efficiency Tuning

$V_{DD} = 48$ Vdc, $V_{GSB} = 3.1$ Vdc, Pulsed CW, 10 μ sec(on), 10% Duty Cycle

f (MHz)	Z_{source} (Ω)	Z_{in} (Ω)	Max Drain Efficiency					
			P1dB					
			$Z_{load}^{(1)}$ (Ω)	Gain (dB)	(dBm)	(W)	η_D (%)	AM/PM ($^\circ$)
1805	1.66 – j6.38	1.46 + j7.24	1.79 – j3.09	19.3	53.1	203	63.1	–25
1840	2.64 – j7.07	2.04 + j7.76	2.02 – j3.16	19.3	53.0	200	63.8	–25
1880	2.30 – j7.54	2.06 + j8.33	2.04 – j3.54	19.5	53.1	203	62.0	–24

f (MHz)	Z_{source} (Ω)	Z_{in} (Ω)	Max Drain Efficiency					
			P3dB					
			$Z_{load}^{(2)}$ (Ω)	Gain (dB)	(dBm)	(W)	η_D (%)	AM/PM ($^\circ$)
1805	1.66 – j6.38	1.38 + j7.43	2.15 – j2.96	17.7	53.9	247	69.4	–32
1840	2.64 – j7.07	1.93 + j8.02	2.37 – j3.17	17.6	54.1	256	68.9	–30
1880	2.30 – j7.54	2.01 + j8.60	2.52 – j3.41	17.9	54.0	250	67.1	–30

(1) Load impedance for optimum P1dB efficiency.

(2) Load impedance for optimum P3dB efficiency.

Z_{source} = Measured impedance presented to the input of the device at the package reference plane.

Z_{in} = Impedance as measured from gate contact to ground.

Z_{load} = Measured impedance presented to the output of the device at the package reference plane.

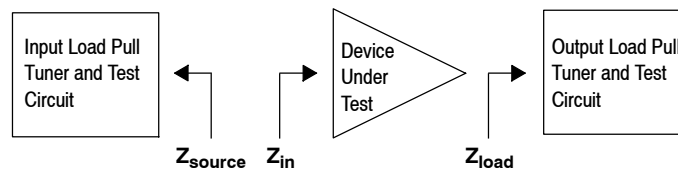

P1dB – TYPICAL PEAKING SIDE LOAD PULL CONTOURS — 1840 MHz

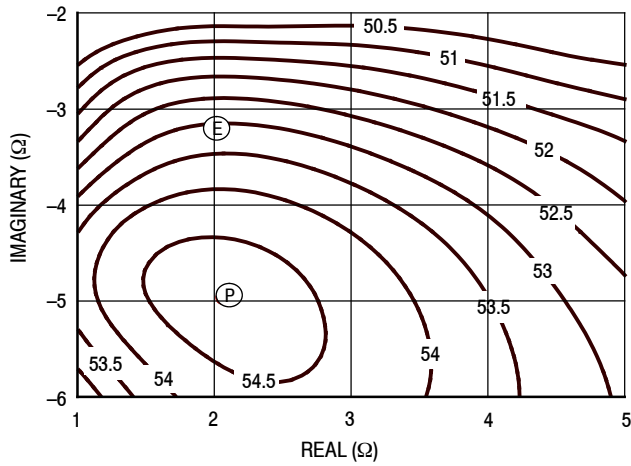

Figure 16. P1dB Load Pull Output Power Contours (dBm)

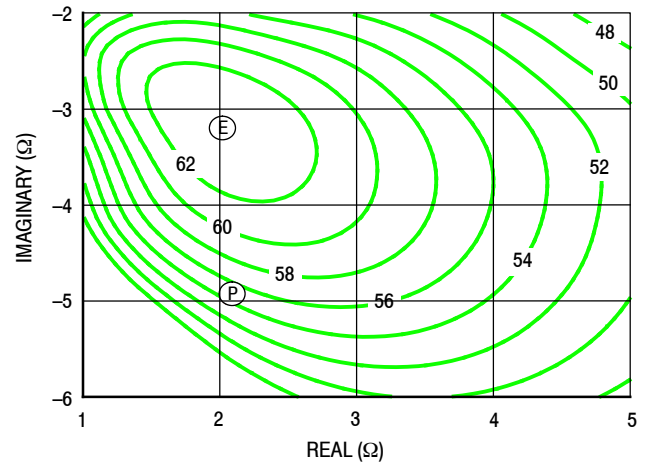

Figure 17. P1dB Load Pull Efficiency Contours (%)

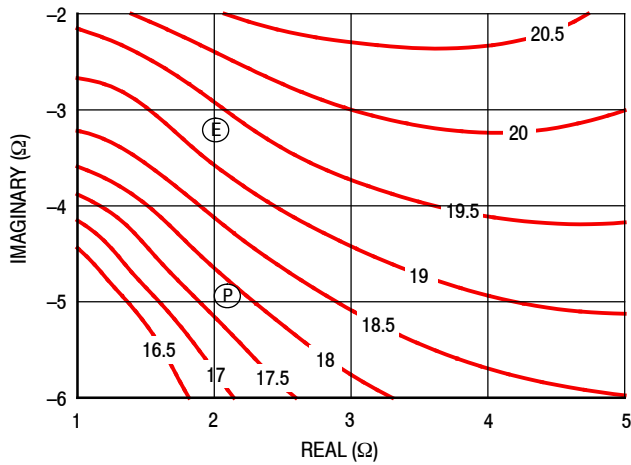

Figure 18. P1dB Load Pull Gain Contours (dB)

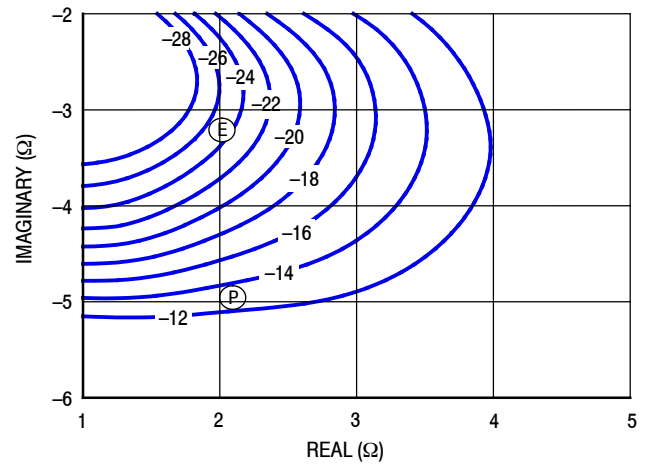

Figure 19. P1dB Load Pull AM/PM Contours (°)

NOTE: (P) = Maximum Output Power
(E) = Maximum Drain Efficiency

- Gain
- Drain Efficiency
- Linearity
- Output Power

P3dB – TYPICAL PEAKING SIDE LOAD PULL CONTOURS — 1840 MHz

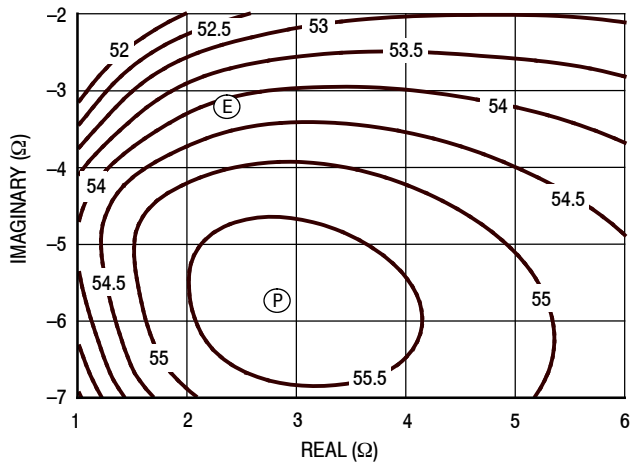

Figure 20. P3dB Load Pull Output Power Contours (dBm)

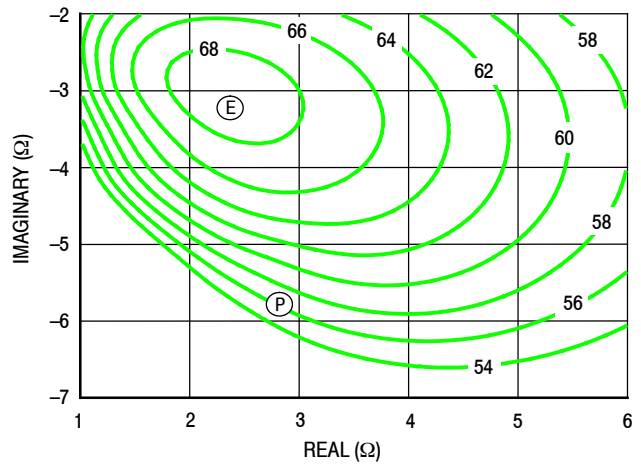

Figure 21. P3dB Load Pull Efficiency Contours (%)

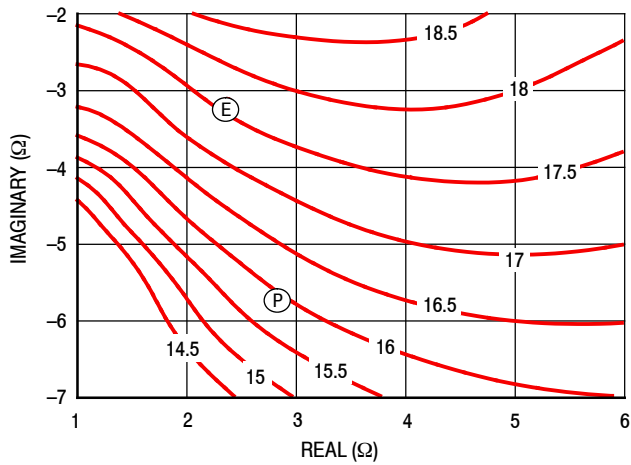

Figure 22. P3dB Load Pull Gain Contours (dB)

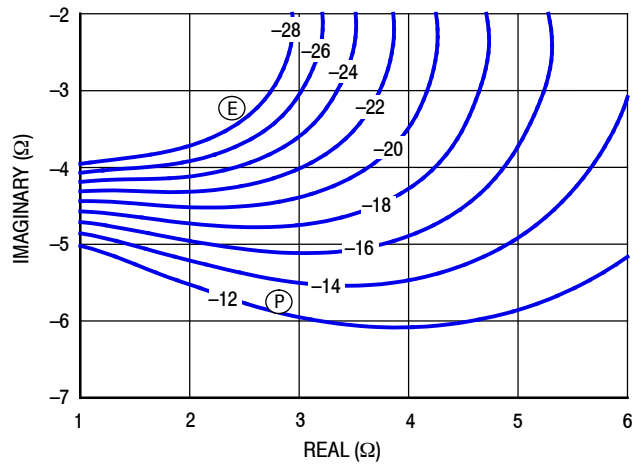

Figure 23. P3dB Load Pull AM/PM Contours (°)

NOTE: (P) = Maximum Output Power
(E) = Maximum Drain Efficiency

- Gain
- Drain Efficiency
- Linearity
- Output Power

P3dB LOAD PULL PERFORMANCE, CARRIER — 1800–2200 MHz

Table 11. Carrier Side Load Pull Performance — Maximum Power Tuning

$V_{DD} = 48$ Vdc, $I_{DQA} = 250$ mA, Pulsed CW, 10 μ sec(on), 10% Duty Cycle

f (MHz)	Z_{source} (Ω)	Z_{in} (Ω)	Max Output Power				
			P3dB				
			$Z_{load}^{(1)}$ (Ω)	Gain (dB)	(dBm)	η_D (%)	AM/PM ($^\circ$)
1800	2.56 – j6.80	2.60 + j6.70	5.40 – j8.08	16.2	54.2	65.1	–11
1840	3.20 – j7.30	3.00 + j7.10	5.30 – j8.38	16.2	54.1	63.9	–12
1880	3.90 – j7.70	3.50 + j7.40	5.88 – j9.20	16.2	54.0	62.5	–12
1930	3.90 – j7.70	4.10 + j7.78	6.00 – j9.40	16.4	54.0	63.2	–13
1990	5.60 – j7.11	5.30 + j7.70	6.60 – j9.80	16.6	54.0	64.0	–13
2110	7.80 – j5.70	7.10 + j5.70	6.50 – j10.8	16.5	53.9	64.2	–15
2200	7.50 – j1.70	6.30 + j2.90	7.04 – j12.0	16.2	53.8	59.4	–15

(1) Load impedance for optimum P3dB power.

Z_{source} = Measured impedance presented to the input of the device at the package reference plane.

Z_{in} = Impedance as measured from gate contact to ground.

Z_{load} = Measured impedance presented to the output of the device at the package reference plane.

Table 12. Carrier Side Load Pull Performance — Maximum Efficiency Tuning

$V_{DD} = 48$ Vdc, $I_{DQA} = 250$ mA, Pulsed CW, 10 μ sec(on), 10% Duty Cycle

f (MHz)	Z_{source} (Ω)	Z_{in} (Ω)	Max Drain Efficiency				
			P3dB				
			$Z_{load}^{(1)}$ (Ω)	Gain (dB)	(dBm)	η_D (%)	AM/PM ($^\circ$)
1800	2.56 – j6.80	2.20 + j7.20	3.93 – j4.40	17.5	52.6	75.4	–29
1840	3.20 – j7.30	2.60 + j7.70	4.00 – j4.50	17.6	52.4	74.3	–29
1880	3.90 – j7.70	3.30 + j8.10	4.50 – j5.00	17.7	52.5	72.2	–27
1930	3.90 – j7.70	3.90 + j8.70	4.30 – j5.30	17.7	52.4	71.7	–29
1990	5.60 – j7.11	5.38 + j8.80	4.46 – j5.90	17.8	52.4	72.7	–27
2110	7.80 – j5.70	8.20 + j6.00	5.10 – j7.40	17.7	53.0	72.9	–26
2200	7.50 – j1.70	6.80 + j2.30	5.60 – j8.40	17.5	53.0	68.5	–24

(1) Load impedance for optimum P3dB efficiency.

Z_{source} = Measured impedance presented to the input of the device at the package reference plane.

Z_{in} = Impedance as measured from gate contact to ground.

Z_{load} = Measured impedance presented to the output of the device at the package reference plane.

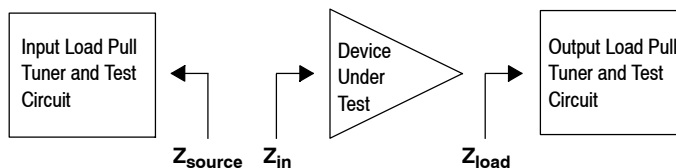

P3dB LOAD PULL PERFORMANCE, PEAKING — 1800–2200 MHz

Table 13. Peaking Side Load Pull Performance — Maximum Power Tuning

$V_{DD} = 48$ Vdc, $I_{DQB} = 350$ mA, Pulsed CW, 10 μ sec(on), 10% Duty Cycle

f (MHz)	Z_{source} (Ω)	Z_{in} (Ω)	Max Output Power				
			P3dB				
			$Z_{load}^{(1)}$ (Ω)	Gain (dB)	(dBm)	η_D (%)	AM/PM (°)
1800	2.56 – j6.80	2.20 + j6.30	2.90 – j5.90	15.6	55.7	62.9	–7
1880	2.80 – j6.90	2.83 + j7.00	2.90 – j6.10	16.1	55.5	62.8	–9
1930	3.00 – j7.16	3.50 + j7.00	3.53 – j7.50	15.7	55.5	57.1	–7
1990	4.50 – j7.10	4.20 + j6.90	3.10 – j6.93	16.2	55.6	61.4	–9
2110	4.80 – j4.70	4.50 + j4.80	3.00 – j7.60	16.5	55.7	61.3	–10
2200	4.20 – j3.00	3.01 + j3.70	3.10 – j8.20	16.5	55.6	59.6	–12

(1) Load impedance for optimum P3dB power.

Z_{source} = Measured impedance presented to the input of the device at the package reference plane.

Z_{in} = Impedance as measured from gate contact to ground.

Z_{load} = Measured impedance presented to the output of the device at the package reference plane.

Table 14. Peaking Side Load Pull Performance — Maximum Efficiency Tuning

$V_{DD} = 48$ Vdc, $I_{DQB} = 350$ mA, Pulsed CW, 10 μ sec(on), 10% Duty Cycle

f (MHz)	Z_{source} (Ω)	Z_{in} (Ω)	Max Drain Efficiency				
			P3dB				
			$Z_{load}^{(1)}$ (Ω)	Gain (dB)	(dBm)	η_D (%)	AM/PM (°)
1800	2.56 – j6.80	1.99 + j6.80	2.30 – j3.50	17.2	54.1	73.7	–26
1880	2.80 – j6.90	2.80 + j7.60	2.40 – j4.20	17.5	54.1	70.3	–26
1930	3.00 – j7.16	3.80 + j7.80	2.80 – j4.40	17.8	54.2	69.7	–25
1990	4.50 – j7.10	4.90 + j7.50	2.40 – j4.60	17.9	54.1	70.7	–27
2110	4.80 – j4.70	5.00 + j3.80	2.30 – j5.30	18.4	54.2	71.3	–30
2200	4.20 – j3.00	2.60 + j3.30	2.60 – j6.10	18.5	54.5	68.8	–28

(1) Load impedance for optimum P3dB efficiency.

Z_{source} = Measured impedance presented to the input of the device at the package reference plane.

Z_{in} = Impedance as measured from gate contact to ground.

Z_{load} = Measured impedance presented to the output of the device at the package reference plane.

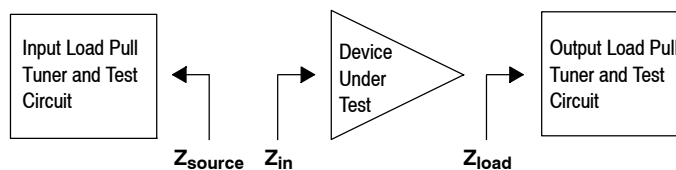

PACKAGE INFORMATION

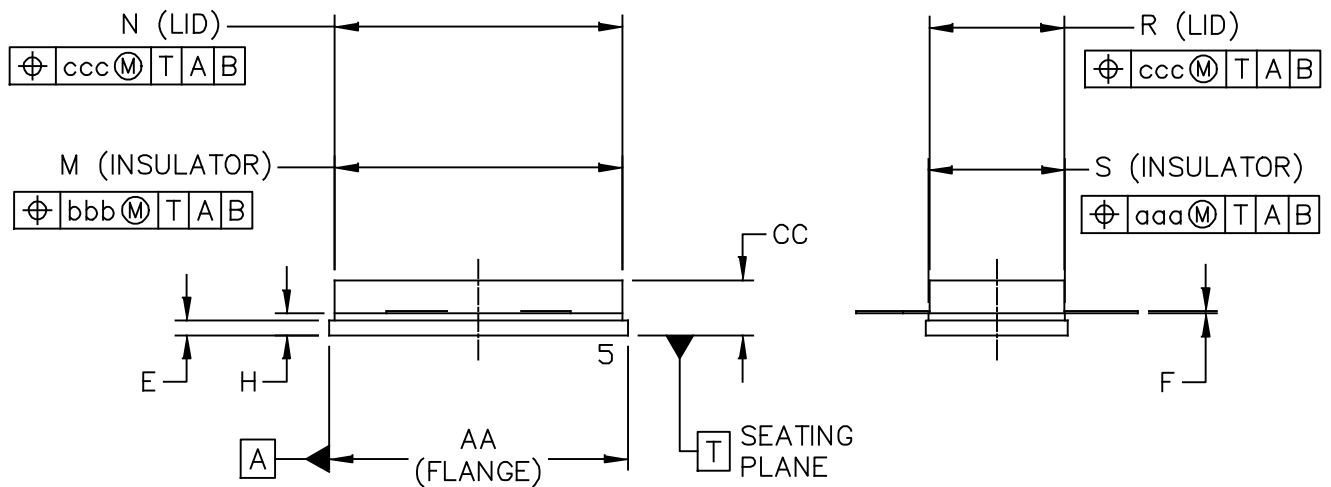
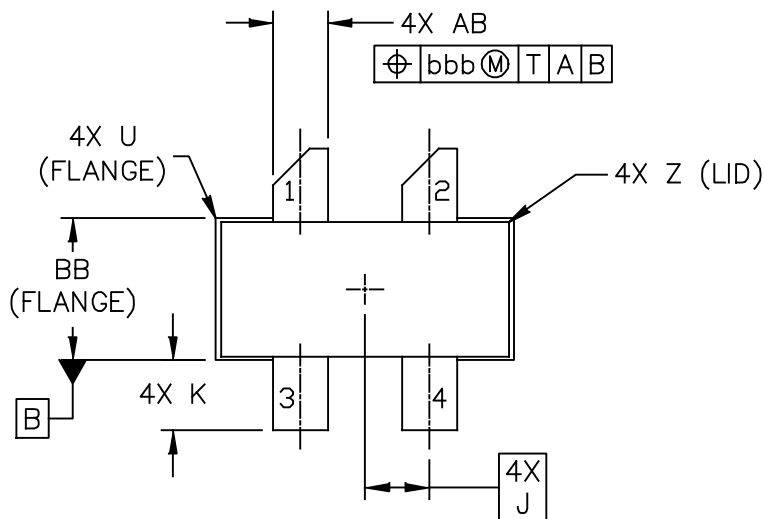

© NXP SEMICONDUCTORS N.V. ALL RIGHTS RESERVED	MECHANICAL OUTLINE	PRINT VERSION NOT TO SCALE
TITLE: NI-780S-4L	DOCUMENT NO: 98ASA10718D	REV: C
	STANDARD: NON-JEDEC	
	SOT1826-1	01 AUG 2016

NOTES:

1. DIMENSIONING AND TOLERANCING PER ANSI Y14.5M-1994.
2. CONTROLLING DIMENSION: INCH.
3. DELETED
4. DIMENSION H IS MEASURED .030 (0.762) AWAY FROM FLANGE TO CLEAR EPOXY FLOW OUT PARALLEL TO DATUM B.

DIM	INCH		MILLIMETER		DIM	INCH		MILLIMETER	
	MIN	MAX	MIN	MAX		MIN	MAX	MIN	MAX
AA	.805	.815	20.45	20.70	U		.040		1.02
BB	.382	.388	9.70	9.86	Z		.030		0.76
CC	.125	.170	3.18	4.32	AB	.145	.155	3.68	- 3.94
E	.035	.045	0.89	1.14					
F	.003	.006	0.08	0.15	aaa		.005		0.127
H	.057	.067	1.45	1.70	bbb		.010		0.254
J	.175 BSC		4.44 BSC		ccc		.015		0.381
K	.170	.210	4.32	5.33					
M	.774	.786	19.61	20.02					
N	.772	.788	19.61	20.02					
R	.365	.375	9.27	9.53					
S	.365	.375	9.27	9.52					
© NXP SEMICONDUCTORS N. V. ALL RIGHTS RESERVED			MECHANICAL OUTLINE			PRINT VERSION NOT TO SCALE			
TITLE: NI-780S-4L					DOCUMENT NO: 98ASA10718D REV: C				
					STANDARD: NON-JEDEC				
					SOT1826-1			01 AUG 2016	

PRODUCT DOCUMENTATION, SOFTWARE AND TOOLS

Refer to the following resources to aid your design process.

Application Notes

- AN1908: Solder Reflow Attach Method for High Power RF Devices in Air Cavity Packages
- AN1955: Thermal Measurement Methodology of RF Power Amplifiers

Software

- .s2p File

Development Tools

- Printed Circuit Boards

REVISION HISTORY

The following table summarizes revisions to this document.

Revision	Date	Description
0	May 2017	<ul style="list-style-type: none">• Initial release of data sheet
1	Aug. 2020	<ul style="list-style-type: none">• Changed upper frequency range from 1880 MHz to 2200 MHz to highlight part performance up to 2200 MHz, p. 1• Biasing sequence note: updated to reflect latest biasing sequence recommendations, p. 3• Tables 11–14, Load Pull Performance: added Carrier Side and Peaking Side load pull performance tables showing P3dB performance across the 1800–2200 MHz band, pp. 13–14

How to Reach Us:

Home Page:
nxp.com

Web Support:
nxp.com/support

Information in this document is provided solely to enable system and software implementers to use NXP products. There are no express or implied copyright licenses granted hereunder to design or fabricate any integrated circuits based on the information in this document. NXP reserves the right to make changes without further notice to any products herein.

NXP makes no warranty, representation, or guarantee regarding the suitability of its products for any particular purpose, nor does NXP assume any liability arising out of the application or use of any product or circuit, and specifically disclaims any and all liability, including without limitation consequential or incidental damages. "Typical" parameters that may be provided in NXP data sheets and/or specifications can and do vary in different applications, and actual performance may vary over time. All operating parameters, including "typicals," must be validated for each customer application by customer's technical experts. NXP does not convey any license under its patent rights nor the rights of others. NXP sells products pursuant to standard terms and conditions of sale, which can be found at the following address: nxp.com/SalesTermsandConditions.

NXP, the NXP logo, and Airfast are trademarks of NXP B.V. All other product or service names are the property of their respective owners.

© 2017, 2020 NXP B.V.

