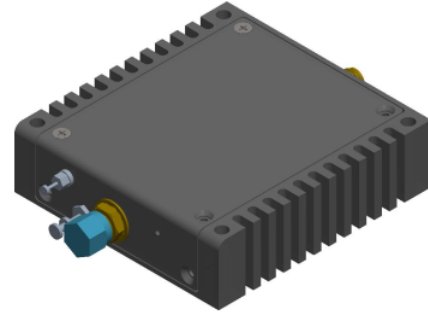
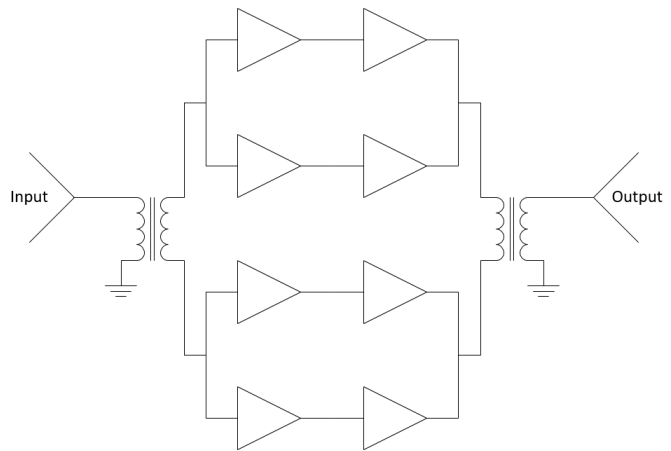

20-6000 MHz High Gain Balanced Amplifier

The Spectrolite product line leverages Silver Palm Technologies' field-proven proprietary designs into compact modules for military, commercial, and laboratory use. The high-dynamic range balanced amplifiers used in the Spectrolite products were conceived out of the need for RF performance not previously achievable with off-the-shelf components. The SPEC-A11ES-1 is a two-stage amplifier that offers excellent performance within the HF to SHF bands. High gain, great second-and third-order intercept points, and low noise figure makes the SPEC-A11ES-1 an excellent amplifier for any high-dynamic range RF chain.

**SPEC-A11ES-1****SPEC-A11ES-1 Electrical Schematic****Features**

- High IP3
- Excellent Second-Order Performance
- Low Noise
- Low Power

Applications

- Base Station infrastructure
- Portable Wireless
- LTE

Electrical Specifications

All measurements are made at +25 °C unless otherwise noted.

Table 1: Specifications

Parameter	Symbol	Min.	Typ.	Max.	Unit
Frequency	<i>Freq.</i>	20	–	6000	MHz
Gain	<i>S₂₁</i>	–	23.5	–	dB
Noise Figure	<i>NF</i>	–	4.06	–	dB
Output Third-Order Intercept	<i>OIP₃</i>	–	+35	–	dBm
Output Second-Order Intercept	<i>OIP₂</i>	–	+65	–	dBm
Output Power at 1dB Compression	<i>P1dB</i>	–	26.0	–	dBm
Input VSWR	<i>VSWR1</i>	–	1.29 : 1	–	–
Output VSWR	<i>VSWR2</i>	–	1.40 : 1	–	–
Dimensions	–	–	2.5" x 2.6" x .71"	–	in
Weight	–	–	.25	–	lbs
Power	–	–	3.36	–	Watts
Current at +5.5V	–	–	.611	–	Amps
Supply Voltage	–	+5.5	–	+16	Volts

Absolute Maximum Ratings Without Damage

Stresses above those listed under Absolute Maximum Ratings will cause permanent damage to the module.

Table 2: Absolute Maximum Ratings

Parameter	Rating
Storage Temperature	-65 to +150 °C
Operational Temperature	-40 to +70 °C
Supply Voltage	+20V
Maximum Continuous RF Input Power	+26dBm

Typical Performance Data

All measurements are made at +25 °C unless otherwise noted.

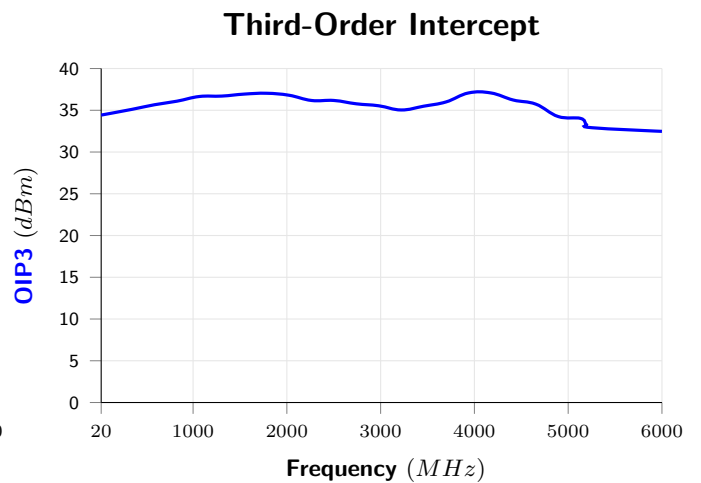
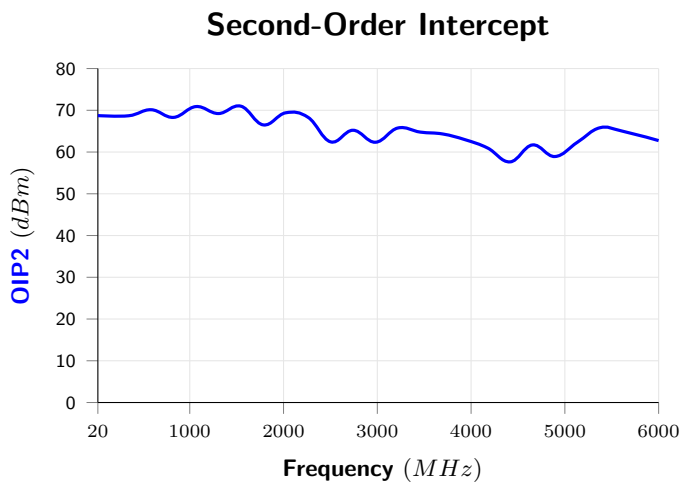
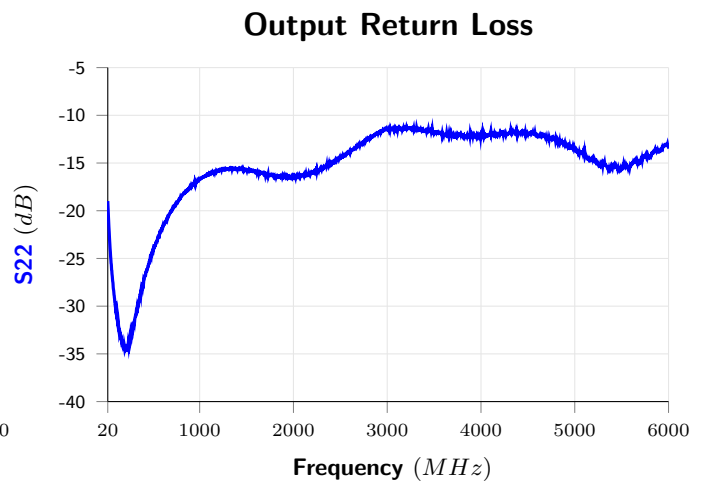
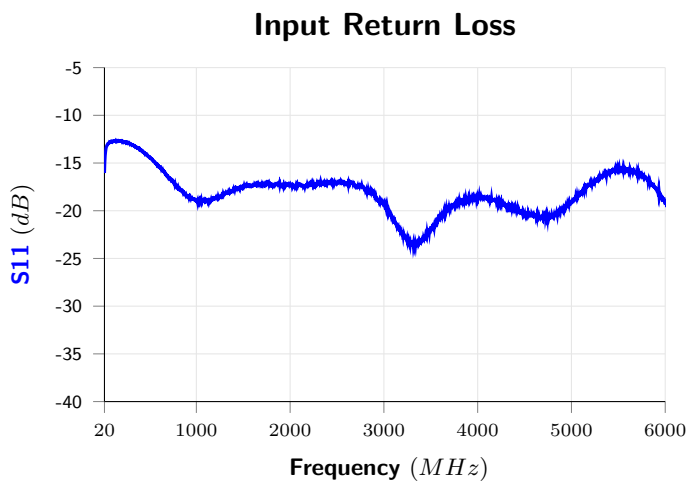
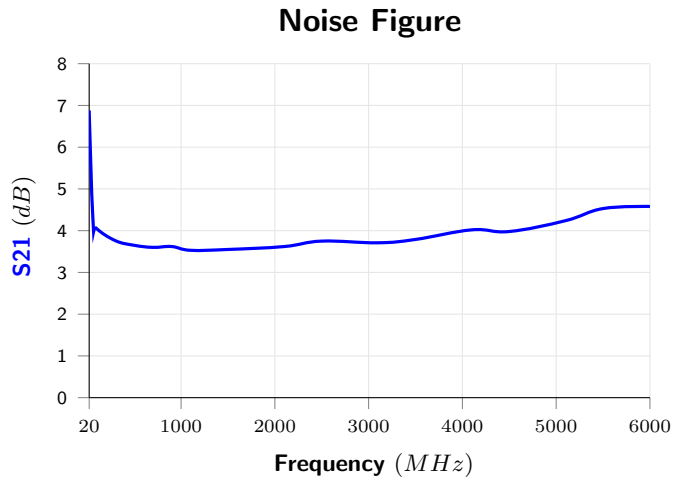
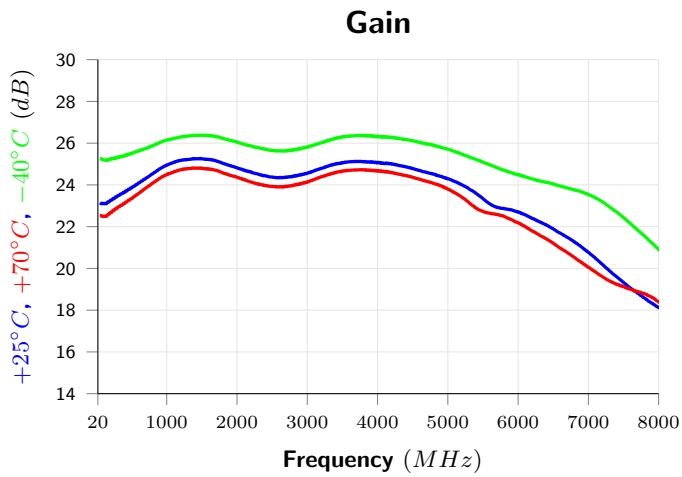

Product Dimensions

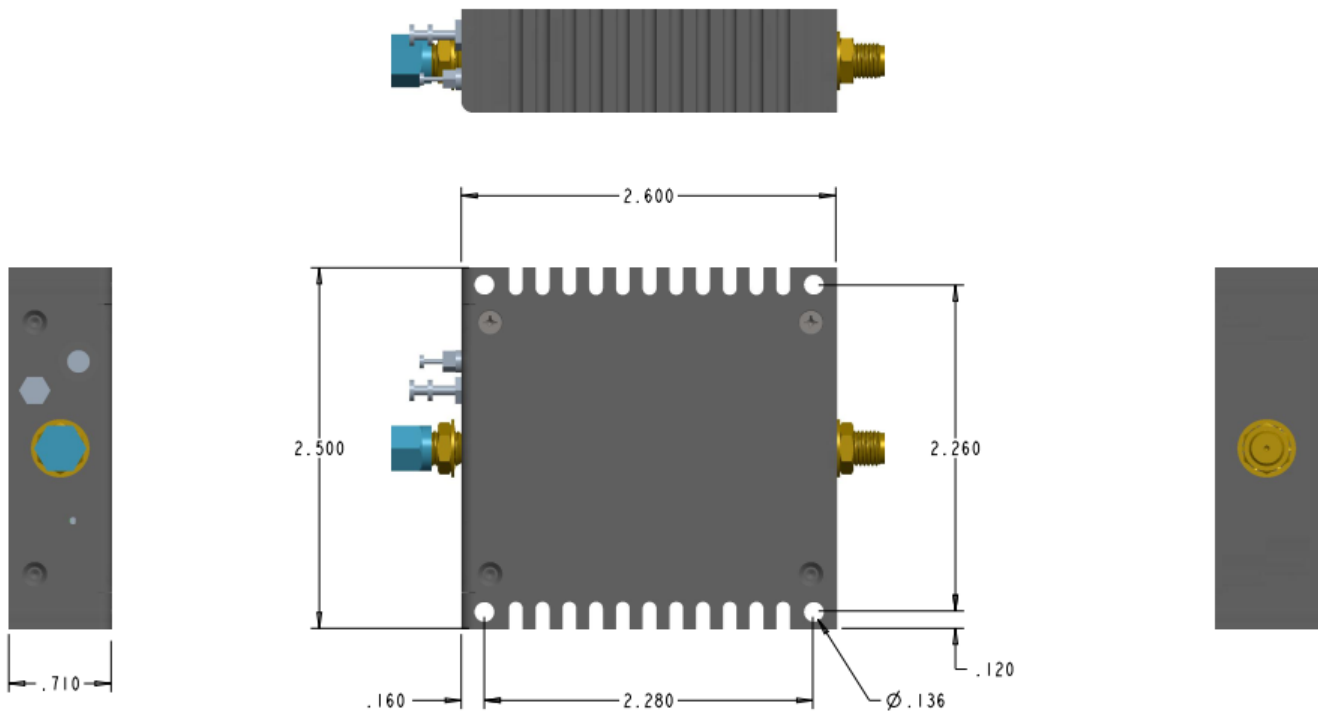

Ordering Options

We offer RoHS compliant and RoHS non-compliant options.

Spectrolite Product Number	RoHS
SPEC-A11ES-1	RoHS Non-Compliant
SPEC-A11ES-1#PBF	RoHS Compliant