



Main

Range of Product	Telemecanique Photoelectric sensors XU
Series name	Application material handling
Electronic sensor type	Photo-electric sensor
Sensor name	XUY
Sensor design	Compact
Detection system	Diffuse with background suppression
Material	Plastic
Type of output signal	Discrete
Supply circuit type	DC
Wiring Technique	4-wire
Discrete output type	PNP and NPN
Discrete output function	1 NO or 1 NC programmable
Electrical connection	1 male connector M8, 4 pins
Product Specific Application	Control of filling 2 channels triangulation Detection of object on conveyor against reflective background
Emission	Infrared LED, modulated
[Sn] nominal sensing distance	1.97...23.62 in (50...600 mm)

Complementary

Enclosure Material	Glass impregnated nylon
Output Type	Solid state
Status LED	Output state 1 LED green)
[Us] rated supply voltage	12...24 V DC reverse polarity protection
Supply voltage limits	10...30 V DC
Switching capacity in mA	100 mA (overload and short-circuit protection)
Switching frequency	> 370 Hz
Maximum voltage drop	<2 V (closed state)
Current consumption	< 1.5 mA no-load
Maximum delay response	1.8 ms
Maximum delay recovery	1.8 ms
Net Weight	0.12 lb(US) (0.055 kg)

Environment

Product Certifications	CE
Ambient Air Temperature for Operation	32...122 °F (0...50 °C)
Ambient Air Temperature for Storage	-4...140 °F (-20...60 °C)
Immunity to ambient light	10000 Lux natural light 1300 lux incandescent bulb
IP degree of protection	IP65 IEC 60529

The information provided in this documentation contains general descriptions and/or technical characteristics of the performance of the products contained herein. This documentation is not intended as a substitute for and is not to be used for determining suitability or reliability of these products for specific user applications. It is the duty of any such user or integrator to perform the appropriate and complete risk analysis, evaluation and testing of the products with respect to the relevant specific application or use thereof. Neither Schneider Electric Industries SAS nor any of its affiliates or subsidiaries shall be responsible or liable for misuse of the information contained herein.

Ordering and shipping details

Category	22481-SENSORS, PHOTOELECTRIC
Discount Schedule	DS2
GTIN	3389119007269
Nbr. of units in pkg.	1
Package weight(Lbs)	2.79 oz (79.0 g)
Returnability	No
Country of origin	FR

Packing Units

Unit Type of Package 1	PCE
Package 1 Height	1.42 in (3.6 cm)
Package 1 width	2.80 in (7.1 cm)
Package 1 Length	5.12 in (13 cm)
Unit Type of Package 2	S01
Number of Units in Package 2	15
Package 2 Weight	3.08 lb(US) (1.398 kg)
Package 2 Height	5.91 in (15 cm)
Package 2 width	5.91 in (15 cm)
Package 2 Length	15.75 in (40 cm)

Offer Sustainability

California proposition 65	WARNING: This product can expose you to chemicals including: Diisononyl phthalate (DINP), which is known to the State of California to cause cancer, and Di-isodecyl phthalate (DIDP), which is known to the State of California to cause birth defects or other reproductive harm. For more information go to www.P65Warnings.ca.gov
REACH Regulation	REACH Declaration
EU RoHS Directive	Pro-active compliance (Product out of EU RoHS legal scope) EU RoHS Declaration
Mercury free	Yes
RoHS exemption information	Yes

Contractual warranty

Warranty	18 months
----------	-----------

Dimensions

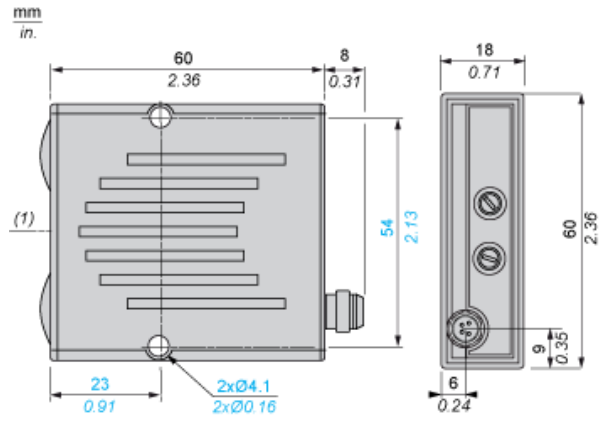

(1) Optical axis

Mounting and Clearance

Two independent sensors with triangulation: A, B

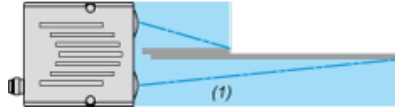

(1) Detected zones

Immunity to reflection: A and B

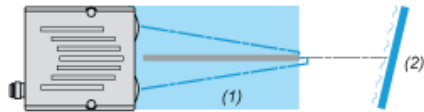

(1) Detected zones
(2) Mirror

Detection of contrasting objects: A or B

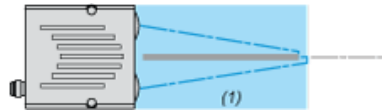

(1) Detected zones

Monitoring of distance: A xor B

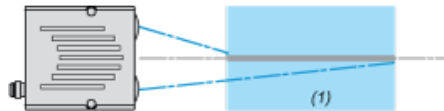

(1) Detected zones

Wiring Schemes and Outputs

Two Independent Sensors with Triangulation: A, B

NO Output

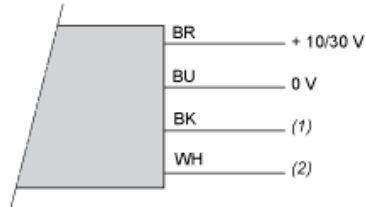

NC Output

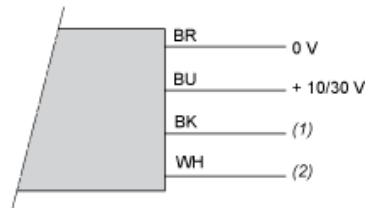

- BN : Brown
- BU : Blue
- BK : Black
- WH : White
- (1) Zone A output
- (2) Zone B output

Immunity to Reflection: A and B

Without Time Delay

NO Output

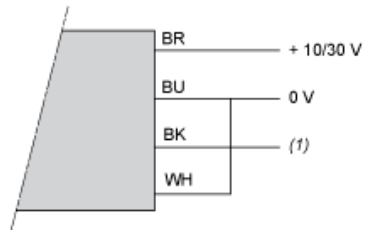

NC Output

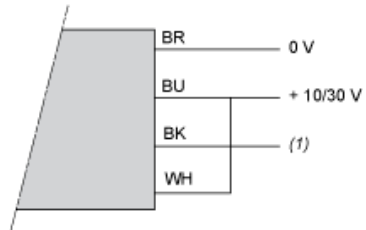

- BN : Brown
 - BU : Blue
 - BK : Black
 - WH : White
 - (1) Output
- With 40 ms Time Delay

NO Output

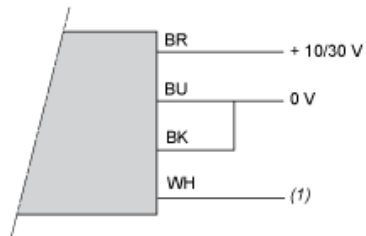

NC Output

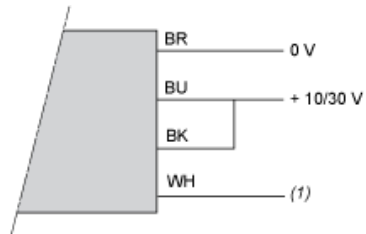

BN : Brown
BU : Blue
BK : Black
WH : White
(1) Output

Detection of Contrasting Objects: A or B

NO Output

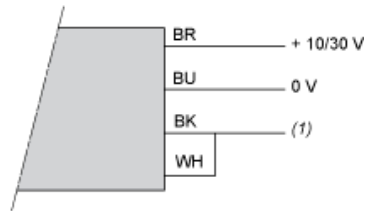

NC Output

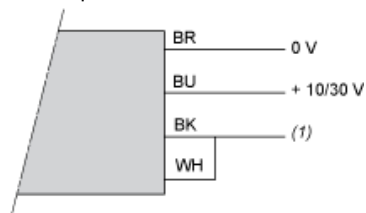

BN : Brown
BU : Blue
BK : Black
WH : White
(1) Output

Monitoring of Distance: A or B

Without Time Delay

NO Output

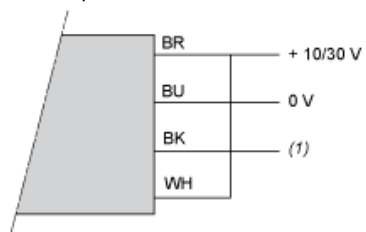

NC Output

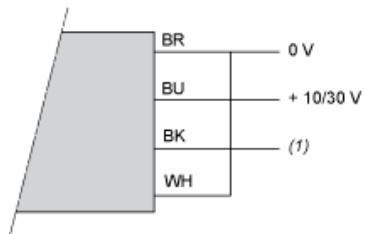

BN : Brown

BU : Blue

BK : Black

WH : White

(1) Output

With 40 ms Time Delay

NO Output

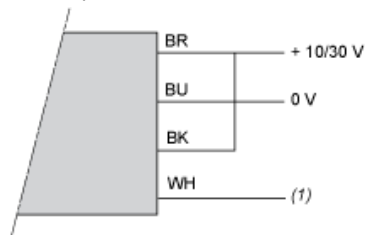

NC Output

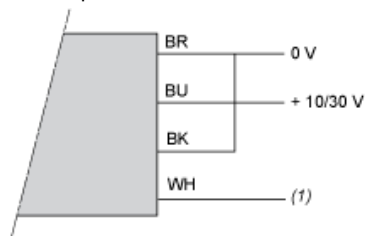

BN : Brown

BU : Blue

BK : Black

WH : White

(1) Output

Detection Curves

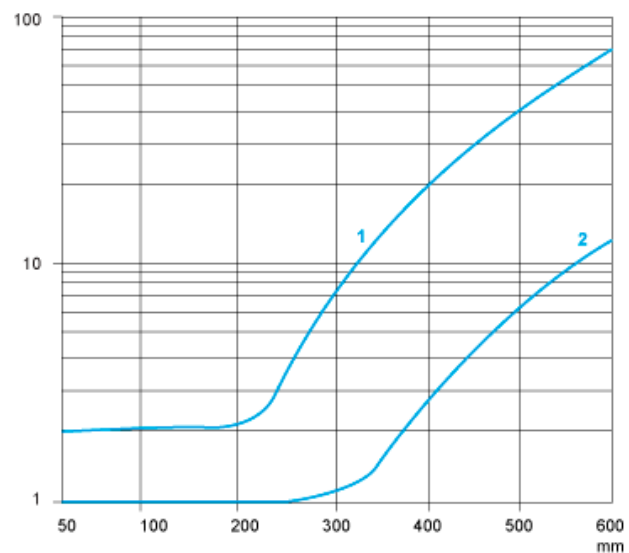

- 1 : Black 6%
- 2 : Grey 18% - Distance (mm) set on 92% (Kodak 1527795)