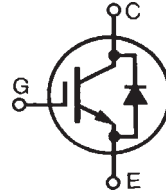


# HiPerFAST™ IGBT IXGH 40N60B2D1 IXGT 40N60B2D1

Optimized for 10-25 KHz hard switching and up to 150 KHz resonant switching

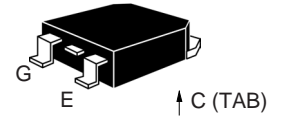
Preliminary Data Sheet



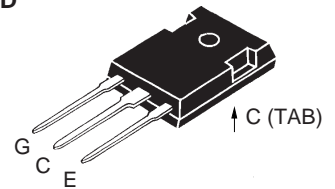
$$\begin{aligned} V_{CES} &= 600 \text{ V} \\ I_{C25} &= 75 \text{ A} \\ V_{CE(sat)} &< 1.7 \text{ V} \\ t_{fi typ} &= 82 \text{ ns} \end{aligned}$$

Symbol	Test Conditions	Maximum Ratings	
$V_{CES}$	$T_J = 25^\circ\text{C}$ to $150^\circ\text{C}$	600	V
$V_{CGR}$	$T_J = 25^\circ\text{C}$ to $150^\circ\text{C}$ ; $R_{GE} = 1 \text{ M}\Omega$	600	V
$V_{GES}$	Continuous	$\pm 20$	V
$V_{GEM}$	Transient	$\pm 30$	V
$I_{C25}$	$T_C = 25^\circ\text{C}$ (limited by leads)	75	A
$I_{C110}$	$T_C = 110^\circ\text{C}$	40	A
$I_{CM}$	$T_C = 25^\circ\text{C}$ , 1 ms	200	A
<b>SSOA</b> <b>(RBSOA)</b>	$V_{GE} = 15 \text{ V}$ , $T_{VJ} = 125^\circ\text{C}$ , $R_G = 10 \Omega$ Clamped inductive load @ $\leq 600 \text{ V}$	$I_{CM} = 80$	A
$P_C$	$T_C = 25^\circ\text{C}$	300	W
$T_J$		-55 ... +150	$^\circ\text{C}$
$T_{JM}$		150	$^\circ\text{C}$
$T_{stg}$		-55 ... +150	$^\circ\text{C}$
Maximum lead temperature for soldering 1.6 mm (0.062 in.) from case for 10 s		300	$^\circ\text{C}$
$M_d$	Mounting torque (M3)	1.13/10 Nm/lb.in.	
<b>Weight</b>	TO-247 AD	6	g
	TO-268 SMD	4	g

TO-268  
(IXGT)



TO-247 AD  
(IXGH)



G = Gate, C = Collector,  
E = Emitter, TAB = Collector

## Features

- Medium frequency IGBT
- Square RBSOA
- High current handling capability
- MOS Gate turn-on  
- drive simplicity

## Applications

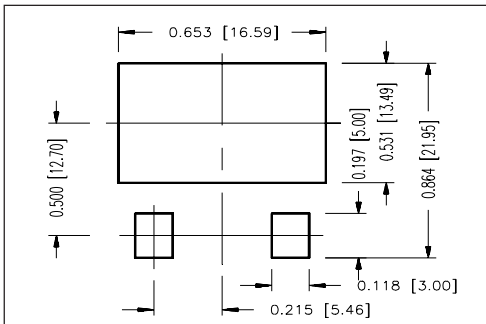
- PFC circuits
- Uninterruptible power supplies (UPS)
- Switched-mode and resonant-mode power supplies
- AC motor speed control
- DC servo and robot drives
- DC choppers

Symbol	Test Conditions	Characteristic Values ( $T_J = 25^\circ\text{C}$ , unless otherwise specified)		
		min.	typ.	max.
$V_{GE(th)}$	$I_C = 250 \mu\text{A}$ , $V_{CE} = V_{GE}$	3.0		5.0 V
$I_{CES}$	$V_{CE} = V_{CES}$ $V_{GE} = 0 \text{ V}$			50 $\mu\text{A}$ 1 mA
$I_{GES}$	$V_{CE} = 0 \text{ V}$ , $V_{GE} = \pm 20 \text{ V}$			$\pm 100 \text{ nA}$
$V_{CE(sat)}$	$I_C = 30 \text{ A}$ , $V_{GE} = 15 \text{ V}$			1.7 V

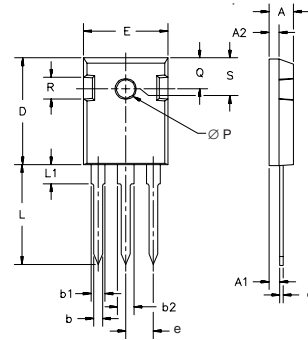
Symbol	Test Conditions	Characteristic Values ( $T_J = 25^\circ\text{C}$ , unless otherwise specified)			
		min.	typ.	max.	
$g_{fs}$	$I_C = 30\text{ A}; V_{CE} = 10\text{ V}$ , Pulse test, $t \leq 300\ \mu\text{s}$ , duty cycle $\leq 2\%$	20	36	S	
$C_{ies}$ $C_{oes}$ $C_{res}$	$V_{CE} = 25\text{ V}, V_{GE} = 0\text{ V}, f = 1\text{ MHz}$		2560	pF	
			210	pF	
			54	pF	
$Q_g$ $Q_{ge}$ $Q_{gc}$	$I_C = 30\text{ A}, V_{GE} = 15\text{ V}, V_{CE} = 300\text{ V}$		100	nC	
			15	nC	
			36	nC	
$t_{d(on)}$ $t_{ri}$ $t_{d(off)}$ $t_{fi}$ $E_{off}$	<b>Inductive load, <math>T_J = 25^\circ\text{C}</math></b> $I_C = 30\text{ A}, V_{GE} = 15\text{ V}$ $V_{CE} = 400\text{ V}, R_G = 3.3\ \Omega$		18	ns	
			20	ns	
			130	200	ns
			82	150	ns
			0.4	0.8	mJ
$t_{d(on)}$ $t_{ri}$ $E_{on}$ $t_{d(off)}$ $t_{fi}$ $E_{off}$	<b>Inductive load, <math>T_J = 125^\circ\text{C}</math></b> $I_C = 30\text{ A}, V_{GE} = 15\text{ V}$ $V_{CE} = 400\text{ V}, R_G = 3.3\ \Omega$		18	ns	
			20	ns	
			0.3	mJ	
			240	ns	
			150	ns	
			1.10	mJ	
$R_{thJC}$ $R_{thCK}$	(TO-247)		0.25	0.42 KW KW	

Symbol	Test Conditions	Characteristic Values ( $T_J = 25^\circ\text{C}$ , unless otherwise specified)		
		min.	typ.	max.
$V_F$	$I_F = 30\text{ A}, V_{GE} = 0\text{ V}$ , Pulse test $t \leq 300\ \mu\text{s}$ , duty cycle $d \leq 2\%$	$T_J = 150^\circ\text{C}$		1.6 V 2.5 V
$I_{RM}$ $t_{rr}$	$I_F = 30\text{ A}, V_{GE} = 0\text{ V}, -di_F/dt = 100\text{ A}/\mu\text{s}, T_J = 100^\circ\text{C}$ $V_R = 100\text{ V}, T_J = 100^\circ\text{C}$ $I_F = 1\text{ A}, -di/dt = 100\text{ A}/\mu\text{s}; V_R = 30\text{ V}$		100	4 A ns
			25	ns
$R_{thJC}$				0.9 KW

**Min. Recommended Footprint**

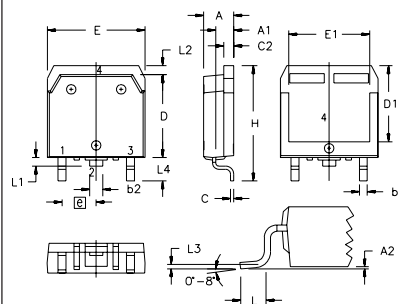


**TO-247 AD Outline**



Dim.	Millimeter		Inches	
	Min.	Max.	Min.	Max.
A	4.7	5.3	.185	.209
A <sub>1</sub>	2.2	2.54	.087	.102
A <sub>2</sub>	2.2	2.6	.059	.098
b	1.0	1.4	.040	.055
b <sub>1</sub>	1.65	2.13	.065	.084
b <sub>2</sub>	2.87	3.12	.113	.123
C	.4	.8	.016	.031
D	20.80	21.46	.819	.845
E	15.75	16.26	.610	.640
e	5.20	5.72	0.205	0.225
L	19.81	20.32	.780	.800
L1		4.50		.177
∅P	3.55	3.65	.140	.144
Q	5.89	6.40	0.232	0.252
R	4.32	5.49	.170	.216
S	6.15	BSC	.242	BSC

**TO-268 Outline**



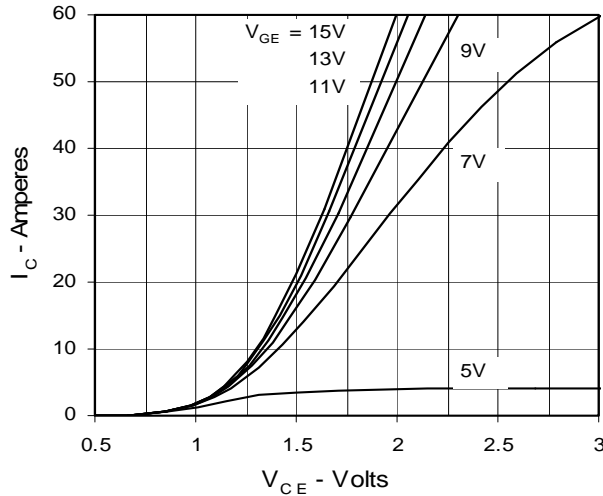
SYM	INCHES		MILLIMETERS	
	MIN	MAX	MIN	MAX
A	.193	.201	4.90	5.10
A1	.106	.114	2.70	2.90
A2	.001	.010	0.02	0.25
b	.045	.057	1.15	1.45
b2	.075	.083	1.90	2.10
C	.016	.026	0.40	0.65
C2	.057	.063	1.45	1.60
D	.543	.551	13.80	14.00
D1	.488	.500	12.40	12.70
E	.624	.632	15.85	16.05
E1	.524	.535	13.30	13.60
e	.215 BSC		5.45 BSC	
H	.736	.752	18.70	19.10
L	.094	.106	2.40	2.70
L1	.047	.055	1.20	1.40
L2	.039	.045	1.00	1.15
L3	.010 BSC		0.25 BSC	
L4	.150	.161	3.80	4.10

IXYS reserves the right to change limits, test conditions, and dimensions.

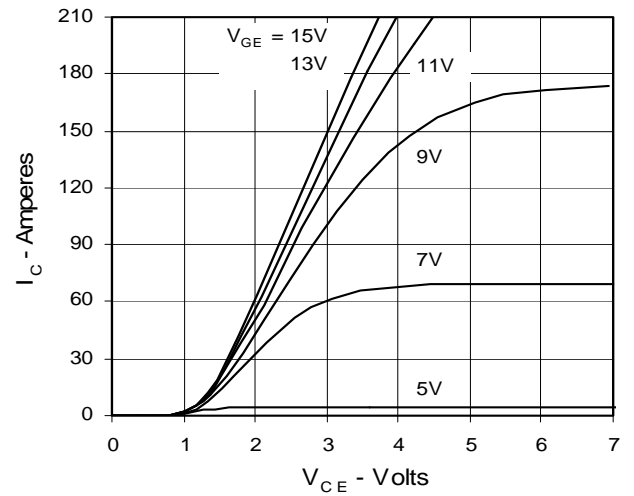
IXYS MOSFETs and IGBTs are covered by one or more of the following U.S. patents:

4,835,592 4,881,106 5,017,508 5,049,961 5,187,117 5,486,715 6,306,728B1 6,259,123B1 6,306,728B1  
4,850,072 4,931,844 5,034,796 5,063,307 5,237,481 5,381,025 6,404,065B1 6,162,665 6,534,343

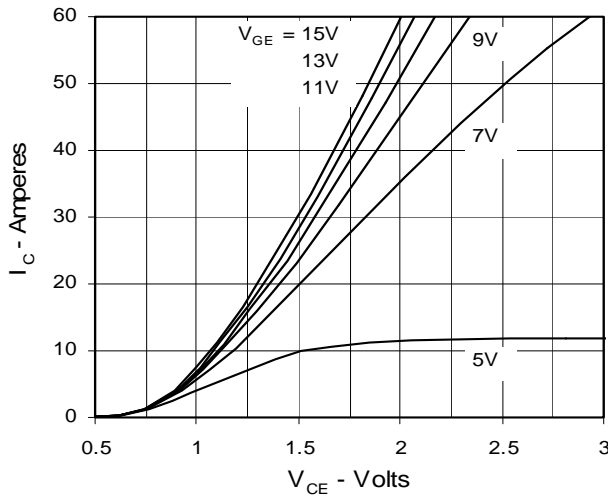
**Fig. 1. Output Characteristics  
@ 25 Deg. C**



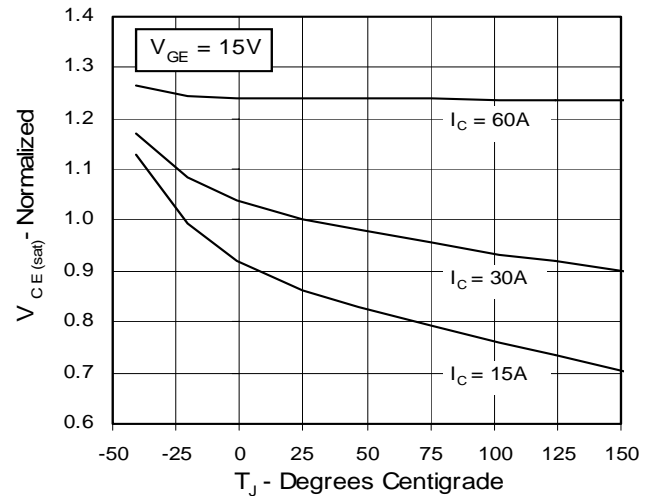
**Fig. 2. Extended Output Characteristics  
@ 25 deg. C**



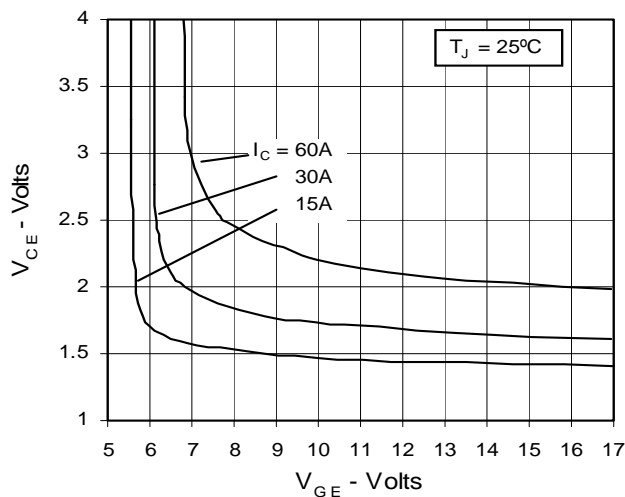
**Fig. 3. Output Characteristics  
@ 125 Deg. C**



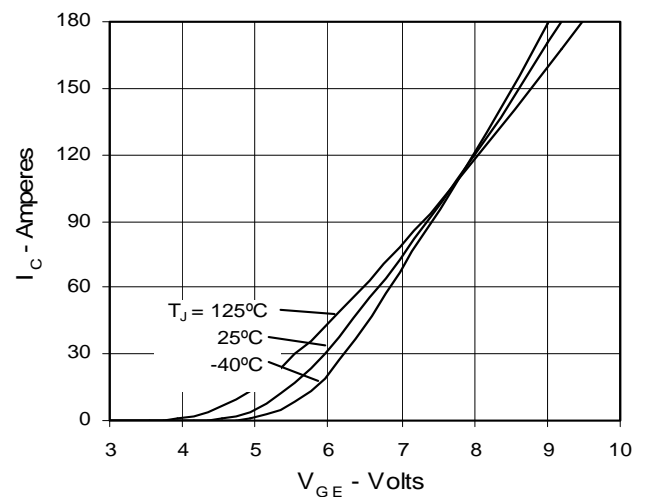
**Fig. 4. Dependence of  $V_{CE(sat)}$  on Temperature**



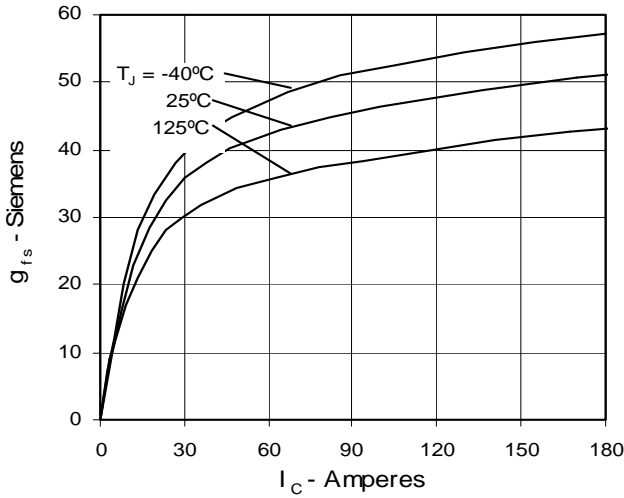
**Fig. 5. Collector-to-Emitter Voltage  
vs. Gate-to-Emitter voltage**



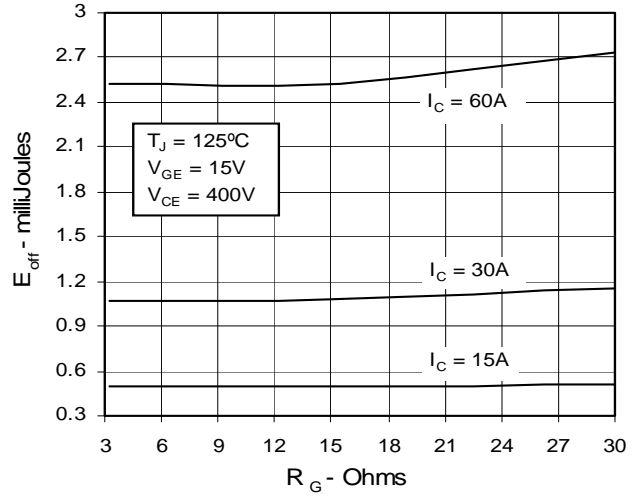
**Fig. 6. Input Admittance**



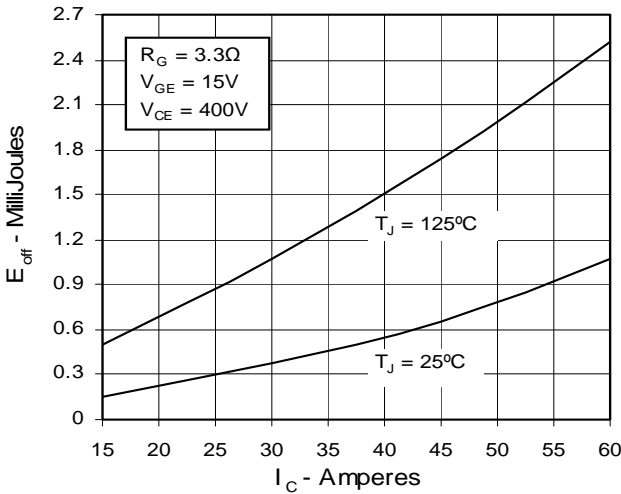
**Fig. 7. Transconductance**



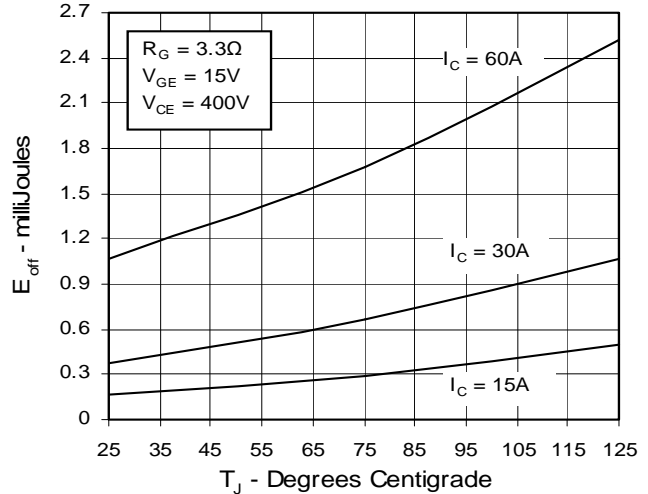
**Fig. 8. Dependence of Turn-Off Energy on  $R_G$**



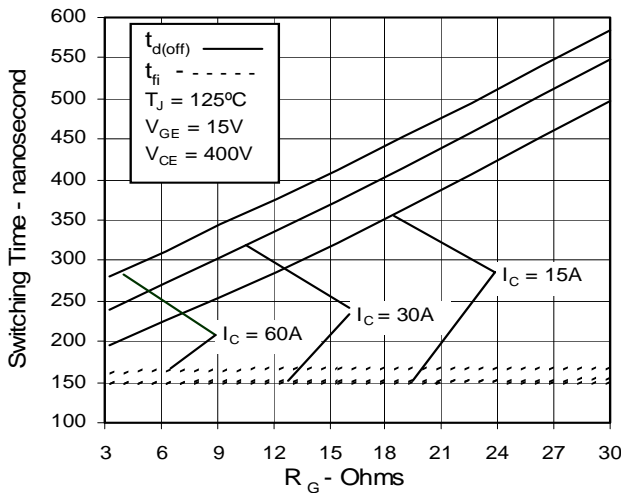
**Fig. 9. Dependence of Turn-Off Energy on  $I_C$**



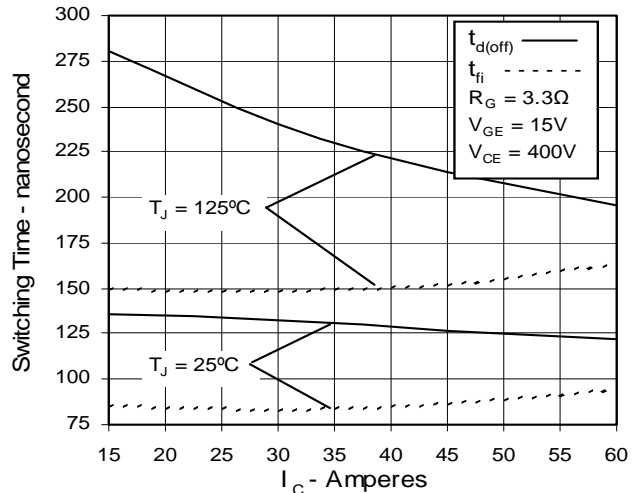
**Fig. 10. Dependence of Turn-Off Energy on Temperature**



**Fig. 11. Dependence of Turn-Off Switching Time on  $R_G$**

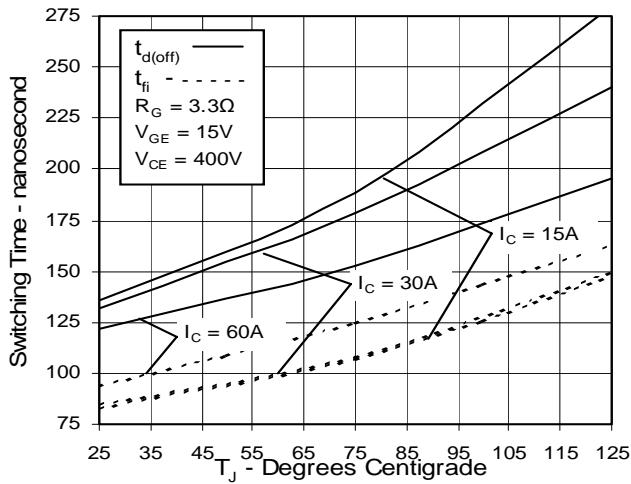


**Fig. 12. Dependence of Turn-Off Switching Time on  $I_C$**

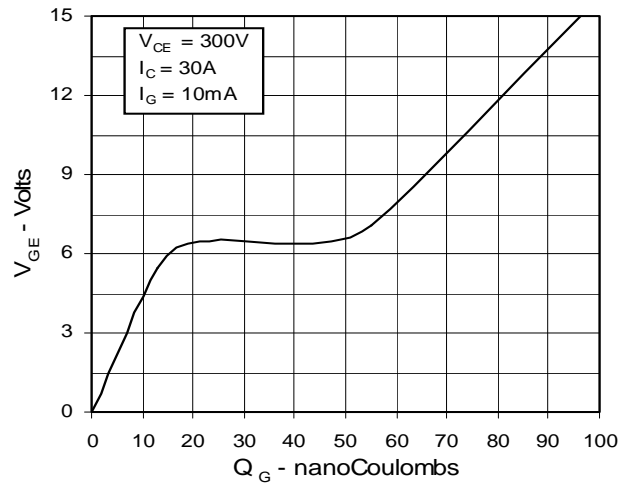


IXYS reserves the right to change limits, test conditions, and dimensions.

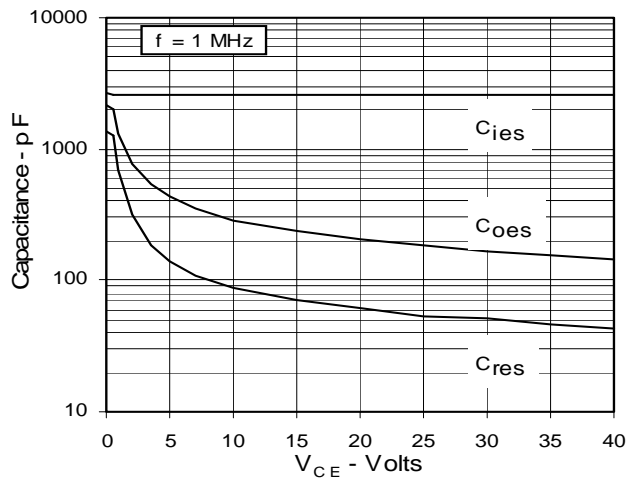
**Fig. 13. Dependence of Turn-Off Switching Time on Temperature**



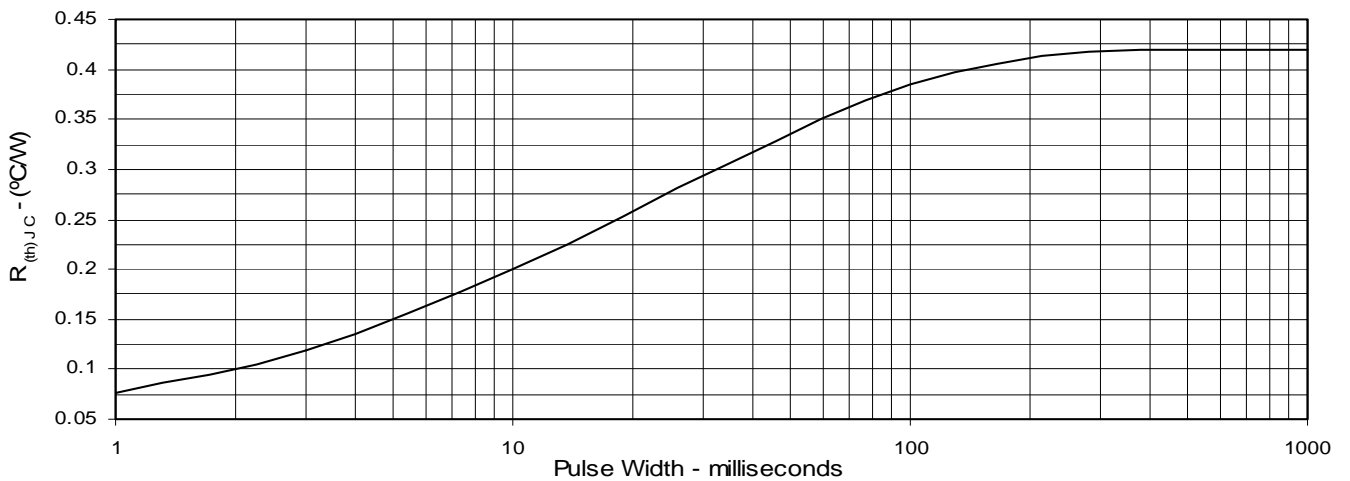
**Fig. 14. Gate Charge**



**Fig. 15. Capacitance**



**Fig. 16. Maximum Transient Thermal Resistance**



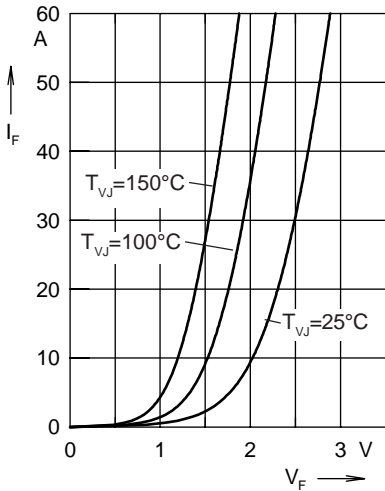


Fig. 17. Forward current  $I_F$  versus  $V_F$

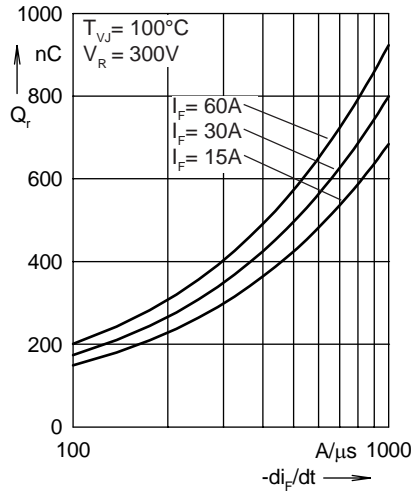


Fig. 18. Reverse recovery charge  $Q_r$  versus  $-di_F/dt$

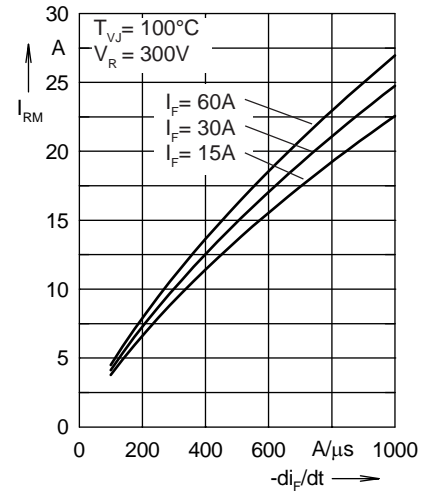


Fig. 19. Peak reverse current  $I_{RM}$  versus  $-di_F/dt$

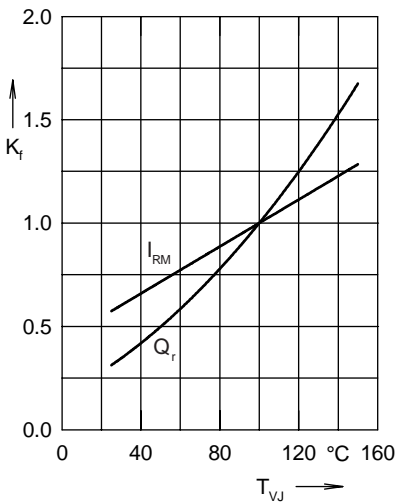


Fig. 20. Dynamic parameters  $Q_r$ ,  $I_{RM}$  versus  $T_{VJ}$

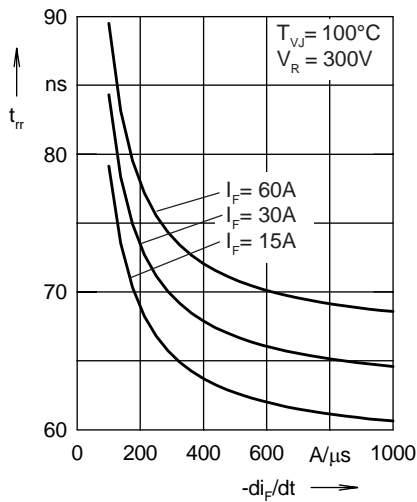


Fig. 21. Recovery time  $t_{rr}$  versus  $-di_F/dt$

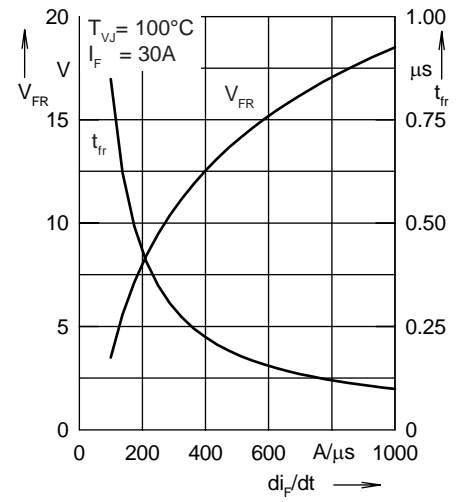


Fig. 22. Peak forward voltage  $V_{FR}$  and  $t_{fr}$  versus  $di_F/dt$

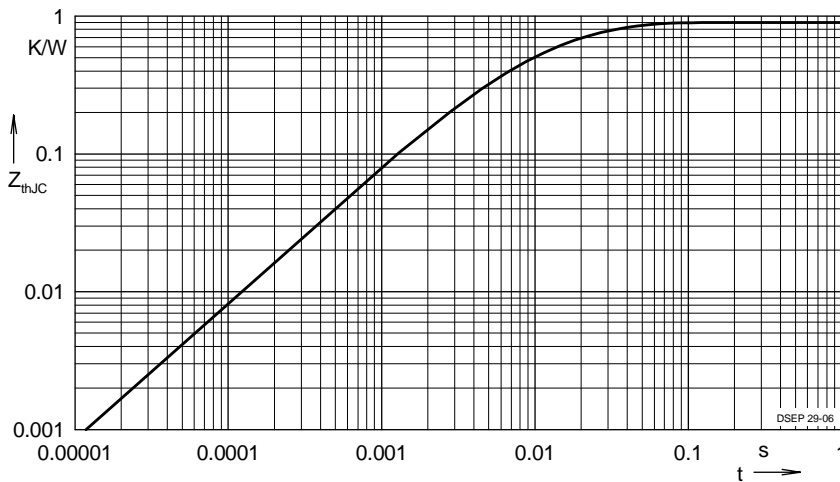


Fig. 23. Transient thermal resistance junction to case

Constants for  $Z_{thJC}$  calculation:

i	$R_{thi}$ (K/W)	$t_i$ (s)
1	0.502	0.0052
2	0.193	0.0003
3	0.205	0.0162

IXYS reserves the right to change limits, test conditions, and dimensions.

IXYS MOSFETs and IGBTs are covered by one or more of the following U.S. patents:

4,835,592 4,881,106 5,017,508 5,049,961 5,187,117 5,486,715 6,306,728B1 6,259,123B1 6,306,728B1  
4,850,072 4,931,844 5,034,796 5,063,307 5,237,481 5,381,025 6,404,065B1 6,162,665 6,534,343