

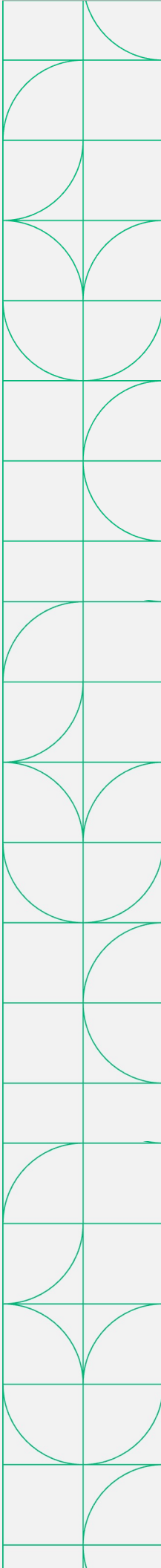

Universal Sensor Input Measurement Bundle with Expansion

Datasheet and Specifications

cDAQ 9174 and NI-9219



Universal Sensor Input Measurement Bundle with Expansion

In-Box Components

Universal Sensor Input Measurement Bundle with Expansion System P/N: 868016-01



cDAQ-9174

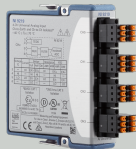

NI-9219



NI-9219

Included Accessories:

- 9972 Backshell
- Desktop Mounting Kit

Recommended Software

FlexLogger

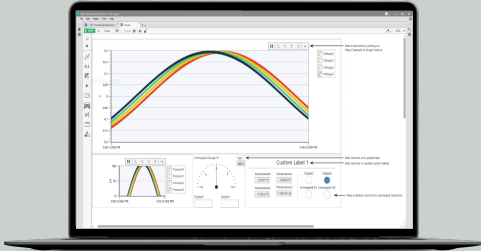

P/N: 785748-3501

No code software that accelerates measurement configuration and logging with NI DAQ Hardware.

- Acquire data and log test results to .tdms or .csv files
- Inline calculations for simple math, filtering, Boolean logic, and more
- Integrated TDMS Viewer for interactive data review

Table of Contents

This document combines the PDFs of this system together. The page numbers in the table of contents correspond to the page number of PDF the component's documentation begins.

cDAQ 9174 Specifications.....	3
NI-9219 Specifications.....	13

SPECIFICATIONS

NI cDAQ™ -9174

NI CompactDAQ Four-Slot USB Chassis

These specifications are for the National Instruments CompactDAQ 9174 chassis only. These specifications are typical at 25 °C unless otherwise noted. For the C Series I/O module specifications, refer to the documentation for the C Series I/O module you are using.

Analog Input

Input FIFO size.....	127 samples per slot
Maximum sample rate ¹	Determined by the C Series I/O module or modules
Timing accuracy ²	50 ppm of sample rate
Timing resolution ³	12.5 ns
Number of channels supported.....	Determined by the C Series I/O module or modules

Analog Output

Number of channels supported	
Hardware-timed task	
Onboard regeneration.....	16
Non-regeneration.....	Determined by the C Series I/O module or modules

¹ Performance dependent on type of installed C Series I/O module and number of channels in the task.

² Does not include group delay. For more information, refer to the documentation for each C Series I/O module.

³ Does not include group delay. For more information, refer to the documentation for each C Series I/O module.

Non-hardware-timed task.....	Determined by the C Series I/O module or modules
Maximum update rate	
Onboard regeneration.....	1.6 MS/s (multi-channel, aggregate)
Non-regeneration.....	Determined by the C Series I/O module or modules
Timing accuracy.....	50 ppm of sample rate
Timing resolution.....	12.5 ns
Output FIFO size	
Onboard regeneration.....	8,191 samples shared among channels used
Non-regeneration.....	127 samples per slot
AO waveform modes.....	Non-periodic waveform, periodic waveform regeneration mode from onboard memory, periodic waveform regeneration from host buffer including dynamic update

Digital Waveform Characteristics

Waveform acquisition (DI) FIFO.....	127 samples per slot
Waveform generation (DO) FIFO.....	2,047 samples
Digital input sample clock frequency	
Streaming to application.....	System-dependent memory
Finite.....	0 to 10 MHz
Digital output sample clock frequency	
Streaming from application.....	System-dependent memory
Regeneration from FIFO.....	0 to 10 MHz
Finite.....	0 to 10 MHz
Timing accuracy.....	50 ppm

General-Purpose Counters/Timers

Number of counters/timers.....	4
Resolution.....	32 bits
Counter measurements.....	Edge counting, pulse, semi-period, period, two-edge separation, pulse width
Position measurements.....	X1, X2, X4 quadrature encoding with Channel Z reloading; two-pulse encoding
Output applications.....	Pulse, pulse train with dynamic updates, frequency division, equivalent time sampling
Internal base clocks.....	80 MHz, 20 MHz, 100 kHz
External base clock frequency.....	0 to 20 MHz
Base clock accuracy.....	50 ppm
Output frequency.....	0 to 20 MHz
Inputs.....	Gate, Source, HW_Arm, Aux, A, B, Z, Up_Down
Routing options for inputs.....	Any module PFI, analog trigger, many internal signals
FIFO.....	Dedicated 127-sample FIFO

Frequency Generator

Number of channels.....	1
Base clocks.....	20 MHz, 10 MHz, 100 kHz
Divisors.....	1 to 16 (integers)
Base clock accuracy.....	50 ppm
Output.....	Any module PFI terminal

Module PFI Characteristics

Functionality.....	Static digital input, static digital output, timing input, and timing output
Timing output sources ⁴	Many analog input, analog output, counter, digital input, and digital output timing signals
Timing input frequency.....	0 to 20 MHz
Timing output frequency.....	0 to 20 MHz

Digital Triggers

Source.....	Any module PFI terminal
Polarity.....	Software-selectable for most signals
Analog input function.....	Start Trigger, Reference Trigger, Pause Trigger, Sample Clock, Sample Clock Timebase
Analog output function.....	Start Trigger, Pause Trigger, Sample Clock, Sample Clock Timebase
Counter/timer function.....	Gate, Source, HW_Arm, Aux, A, B, Z, Up_Down

Module I/O States

At power-on.....	Module-dependent. Refer to the documentation for each C Series I/O module.
------------------	--



Note The chassis may revert the input/output of the modules to their power-on state when the USB cable is removed.

⁴ Actual signals available dependent on type of installed C Series I/O module.

Power Requirements



Caution You must use a National Electric Code (NEC) Class 2 power source with the NI cDAQ-9174 chassis.



Note Some C Series I/O modules have additional power requirements. For more information about C Series I/O module power requirements, refer to the documentation for each C Series I/O module.



Note Sleep mode for C Series I/O modules is not supported in the NI cDAQ-9174.

Input voltage range.....	9 to 30 V
Maximum required input power ⁵	15 W
Power input connector.....	2 positions 3.5 mm pitch pluggable screw terminal with screw locks similar to Sauro CTMH020F8-0N001
Power input mating connector.....	Sauro CTF020V8, Phoenix Contact 1714977, or equivalent
Power consumption from USB,.....	500 μ A maximum 4.10 to 5.25 V

Bus Interface

USB specification.....	USB 2.0 Hi-Speed
High-performance data streams.....	7
Data stream types available.....	Analog input, analog output, digital input, digital output, counter/timer input, counter/timer output, NI-XNET ⁶



Note If you are connecting the NI cDAQ-9174 chassis to a USB hub, the hub must be externally powered.

⁵ Includes maximum 1 W module load per slot across rated temperature and product variations.

⁶ When a session is active, CAN or LIN (NI-XNET) C Series modules use a total of two data streams regardless of the number of NI-XNET modules in the chassis.

Physical Characteristics

Weight (unloaded).....Approx. 574 g (20.2 oz)

Dimensions (unloaded).....159.5 mm × 88.1 mm × 58.9 mm
(6.28 in. × 3.47 in. × 2.3 in.) Refer to the following figure.

If you need to clean the chassis, wipe it with a dry towel.

Figure 1. NI cDAQ-9174 Dimensions

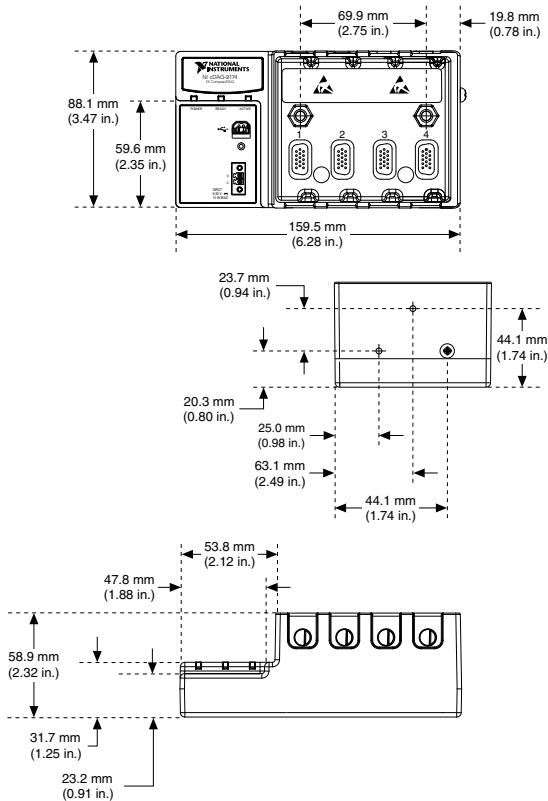

Environmental

Operating temperature ⁷	-20 °C to 55 °C (IEC-60068-2-1 and IEC-60068-2-2)
Storage temperature.....	-40 °C to 85 °C (IEC-600068-2-1 and IEC-60068-2-2)
Ingress protection.....	IP 30
Operating humidity.....	10 to 90% RH, noncondensing (IEC-60068-2-56)
Storage humidity.....	5 to 95% RH, noncondensing (IEC-60068-2-56)
Pollution Degree (IEC 60664).....	2
Maximum altitude.....	5,000 m
Indoor use only.	

Shock and Vibration

To meet these specifications, you must panel mount the NI cDAQ-9174 system, use an NI locking USB cable, and affix ferrules to the ends of the terminal lines.

Operational shock.....	30 g peak, half-sine, 11 ms pulse (Tested in accordance with IEC 60068-2-27. Test profile developed in accordance with MIL-PRF-28800F.)
Random vibration	
Operating.....	5 to 500 Hz, 0.3 g _{rms}
Non-operating.....	5 to 500 Hz, 2.4 g _{rms} (Tested in accordance with IEC 60068-2-64. Non-operating test profile exceeds the requirements of MIL PRF-28800F, Class 3.)

⁷ When operating the NI cDAQ-9174 in temperatures below 0 °C, you must use the PS-15 power supply or another power supply rated for below 0 °C.

Safety

This product meets the requirements of the following standards of safety for electrical equipment for measurement, control, and laboratory use:

- IEC 61010-1, EN 61010-1
- UL 61010-1, CSA 61010-1



Note For UL and other safety certifications, refer to the product label or the *Online Product Certification* section.

Electromagnetic Compatibility

This product meets the requirements of the following EMC standards for electrical equipment for measurement, control, and laboratory use:

- EN 61326-1 (IEC 61326-1): Class A emissions; Basic immunity
- EN 55011 (CISPR 11): Group 1, Class A emissions
- AS/NZS CISPR 11: Group 1, Class A emissions
- FCC 47 CFR Part 15B: Class A emissions
- ICES-001: Class A emissions



Note In the United States (per FCC 47 CFR), Class A equipment is intended for use in commercial, light-industrial, and heavy-industrial locations. In Europe, Canada, Australia, and New Zealand (per CISPR 11) Class A equipment is intended for use only in heavy-industrial locations.



Note Group 1 equipment (per CISPR 11) is any industrial, scientific, or medical equipment that does not intentionally generate radio frequency energy for the treatment of material or inspection/analysis purposes.



Note For EMC declarations and certifications, refer to the *Online Product Certification* section.

CE Compliance

This product meets the essential requirements of applicable European Directives as follows:

- 2006/95/EC; Low-Voltage Directive (safety)
- 2004/108/EC; Electromagnetic Compatibility Directive (EMC)

Online Product Certification

To obtain product certifications and the DoC for this product, visit ni.com/certification, search by model number or product line, and click the appropriate link in the Certification column.

Environmental Management

NI is committed to designing and manufacturing products in an environmentally responsible manner. NI recognizes that eliminating certain hazardous substances from our products is beneficial not only to the environment but also to NI customers.

For additional environmental information, refer to the *Minimize Our Environmental Impact* web page at ni.com/environment. This page contains the environmental regulations and directives with which NI complies, as well as other environmental information not included in this document.

Waste Electrical and Electronic Equipment (WEEE)



EU Customers At the end of the product life cycle, all products must be sent to a WEEE recycling center. For more information about WEEE recycling centers, National Instruments WEEE initiatives, and compliance with WEEE Directive 2002/96/EC on Waste Electrical and Electronic Equipment, visit ni.com/environment/weee.

电子信息产品污染控制管理办法（中国 RoHS）



中国客户 National Instruments 符合中国电子信息产品中限制使用某些有害物质指令 (RoHS)。关于 National Instruments 中国 RoHS 合规性信息，请登录 ni.com/environment/rohs_china。(For information about China RoHS compliance, go to ni.com/environment/rohs_china.)

Refer to the *NI Trademarks and Logo Guidelines* at ni.com/trademarks for information on National Instruments trademarks. Other product and company names mentioned herein are trademarks or trade names of their respective companies. For patents covering National Instruments products/technology, refer to the appropriate location: **Help»Patents** in your software, the `patents.txt` file on your media, or the *National Instruments Patent Notice* at ni.com/patents. You can find information about end-user license agreements (EULAs) and third-party legal notices in the readme file for your NI product. Refer to the *Export Compliance Information* at ni.com/legal/export-compliance for the National Instruments global trade compliance policy and how to obtain relevant HTS codes, ECCNs, and other import/export data.

© 2013 National Instruments. All rights reserved.

374045A-01 May13

DATASHEET

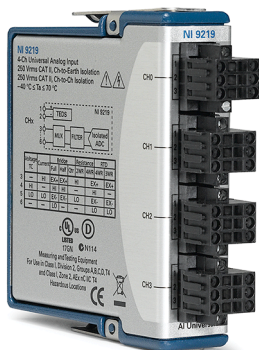

NI 9219

4 AI, 100 S/s/ch Simultaneous, Universal Measurements



- Spring-terminal connectivity
- Support for Thermocouple (50 S/s/ch), RTD, Resistance, Full-Bridge, Half-Bridge, Quarter-Bridge, Voltage, and Current Measurements
- Voltage and current excitation
- 250 VAC, CAT II, channel-to-channel isolation

The NI 9219 is a universal C Series module designed for multipurpose testing in any NI CompactDAQ or CompactRIO chassis. With the NI 9219, you can measure several signals from sensors such as strain gages, RTDs, thermocouples, load cells, and other powered sensors. The channels are individually selectable, so you can perform a different measurement type on each of the four channels. Measurement ranges differ for each type of measurement and include up to ± 60 V for voltage and ± 25 mA for current.

	Kit Contents	<ul style="list-style-type: none">• NI 9219• NI 9219 Getting Started Guide• Spring-Terminal Tool
	Accessories	<ul style="list-style-type: none">• NI 9972 Backshell Connector Kit

NI C Series Overview



NI provides more than 100 C Series modules for measurement, control, and communication applications. C Series modules can connect to any sensor or bus and allow for high-accuracy measurements that meet the demands of advanced data acquisition and control applications.

- Measurement-specific signal conditioning that connects to an array of sensors and signals
- Isolation options such as bank-to-bank, channel-to-channel, and channel-to-earth ground
- -40 °C to 70 °C temperature range to meet a variety of application and environmental needs
- Hot-swappable

The majority of C Series modules are supported in both CompactRIO and CompactDAQ platforms and you can move modules from one platform to the other with no modification.

CompactRIO



CompactRIO combines an open-embedded architecture with small size, extreme ruggedness, and C Series modules in a platform powered by the NI LabVIEW reconfigurable I/O (RIO) architecture. Each system contains an FPGA for custom timing, triggering, and processing with a wide array of available modular I/O to meet any embedded application requirement.

CompactDAQ

CompactDAQ is a portable, rugged data acquisition platform that integrates connectivity, data acquisition, and signal conditioning into modular I/O for directly interfacing to any sensor or signal. Using CompactDAQ with LabVIEW, you can easily customize how you acquire, analyze, visualize, and manage your measurement data.



Software

LabVIEW Professional Development System for Windows



- Use advanced software tools for large project development
- Generate code automatically using DAQ Assistant and Instrument I/O Assistant
- Use advanced measurement analysis and digital signal processing
- Take advantage of open connectivity with DLLs, ActiveX, and .NET objects
- Build DLLs, executables, and MSI installers

NI LabVIEW FPGA Module



- Design FPGA applications for NI RIO hardware
- Program with the same graphical environment used for desktop and real-time applications
- Execute control algorithms with loop rates up to 300 MHz
- Implement custom timing and triggering logic, digital protocols, and DSP algorithms
- Incorporate existing HDL code and third-party IP including Xilinx IP generator functions
- Purchase as part of the LabVIEW Embedded Control and Monitoring Suite

NI LabVIEW Real-Time Module

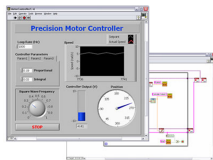

- Design deterministic real-time applications with LabVIEW graphical programming
- Download to dedicated NI or third-party hardware for reliable execution and a wide selection of I/O
- Take advantage of built-in PID control, signal processing, and analysis functions
- Automatically take advantage of multicore CPUs or set processor affinity manually
- Take advantage of real-time OS, development and debugging support, and board support
- Purchase individually or as part of a LabVIEW suite

NI 9219 Circuitry

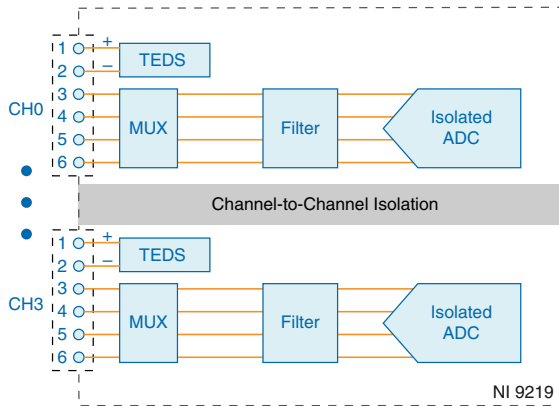

- The NI 9219 is channel-to-channel isolated.
- Four 24-bit analog-to-digital converters (ADCs) simultaneously sample all four analog input channels.
- The NI 9219 enables an excitation circuit for all input modes that require excitation.
- The NI 9219 reconfigures the signal conditioning for each measurement type.

Voltage Circuitry

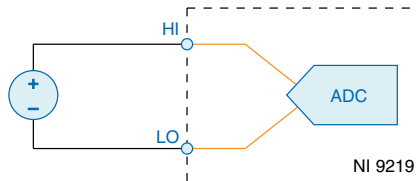

- The ADC measures voltage across the HI and LO terminals.
- The NI 9219 has ± 60 V, ± 15 V, ± 4 V, ± 1 V, and ± 125 mV voltage ranges.

Current Circuitry

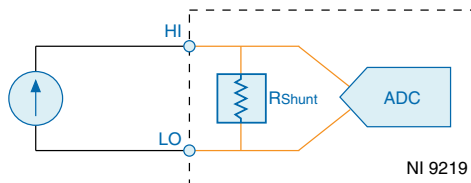

The NI 9219 computes current from the voltage that the ADC measures across an internal shunt resistor.

Thermocouple Circuitry

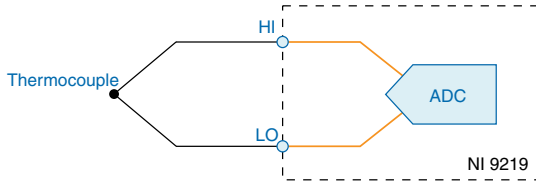

- The NI 9219 uses the ± 125 mV range of the ADC to return a voltage reading.
- Each channel has a built-in thermistor for cold-junction compensation (CJC) calculations.

4-Wire Resistance and 4-Wire RTD Circuitry

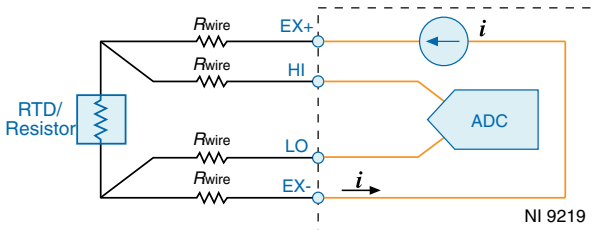

- The NI 9219 sources a current, which varies based on the resistance of the load, between the EX+ and EX- terminals. The NI 9219 computes measured resistance from the resulting voltage reading.
- Lead wire resistance does not affect these measurement types because a negligible amount of current flows across the HI and LO terminals due to the high input impedance of the ADC.

3-Wire RTD Circuitry

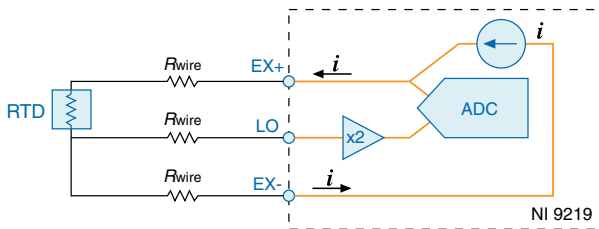

- The NI 9219 sources a current, which varies based on the resistance of the load, between the EX+ and EX- terminals.
- The NI 9219 compensates for lead wire resistance in hardware if all the lead wires have the same resistance.
- The NI 9219 applies a gain of 2x to the voltage across the negative lead wire and the ADC uses this voltage as the negative reference to cancel the resistance error across the positive lead wire.

2-Wire Resistance and Quarter-Bridge Circuitry

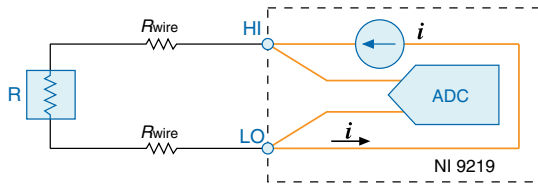

- The NI 9219 sources a current, which varies based on the resistance of the load, between the HI and LO terminals.
- The NI 9219 computes measured resistance from the resulting voltage reading.
- 2-Wire Resistance and Quarter-Bridge measurement types do not compensate for lead wire resistance.

Full-Bridge Circuitry

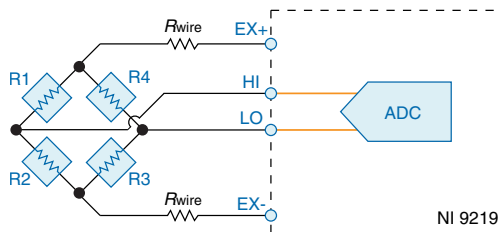

- The ADC reads the HI and LO inputs differentially.
- The internal voltage excitation sets the input range of the ADC and returns voltage readings that are proportional to the excitation level. The internal excitation voltage varies based on the resistance of the sensor.

Half-Bridge Circuitry

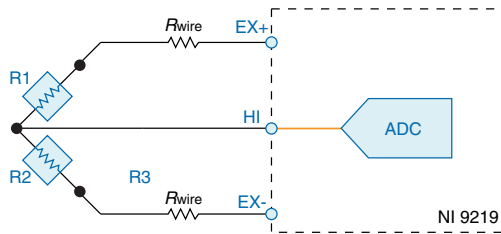

- The HI input is referenced to EX-.
- The internal voltage excitation sets the input range of the ADC and returns voltage readings that are proportional to the excitation level. The internal excitation voltage varies based on the resistance of the sensor.

Digital In Circuitry

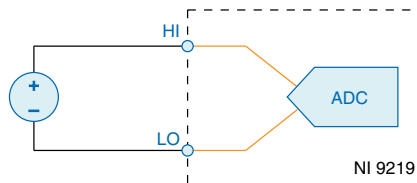

- The NI 9219 has a 60 V unipolar threshold that you can set in software.
- The digital in measurement type is only supported in CompactRIO systems.

Open Contact Circuitry

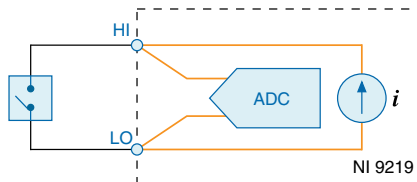

- The NI 9219 sources a current between the HI and LO terminals and determines if the two terminals are open or closed based on the measured current through the terminals.
- When the circuit is open, make sure no more than ± 60 V is sourced across the switch.
- The open contact measurement type is only supported in CompactRIO systems.

Timing Modes

The NI 9219 supports high-resolution, best 50 Hz rejection, best 60 Hz rejection, and high-speed timing modes. High-resolution timing mode optimizes maximum overall noise rejection and provides rejection of 50 Hz and 60 Hz noise. Best 50 Hz rejection optimizes 50 Hz noise rejection. Best 60 Hz rejection optimizes 60 Hz noise rejection. High-speed timing mode optimizes sample rate.

NI 9219 Specifications

The following specifications are typical for the range -40 °C to 70 °C unless otherwise noted.



Caution Do not operate the NI 9219 in a manner not specified in this document. Product misuse can result in a hazard. You can compromise the safety protection built into the product if the product is damaged in any way. If the product is damaged, return it to NI for repair.

Input Characteristics

Number of channels	4 analog input channels
ADC resolution	24 bits
Type of ADC	Delta-sigma (with analog prefiltering)
Sampling mode	Simultaneous
Type of TEDS supported	IEEE 1451.4 TEDS Class 2 (Interface)

Table 1. Input Ranges

Measurement Type	Nominal Range(s)	Actual Range(s)
Voltage	$\pm 60\text{ V}$, $\pm 15\text{ V}$, $\pm 4\text{ V}$, $\pm 1\text{ V}$, $\pm 125\text{ mV}$	$\pm 60\text{ V}$, $\pm 15\text{ V}$, $\pm 4\text{ V}$, $\pm 1\text{ V}$, $\pm 125\text{ mV}$
Current	$\pm 25\text{ mA}$	$\pm 25\text{ mA}$
Thermocouple	$\pm 125\text{ mV}$	$\pm 125\text{ mV}$
4-Wire and 2-Wire Resistance	10 k Ω , 1 k Ω	10.5 k Ω , 1.05 k Ω
4-Wire and 3-Wire RTD	Pt 1000, Pt 100	5.05 k Ω , 505 Ω
Quarter-Bridge	350 Ω , 120 Ω	390 Ω , 150 Ω
Half-Bridge	$\pm 500\text{ mV/V}$	$\pm 500\text{ mV/V}$
Full-Bridge	$\pm 62.5\text{ mV/V}$, $\pm 7.8\text{ mV/V}$	$\pm 62.5\text{ mV/V}$, $\pm 7.8125\text{ mV/V}$

Table 1. Input Ranges (Continued)

Measurement Type	Nominal Range(s)	Actual Range(s)
Digital In	—	0 V to 60 V
Open Contact	—	1.05 k Ω

Conversion time, all channels

No channels configured as a thermocouple

High speed	10 ms
Best 60 Hz rejection	110 ms
Best 50 Hz rejection	130 ms
High resolution	500 ms

One or more channels configured as a thermocouple

High speed	20 ms
Best 60 Hz rejection	120 ms
Best 50 Hz rejection	140 ms
High resolution	510 ms

Overvoltage protection

Terminals 1 and 2	± 30 V
Terminals 3 through 6, across any combination	± 60 V

Input impedance

Voltage and Digital In (± 60 V, ± 15 V, ± 4 V)	1 M Ω
Current	< 40 Ω
All other measurement types	>1 G Ω

Table 2. Accuracy

Measurement Type	Range	Gain Error (Percent of Reading)	Offset Error (ppm of Range)
		Typical (25 °C ±5 °C), Maximum (-40 °C to 70 °C)	
Voltage	±60 V	±0.3, ±0.4	±20, ±50
	±15 V	±0.3, ±0.4	±60, ±180
	±4 V	±0.3, ±0.4	±240, ±720
	±1 V	±0.1, ±0.18	±15, ±45
Voltage/Thermocouple	±125 mV	±0.1, ±0.18	±120, ±360
Current	±25 mA	±0.1, ±0.6	±30, ±100
4-Wire and 2-Wire ¹ Resistance	10 kΩ	±0.1, ±0.5	±120, ±320
	1 kΩ	±0.1, ±0.5	±1200, ±3200
4-Wire and 3-Wire RTD	Pt 1000	±0.1, ±0.5	±240, ±640
	Pt 100	±0.1, ±0.5	±2400, ±6400
Quarter-Bridge	350 Ω	±0.1, ±0.5	±2400, ±6400
	120 Ω	±0.1, ±0.5	±2400, ±6400
Half-Bridge	±500 mV/V	±0.03, ±0.07	±300, ±450
Full-Bridge	±62.5 mV/V	±0.03, ±0.08	±300, ±1000
	±7.8 mV/V	±0.03, ±0.08	±2200, ±8000

Cold-junction compensation sensor accuracy ±1 °C typical

¹ 2-wire resistance accuracy assumes 0 Ω of lead wire resistance. 2-wire resistance accuracy depends on the lead wire resistance.

Table 3. Stability

Measurement Type	Range	Gain Drift (ppm of Reading/°C)	Offset Drift (ppm of Range/°C)
Voltage	±60 V	±20	±0.2
	±15 V	±20	±0.8
	±4 V	±20	±3.2
	±1 V	±10	±0.2
Voltage/Thermocouple	±125 mV	±10	±1.6
Current	±25 mA	±15	±0.4
4-Wire and 2-Wire Resistance	10 kΩ	±15	±3
	1 kΩ	±15	±30
4-Wire and 3-Wire RTD	Pt 1000	±15	±6
	Pt 100	±15	±60
Quarter-Bridge	350 Ω	±15	±120
	120 Ω	±15	±240
Half-Bridge	±500 mV/V	±3	±20
Full-Bridge	±62.5 mV/V	±3	±20
	±7.8 mV/V	±3	±20

Table 4. Input Noise in ppm of Range_{rms}

Measurement Type	Range	Timing Mode			
		High Speed	Best 60 Hz Rejection	Best 50 Hz Rejection	High Resolution
Voltage	±60 V	7.6	1.3	1.3	0.5
	±15 V	10.8	1.9	1.9	0.7
	±4 V	10.8	2.7	2.7	1.3
	±1 V	7.6	1.3	1.3	0.5
Voltage/Thermocouple	±125 mV	10.8	1.9	1.9	1.0

Table 4. Input Noise in ppm of Range_{rms} (Continued)

Measurement Type	Range	Timing Mode			
		High Speed	Best 60 Hz Rejection	Best 50 Hz Rejection	High Resolution
Current	±25 mA	10.8	1.9	1.9	1.0
4-Wire and 2-Wire Resistance	10 kΩ	4.1	1.3	0.8	0.3
	1 kΩ	7.1	1.8	1.2	0.7
4-Wire and 3-Wire RTD	Pt 1000	7.6	1.7	1.1	0.4
	Pt 100	10.8	1.9	1.9	0.9
Quarter-Bridge	350 Ω	5.4	1.0	1.0	0.7
	120 Ω	5.4	1.0	1.0	0.7
Half-Bridge	±500 mV/V	3.8	0.5	0.5	0.2
Full-Bridge	±62.5 mV/V	5.4	1.0	1.0	0.8
	±7.8 mV/V	30	4.7	4.7	2.3

Input bias current <1 nA

INL ±15 ppm

CMRR ($f_{in} = 60$ Hz) >100 dB

NMRR

Best 60 Hz rejection 90 dB at 60 Hz

Best 50 Hz rejection 80 dB at 50 Hz

High resolution 65 dB at 50 Hz and 60 Hz

Table 5. Half-Bridge, Full-Bridge, Quarter-Bridge, Resistance, and RTD Excitation Level

Measurement Type	Load Resistance (Ω)	Characteristic Excitation Level ²
Half-Bridge	700	2.5 V
	240	2.0 V

² Excitation level is a characteristic and is not software-selectable.

Table 5. Half-Bridge, Full-Bridge, Quarter-Bridge, Resistance, and RTD Excitation Level
(Continued)

Measurement Type	Load Resistance (Ω)	Characteristic Excitation Level ²
Full-Bridge	350	2.7 V
	120	2.2 V
Resistance, RTD, and Quarter-Bridge	120	50 mV
	350	150 mV
	1,000	430 mV
	10,000	2200 mV

MTBF

384,716 hours at 25 °C; Bellcore Issue 2,
Method 1, Case 3, Limited Part Stress Method

Power Requirements

Power consumption from chassis

Active mode	750 mW maximum
Sleep mode	25 μ W maximum

Thermal dissipation (at 70 °C)

Active mode	625 mW maximum
Sleep mode	25 μ W maximum

Physical Characteristics

If you need to clean the module, wipe it with a dry towel.



Tip For two-dimensional drawings and three-dimensional models of the C Series module and connectors, visit ni.com/dimensions and search by module number.

Spring-terminal wiring

Gauge	0.08 mm ² to 1.0 mm ² (28 AWG to 18 AWG) copper conductor wire
Wire strip length	7 mm (0.28 in.) of insulation stripped from the end

² Excitation level is a characteristic and is not software-selectable.

Temperature rating	90 °C minimum
Wires per spring terminal	One wire per spring terminal
Connector securement	
Securement type	Screw flanges provided
Torque for screw flanges	0.2 N · m (1.80 lb · in.)
Weight	156 g (5.5 oz)

Safety Voltages

Connect only voltages that are within the following limits.

Channel-to-channel	
Continuous	250 VAC, Measurement Category II
Withstand	1,390 VAC, verified by a 5 s dielectric withstand test
Channel-to-earth ground	
Continuous	250 VAC, Measurement Category II
Withstand	2,300 VAC, verified by a 5 s dielectric withstand test
Zone 2 hazardous locations applications in Europe	
Channel-to-channel and channel-to-earth ground	60 VDC, Measurement Category I

Measurement Category I is for measurements performed on circuits not directly connected to the electrical distribution system referred to as *MAINS* voltage. *MAINS* is a hazardous live electrical supply system that powers equipment. This category is for measurements of voltages from specially protected secondary circuits. Such voltage measurements include signal levels, special equipment, limited-energy parts of equipment, circuits powered by regulated low-voltage sources, and electronics.



Caution If using in Division 2 or Zone 2 hazardous locations applications, do not connect the NI 9219 to signals or use for measurements within Measurement Categories II, III, or IV.



Note Measurement Categories CAT I and CAT O are equivalent. These test and measurement circuits are not intended for direct connection to the *MAINS* building installations of Measurement Categories CAT II, CAT III, or CAT IV.

Measurement Category II is for measurements performed on circuits directly connected to the electrical distribution system. This category refers to local-level electrical distribution, such as that provided by a standard wall outlet, for example, 115 V for U.S. or 230 V for Europe.



Caution Do not connect the NI 9219 to signals or use for measurements within Measurement Categories III or IV.

Hazardous Locations

U.S. (UL)	Class I, Division 2, Groups A, B, C, D, T4; Class I, Zone 2, AEx nA IIC T4
Canada (C-UL)	Class I, Division 2, Groups A, B, C, D, T4; Class I, Zone 2, Ex nA IIC T4
Europe (ATEX) and International (IECEX)	Ex nA IIC T4 Gc

Safety and Hazardous Locations Standards

This product is designed to meet the requirements of the following electrical equipment safety standards for measurement, control, and laboratory use:

- IEC 61010-1, EN 61010-1
- UL 61010-1, CSA 61010-1
- EN 60079-0:2012, EN 60079-15:2010
- IEC 60079-0: Ed 6, IEC 60079-15; Ed 4
- UL 60079-0; Ed 5, UL 60079-15; Ed 3
- CSA 60079-0:2011, CSA 60079-15:2012



Note For UL and other safety certifications, refer to the product label or the [Online Product Certification](#) section.

Electromagnetic Compatibility

This product meets the requirements of the following EMC standards for sensitive electrical equipment for measurement, control, and laboratory use:

- EN 61326 (IEC 61326): Class A emissions; Industrial immunity
- EN 55011 (CISPR 11): Group 1, Class A emissions
- AS/NZS CISPR 11: Group 1, Class A emissions
- FCC 47 CFR Part 15B: Class A emissions
- ICES-001: Class A emissions



Note For the standards applied to assess the EMC of this product, refer to the [Online Product Certification](#) section.

CE Compliance

This product meets the essential requirements of applicable European Directives, as follows:

- 2014/35/EU; Low-Voltage Directive (safety)
- 2014/30/EU; Electromagnetic Compatibility Directive (EMC)
- 94/9/EC; Potentially Explosive Atmospheres (ATEX)

Online Product Certification

Refer to the product Declaration of Conformity (DoC) for additional regulatory compliance information. To obtain product certifications and the DoC for this product, visit ni.com/certification, search by model number or product line, and click the appropriate link in the Certification column.

Shock and Vibration

To meet these specifications, you must panel mount the system.

Operating vibration

Random (IEC 60068-2-64)	5 g _{rms} , 10 Hz to 500 Hz
Sinusoidal (IEC 60068-2-6)	5 g, 10 Hz to 500 Hz
Operating shock (IEC 60068-2-27)	30 g, 11 ms half sine; 50 g, 3 ms half sine; 18 shocks at 6 orientations

Environmental

Refer to the manual for the chassis you are using for more information about meeting these specifications.

Operating temperature (IEC 60068-2-1, IEC 60068-2-2)	-40 °C to 70 °C
Storage temperature (IEC 60068-2-1, IEC 60068-2-2)	-40 °C to 85 °C
Ingress protection	IP40
Operating humidity (IEC 60068-2-78)	10% RH to 90% RH, noncondensing
Storage humidity (IEC 60068-2-78)	5% RH to 95% RH, noncondensing
Pollution Degree	2
Maximum altitude	2,000 m

Indoor use only.

Environmental Management

NI is committed to designing and manufacturing products in an environmentally responsible manner. NI recognizes that eliminating certain hazardous substances from our products is beneficial to the environment and to NI customers.

For additional environmental information, refer to the *Minimize Our Environmental Impact* web page at ni.com/environment. This page contains the environmental regulations and directives with which NI complies, as well as other environmental information not included in this document.

Waste Electrical and Electronic Equipment (WEEE)



EU Customers At the end of the product life cycle, all NI products must be disposed of according to local laws and regulations. For more information about how to recycle NI products in your region, visit ni.com/environment/weee.

电子信息产品污染控制管理办法（中国 RoHS）



中国客户 National Instruments 符合中国电子信息产品中限制使用某些有害物质指令 (RoHS)。关于 National Instruments 中国 RoHS 合规性信息，请登录 ni.com/environment/rohs_china。(For information about China RoHS compliance, go to ni.com/environment/rohs_china.)

Calibration

You can obtain the calibration certificate and information about calibration services for the NI 9219 at ni.com/calibration.

Calibration interval

1 year

Refer to the *NI Trademarks and Logo Guidelines* at ni.com/trademarks for information on NI trademarks. Other product and company names mentioned herein are trademarks or trade names of their respective companies. For patents covering NI products/technology, refer to the appropriate location: **Help»Patents** in your software, the `patents.txt` file on your media, or the *National Instruments Patent Notice* at ni.com/patents. You can find information about end-user license agreements (EULAs) and third-party legal notices in the readme file for your NI product. Refer to the *Export Compliance Information* at ni.com/legal/export-compliance for the NI global trade compliance policy and how to obtain relevant HTS codes, ECCNs, and other import/export data. NI MAKES NO EXPRESS OR IMPLIED WARRANTIES AS TO THE ACCURACY OF THE INFORMATION CONTAINED HEREIN AND SHALL NOT BE LIABLE FOR ANY ERRORS. U.S. Government Customers: The data contained in this manual was developed at private expense and is subject to the applicable limited rights and restricted data rights as set forth in FAR 52.227-14, DFAR 252.227-7014, and DFAR 252.227-7015.

© 2016 National Instruments. All rights reserved.

374473A-02 Apr16