

6

### The MCT-4A Series

Dual & Single In Line Package (SIL & DIL)

High Level Analog Output

3.3 & 5.0 Vdc Supply Voltages

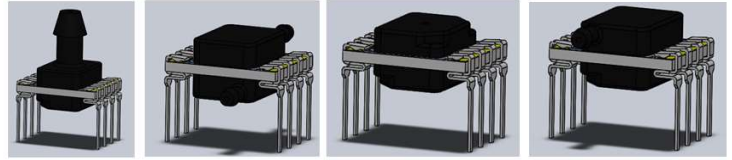

#### DESCRIPTION

Advanced Sensors Multi Chip Technology (MCT) 4A Series incorporates the latest mixed signal ASIC (Application Specific Integrated Circuit) with a bonded silicon gage to provide a high level analog output for medical, life science and pneumatic control industries. The designs superior performance provides 1% Total Error across a wide temperature range of -10 to 85 °C. The ASIC's advanced design allows for the sensor output to be limited for safety critical operations with internal error checking of the sensor's input and output lines. With all the advanced features, the MCT-4A series is the ideal choice for OEM customers.

#### APPLICATIONS

- Pneumatic controls
- Automotive diagnostics
- Medical equipment/instrumentation
- Air Speed and Altitude
- Environmental controls
- Barometric pressure measurement
- Factory Automation
- Process Controls

#### FEATURES

- Ratiometric, Analog Voltage Output
- Low Power Option
- 3.3 & 5.0Vdc Supply Voltages
- Low Overall Errors, 1%TEB
- Many Port Configurations
- Custom Outputs and Ranges Available

#### SPECIFICATIONS

	Symbol	Min	Typical	Max	Unit	Note
<b>Performance Specifications</b>						
Supply Voltage		2.7V	3.3	5.50	V	
Current Consumption				3	mA	
Current Consumption, -L Option			0.25		mA	
Pressure Accuracy		-0.25		0.25	mA	2
Total Error Band, 5inH20 and above	TEB	-1.00		1.00	%FSS	3
Total Error Band, Below 5inH20 to 10mBar	TEB	-1.50		1.50	%FSS	3
Total Error Band, Below 10mBar to 6mBar	TEB	-2.00		2.00	%FSS	3
Total Error Band, Below 6mBar to 1.25mBar	TEB	-3.00		3.00	%FSS	3
Output DAC Resolution				12	bits	
Output (Type 1) at Pmin			10		%Vdd	
Output (Type 1) at Pmax			90		%Vdd	
Output (Type 2) at Pmin			5		%Vdd	
Output (Type 2) at Pmax			95		%Vdd	
Conversion Time			1.0		mS	4
Power On to Valid Data				<10	mS	5
Weight				3	grams	
Compensated Temperature			-10 to 85		°C	6
Operating Temperature			-40 to 125		°C	6

SPECIFICATIONS	Symbol	Min	Typical	Max	Unit	Note
<b>Absolute Maximum Conditions</b>						<b>10</b>
Supply Voltage		-5.0		6	V	
Storage Temperature		-40		125	°C	6
Package Integrity, Common Mode				300	psi	7
Proof Pressure				3x		8
Burst Pressure				5x		9
Media Compatibility		CDA, Non Ionic, Non Corrosive Gases				
Wetted Materials		Ceramic, RTV, Epoxy, Silicon, Gold, Aluminum, LCP				

**Reference Conditions:** Vsupply: 3.30Vdc or 5.00, Ta=25 °C, Positive Pressure Port A

1. All specification at reference conditions unless otherwise noted.
2. Maximum deviation from a Best Fit Straight Line through Pmin and Pmax measured at 25 °C. Errors included Pressure Non Linearity, Pressure Hysteresis and Repeatability.
3. Maximum deviation from the Ideal Transfer Function expressed as a percentage of the %FSS over the compensated temperature range. Includes calibration errors (Offset & Span), temperature errors (Offset & Span), pressure non-linearity, pressure and thermal hysteresis.
4. The time for the output DAC to be updated with new data.
5. The time for the output DAC to have valid data after a power on reset.
6. Compensated, operating and storage temperatures for mBar/inH2O ranges are 0 °C to 60 °C, -10 °C to 85 °C, and -20 °C to 105 °C respectively
7. Maximum pressure the sensor package can withstand without rupture.
8. Maximum pressure without degrading sensor's performance specifications.
9. Maximum pressure the silicon diaphragm can withstand without rupture.
10. Exceeding Absolute Maximum Specification may damage the device. Extended exposure beyond the operating conditions may affect device reliability.
11. Enabled Diagnostic option will clip the output voltage at 5% and 95% of supply voltage. Output will remain within 2.5% of the supply rails when the diagnostic is triggered.
12. Switch Port option will change the Positive Pressure Port to B on dual pressure port configurations (VHD, HBD)

### PRESSURE TRANSFER FUNCTIONS

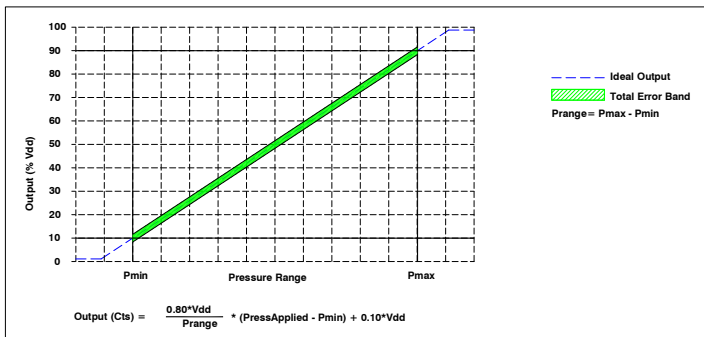

Type 1, 10-90%, Pressure Transfer Function

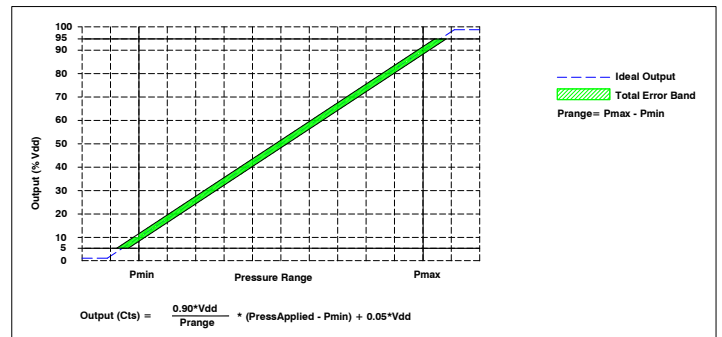

Type 2, 5-95%, Pressure Transfer Function

**MECHANICAL DIMENSIONS in [mm]**

**DUAL IN LINE, THRU HOLE**

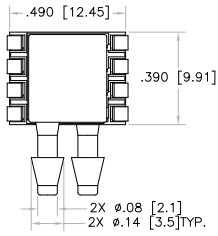

**HORIZONTAL BARB, DUAL**

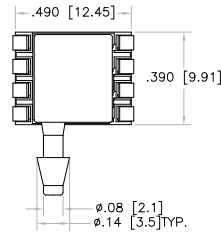

**HORIZONTAL BARB, TOP**

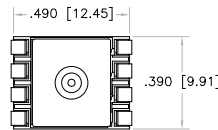
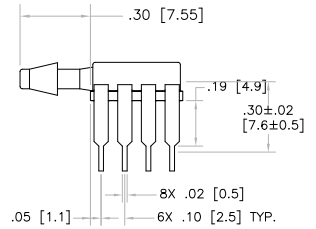
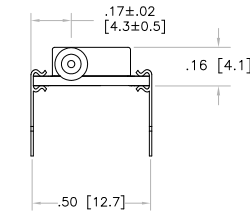
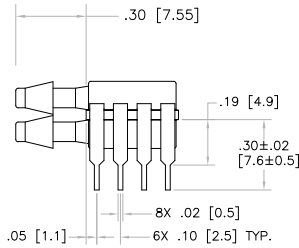
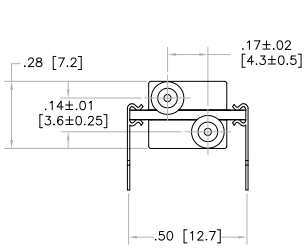

**VERTICAL BARB, TOP**

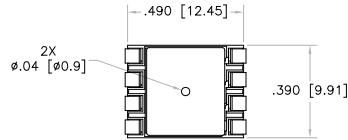

**VERTICAL HOLE, DUAL**

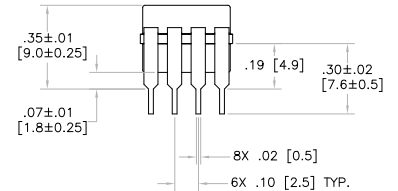
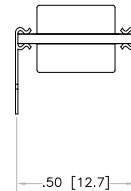
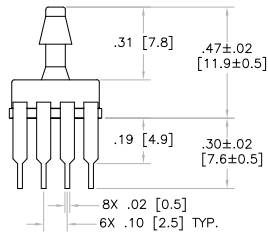
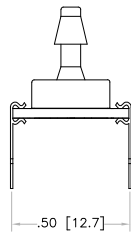

# DUAL IN LINE, J LEAD SMT

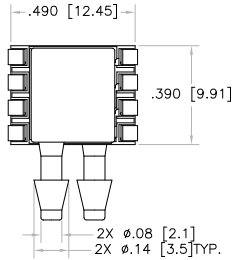

**HORIZONTAL BARB, DUAL**

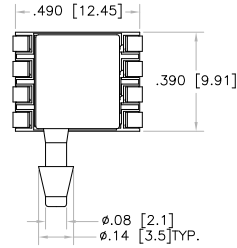

**HORIZONTAL BARB, TOP**

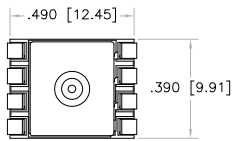
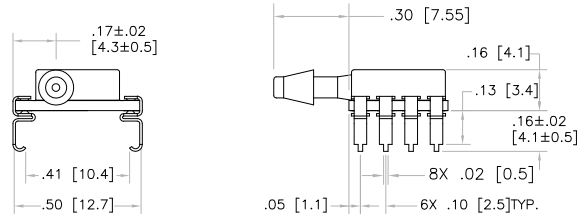
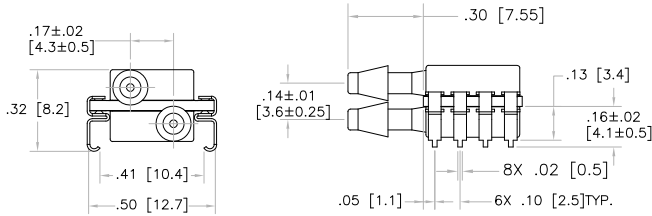

**VERTICAL BARB, TOP**

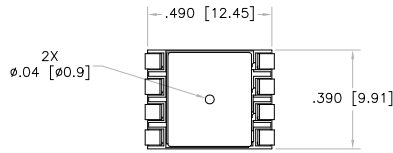

**VERTICAL HOLE, DUAL**

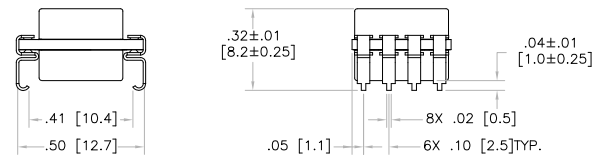
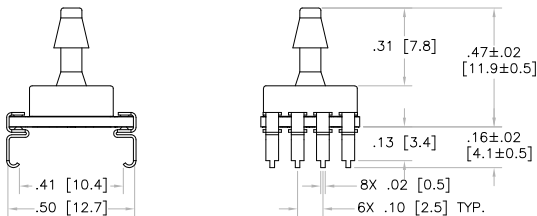

# SINGLE IN LINE, S & SL LEAD

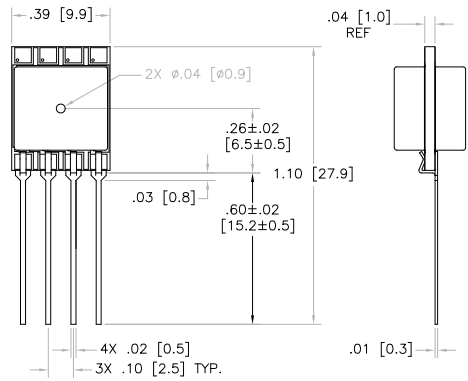
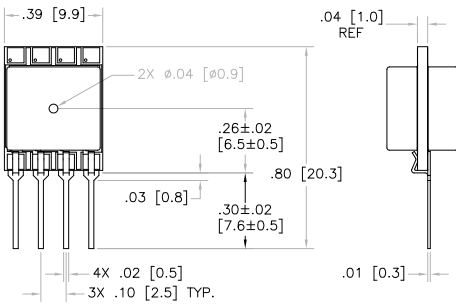
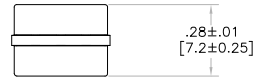
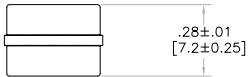

VERTICAL HOLE, DUAL  
S PIN STYLE

VERTICAL HOLE, DUAL  
SL PIN STYLE

### PORT DESIGNATION

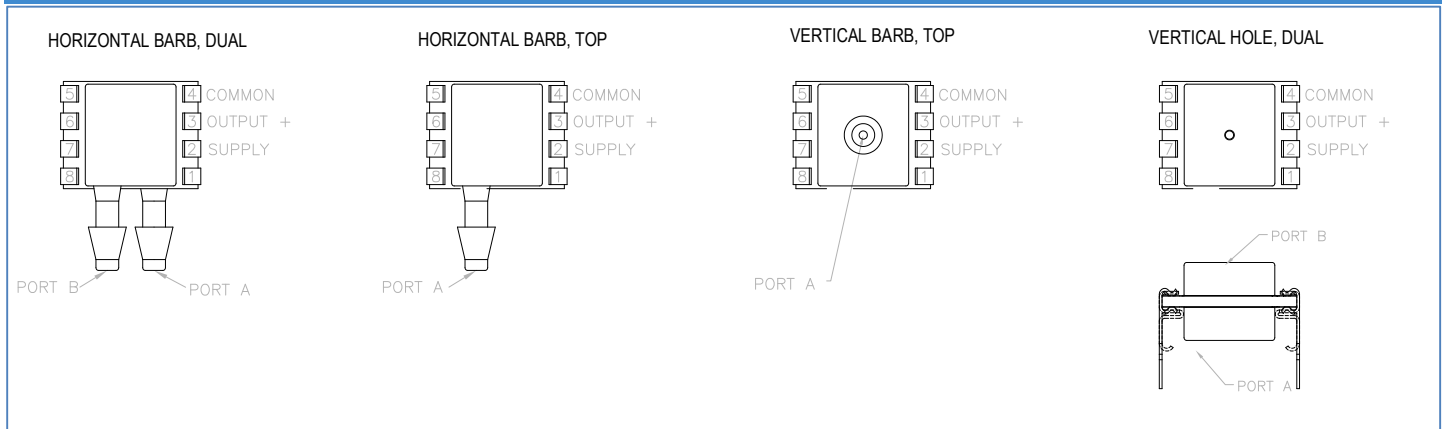

### PART NUMBERING FOR ORDERS

Series	Port Type	Package	Pressure Range	Pressure Units	Pressure Type (Range Availability) [Package Availability]	Calibrated Voltage	Output Type	Options
MCT-4A	VHD=Vertical Hole, Dual	J= J lead SMT	005	M=mBar	G= Gage (All Ranges) [All Port Types]	3=3.3Vdc	Type1= 10 -90% of Supply Voltage	-L Low Power -G Gel Coat -PG Potted Gel; -DE Diagnostics Enabled (See Note 11) -SP Switched Port (See Note 12)
			010					
	HBD=Horizontal Barb, Dual	T= DIL Thru Hole	020	P=PSI	A=Absolute (15 PSI Range & above, 1 Bar Ranges & above) [All Port Types]	5-5.0Vdc	Type2= 5 -95% of Supply Voltage	
			050					
			100					
	VBT=Vertical Barb, Top	S=SIL	200	B=Bar	B=Bidirectional (All Ranges) [All Port Types]			
			001					
	HBO=Horizontal Barb, Opposing	SL= SIL Long	002	I=inH2O				
			005					
			015					
	HBT=Horizontal Barb, Top		030					
			050					
100								
150								
			001					
			002					
			003					
			006					
			0.5					
			001					
			002					
			004					

Part Number Example: **MCT-4A VBTJ005PG51**

**Vertical Barbed Top Port, J Leaded SMT Package, 0 to +5 PSI Range, 5.0Vdc Supply, Pmin=0 PSIG, Pmax=+ 5 PSIG**

### WARRANTY

Pressure sensors have a limited one-year warranty to the original purchaser. AVSensors will repair or replace, at its option, without charge those items it finds defective. This is the buyer's sole remedy and is in lieu of all other warranties, expressed or implied, including those of merchantability and fitness for a particular purpose. In no event shall AVSensors be liable for consequential, special, or indirect damages. This warranty does not apply to units that have been modified, misused, neglected or installed where the application exceeds published ratings. Specifications may change without notice. The information supplied is believed to be accurate and reliable as of this printing, however, we assume no responsibility for its use.