

62CNQ030 SCHOTTKY RECTIFIER

Applications

- Switching power supply
- Converters
- Free-Wheeling diodes
- Reverse battery protection

Features

- 150°C T_J operation
- Center tap module
- Very Low forward voltage drop
- High purity, high temperature epoxy encapsulation for enhanced mechanical strength and moisture resistance
- High frequency operation
- Guard ring for enhanced ruggedness and long term reliability
- Low profile, high current package
- This is a Pb – Free Device
- All SMC parts are traceable to the wafer lot
- Additional electrical and life testing can be performed upon request

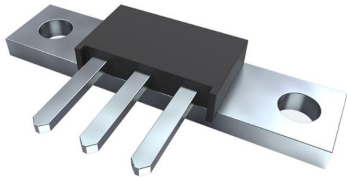
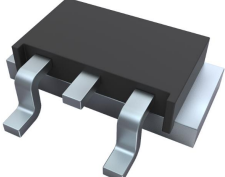
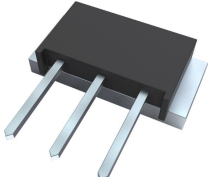
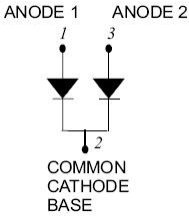
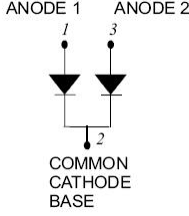
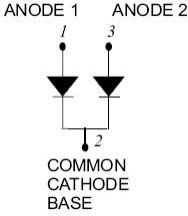
62CNQ030	62CNQ030SL	62CNQ030SM
		
		
PRM3	PRM3-SL	PRM3-SM

Maximum Ratings:

Characteristics	Symbol	Condition	Max.	Units
Peak Repetitive Reverse Voltage Working Peak Reverse Voltage DC Blocking Voltage	V _{RRM} V _{RWM} V _R	-	30	V
Average Rectified Forward Current	I _{F (AV)}	50% duty cycle @T _C =135°C, rectangular wave form	30(Per Leg) 60(Per Device)	A
Peak One Cycle Non-Repetitive Surge Current(Per leg)	I _{FSM}	8.3 ms, half Sine pulse	940	A
Non-Repetitive Avalanche Energy (Peg leg)	E _{AS}	T _J =25°C, I _{AS} =6A, L=1.5mH	27	mJ
Repetitive Avalanche Current(Peg leg)	I _{AR}	Current decaying linearly to zero in 1 μsec Frequency limited by T _J max. V _A =1.5×V _R typical	6	A

- China - Germany - Korea - Singapore - United States •
- <http://www.smc-diodes.com> - sales@smc-diodes.com •

Electrical Characteristics:

Characteristics	Symbol	Condition	Typ.	Max.	Units
Forward Voltage Drop (Per leg) *	V _{F1}	@ 30A, Pulse, T _J = 25 °C	0.45	0.49	V
		@ 60A, Pulse, T _J = 25 °C	0.50	0.53	V
	V _{F2}	@ 30A, Pulse, T _J = 125 °C	0.36	0.39	V
		@ 60A, Pulse, T _J = 125 °C	0.41	0.44	V
Reverse Current (Per leg) *	I _{R1}	@V _R = rated V _R T _J = 25 °C	0.17	5	mA
	I _{R2}	@V _R = rated V _R T _J = 125 °C	38	280	mA
Junction Capacitance (Per leg)	C _T	@V _R = 5V, T _C = 25 °C f _{SIG} = 1MHz	2800	3700	pF
Voltage Rate of Change	dv/dt	-	-	10,000	V/μs

* Pulse width < 300 μs, duty cycle < 2%

Thermal-Mechanical Specifications:

Characteristics	Symbol	Condition	Specification	Units
Junction Temperature	T _J	-	-55 to +150	°C
Storage Temperature	T _{stg}	-	-55 to +150	°C
Typical Thermal Resistance Junction to Case (per leg)	R _{θJC}	DC operation	0.5	°C/W
Typical Thermal Resistance Junction to Case (per package)	R _{θJC}	DC operation	0.25	°C/W
Typical Thermal Resistance, case to Heat Sink	R _{θcs}	Mounting surface, smooth and greased	0.21	°C/W
Mounting Torque	TM	-	40(min)	Kg-cm
			58(max)	
Case Style	PRM3 PRM3-SL PRM3-SM			

Ratings and Characteristics Curves

Figure 1
Typical Forward Characteristics

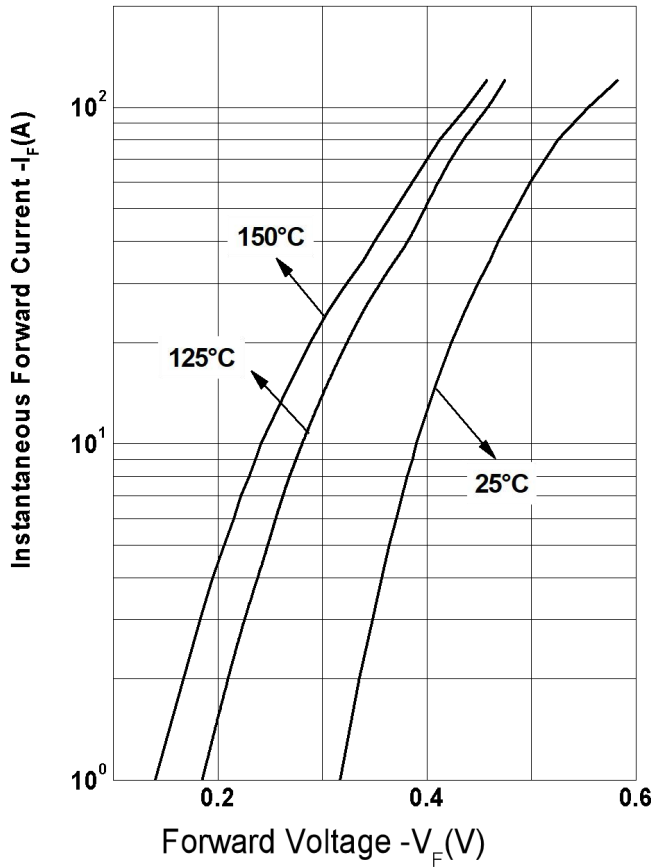

Figure 2
Typical Reverse Characteristics

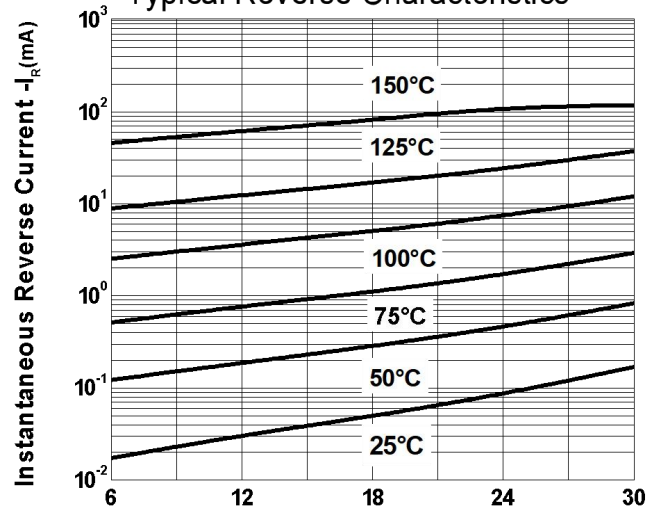
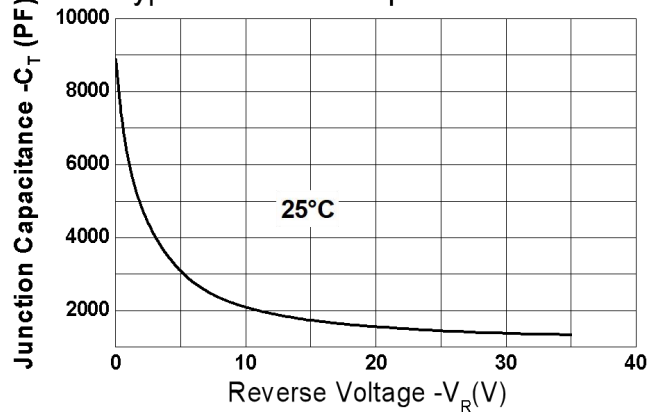
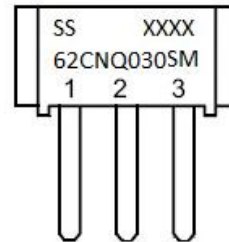
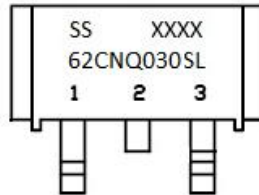
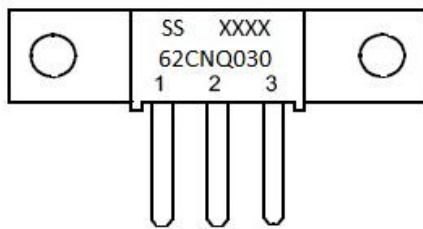

Figure 3
Typical Junction Capacitance



Marking Diagram



Where XXXX is YYWW

1st row SS YYWWL
2nd row 62CNQ030/SL/SM
3rd row 1 2 3 (pin)
SS = SS
YY = Year
WW = Week

Cautions: Molding resin
Epoxy resin UL:94V-0

Ordering Information

Device	Package	Approximate Weight(g)	Terminals finish	Baseplate finish	Shipping
62CNQ030	PRM3	8.6	Nickel plated	Nickel plated	48pcs / box
62CNQ030S2	PRM3	8.6	Pure Sn dipped (dipped heigh 6-8mm)	Nickel plated	48pcs / box
62CNQ030SL	PRM3-SL	5.3	Pure Sn plated	Pure Sn plated	100pcs / box
62CNQ030SM	PRM3-SM	5.6	Nickel plated	Nickel plated	48pcs / box
62CNQ030SMS2	PRM3-SM	5.6	Pure Sn dipped (dipped heigh 6-8mm)	Nickel plated	48pcs / box

Mechanical Dimensions PRM3 (Inches/Millimeters)

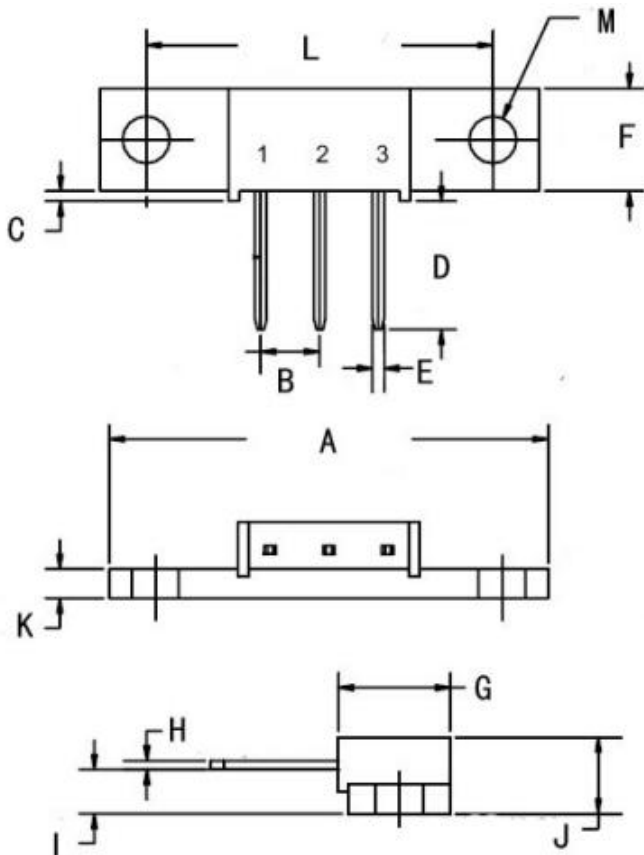

SYMBOL	Millimeters		Inches	
	Min.	Max.	Min.	Max.
A	37.72	38.23	1.485	1.506
B	5.08		0.200	
C	0.62	1.02	0.024	0.040
D	10.38	12.98	0.408	0.511
E	0.88	1.22	0.034	0.048
F	8.46	9.06	0.333	0.357
G	9.24	9.85	0.363	0.388
H	0.61	0.92	0.024	0.037
I	3.19	4.19	0.125	0.165
J	6.95	7.55	0.273	0.298
K	2.40	2.60	0.094	0.103
L	29.51	30.40	1.161	1.197
M	3.75	4.33	0.147	0.171

Mechanical Dimensions PRM3-SL (Inches/Millimeters)

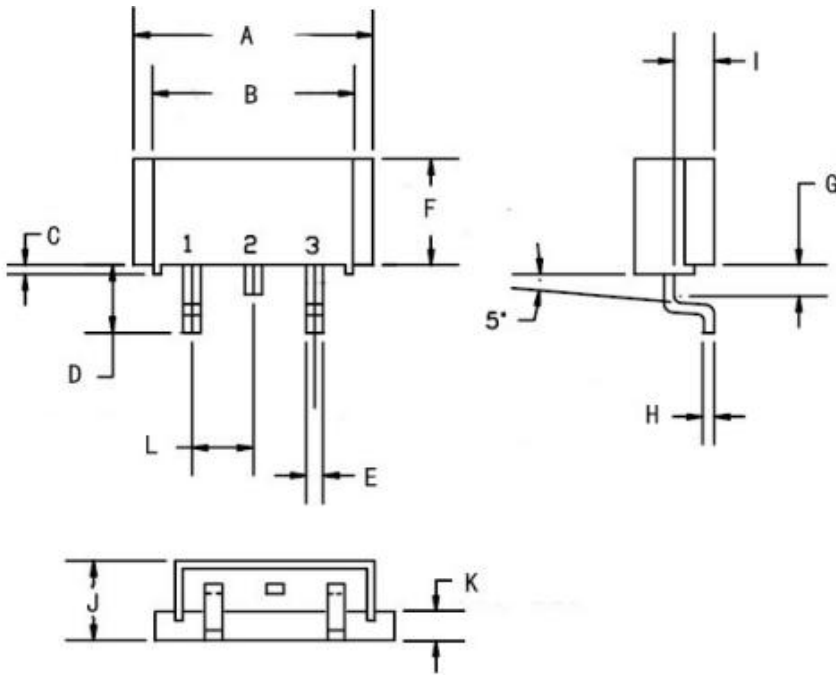

SYMBOL	Millimeters		Inches	
	Min.	Max.	Min.	Max.
A	19.70	20.30	0.776	0.799
B	16.51	17.02	0.650	0.670
C	0.62	1.02	0.024	0.040
D	4.97	5.97	0.196	0.235
E	0.88	1.22	0.034	0.048
F	8.46	9.06	0.333	0.357
G	2.04	2.54	0.080	0.100
H	0.61	0.92	0.024	0.037
I	3.19	4.19	0.125	0.165
J	6.95	7.55	0.274	0.297
K	2.21	2.71	0.087	0.106
L	5.08		0.200	

Mechanical Dimensions PRM3-SM (Inches/Millimeters)

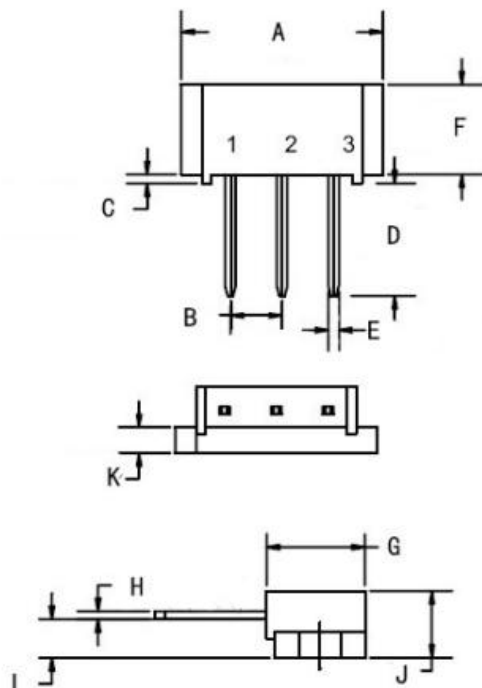

SYMBOL	Millimeters		Inches	
	Min.	Max.	Min.	Max.
A	19.70	20.30	0.776	0.799
B	5.08		0.200	
C	0.62	1.02	0.024	0.040
D	10.38	12.98	0.408	0.511
E	0.88	1.22	0.034	0.048
F	8.46	9.06	0.333	0.357
G	9.24	9.85	0.363	0.388
H	0.61	0.92	0.024	0.037
I	3.19	4.19	0.125	0.165
J	6.95	7.55	0.273	0.298
K	2.40	2.60	0.094	0.103

DISCLAIMER:

- 1- The information given herein, including the specifications and dimensions, is subject to change without prior notice to improve product characteristics. Before ordering, purchasers are advised to contact the SMC Diode Solutions sales department for the latest version of the datasheet(s).
- 2- In cases where extremely high reliability is required (such as use in nuclear power control, aerospace and aviation, traffic equipment, medical equipment, and safety equipment), safety should be ensured by using semiconductor devices that feature assured safety or by means of users' fail-safe precautions or other arrangement.
- 3- In no event shall SMC Diode Solutions be liable for any damages that may result from an accident or any other cause during operation of the user's units according to the datasheet(s). SMC Diode Solution assumes no responsibility for any intellectual property claims or any other problems that may result from applications of information, products or circuits described in the datasheets.
- 4- In no event shall SMC Diode Solutions be liable for any failure in a semiconductor device or any secondary damage resulting from use at a value exceeding the absolute maximum rating.
- 5- No license is granted by the datasheet(s) under any patents or other rights of any third party or SMC Diode Solutions.
- 6- The datasheet(s) may not be reproduced or duplicated, in any form, in whole or part, without the expressed written permission of SMC Diode Solutions.
- 7- The products (technologies) described in the datasheet(s) are not to be provided to any party whose purpose in their application will hinder maintenance of international peace and safety nor are they to be applied to that purpose by their direct purchasers or any third party. When exporting these products (technologies), the necessary procedures are to be taken in accordance with related laws and regulations..