

0.5mm Pitch
SERIES

6292

0.5mmピッチ RA SMT 上接点 スライドロック
0.5mmPitch RA SMT Top contact Slide lock

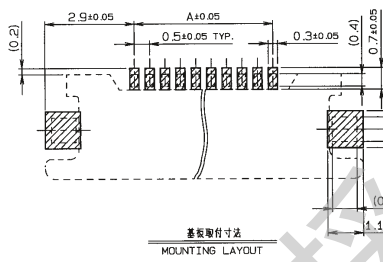
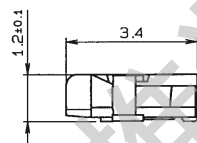
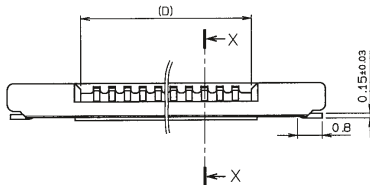
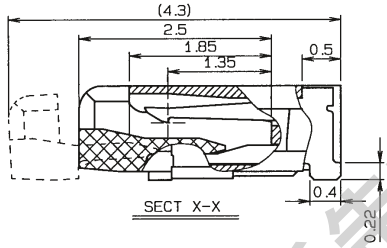
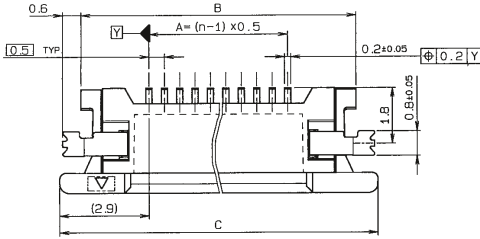

	FPC		FFC	
	1	2	1	2
M	0.5±0.12	0.5±0.1	0.5±0.1	0.5±0.08
P	0.5±0.02	0.5±0.05	0.5±0.03	0.5±0.05
A	A±0.03	A±0.05	A±0.03	A±0.05
W	W±0.07	W±0.07	W±0.07	W±0.07
Wp	0.35 ^{+0.04} _{-0.03}	0.35±0.05	0.3 ^{+0.05} _{-0.02}	0.3 ^{+0.05} _{-0.02}

適用FPC, FFC寸法
APPLICABLE FPC, FFC

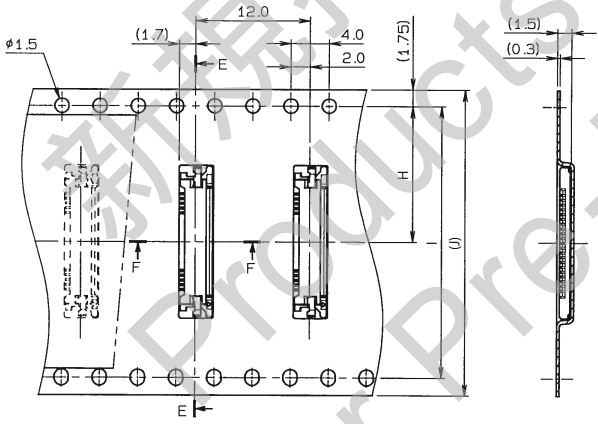
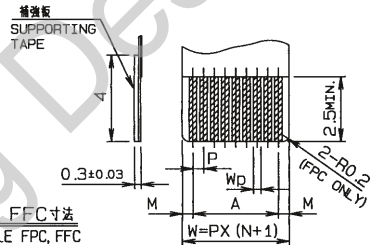

SECT. E-E

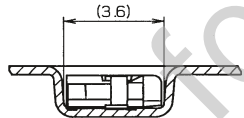

SECT. F-F

極数 NO. OF POS.	H	I	J
5	11.5	—	24
6	11.5	—	24
7	11.5	—	24
8	11.5	—	24
9	11.5	—	24
10	11.5	—	24
11	11.5	—	24
12	11.5	—	24
13	11.5	—	24
14	11.5	—	24
15	11.5	—	24
16	11.5	—	24
17	11.5	—	24
18	11.5	—	24
19	11.5	—	24
20	11.5	—	24
21	14.2	28.4	32
22	14.2	28.4	32
23	14.2	28.4	32
24	14.2	28.4	32
25	14.2	28.4	32
26	14.2	28.4	32
27	14.2	28.4	32
28	14.2	28.4	32
29	14.2	28.4	32
30	14.2	28.4	32

極数 NO. OF POS.	A	B	C	D
5	20	64	7.8	3.1
6	25	69	8.3	3.6
7	30	74	8.8	4.1
8	35	79	9.3	4.6
9	40	84	9.8	5.1
10	45	89	10.3	5.6
11	50	94	10.8	6.1
12	55	99	11.3	6.6
13	60	104	11.8	7.1
14	65	109	12.3	7.6
15	70	114	12.8	8.1
16	75	119	13.3	8.6
17	80	124	13.8	9.1
18	85	129	14.3	9.6
19	90	134	14.8	10.1
20	95	139	15.3	10.6
21	100	144	15.8	11.1
22	105	149	16.3	11.6
23	110	154	16.8	12.1
24	115	159	17.3	12.6
25	120	164	17.8	13.1
26	125	169	18.3	13.6
27	130	174	18.8	14.1
28	135	179	19.3	14.6
29	140	184	19.8	15.1
30	145	189	20.3	15.6

注文コード ORDERING CODE
04 6292 0XX 000 XXX+

RoHS 対応品
RoHS Compliant Product

800+ : スズ銅めっき Sn-Cu Plated
829+ : 金めっき Au Plated

極数 NUMBER OF POSITIONS

生産対応可能極数については、営業部にご確認願います。
Feel free to contact our sales department for available numbers of positions.

梱包数量 2000個/リール
PACKING QUANTITY : 2000/Reel