

TOLERANCE UNLESS OTHERWISE SPECIFIED	
.X	±---
.XX	±---
.XXX	±.005

THIS IS A C.A.D. GENERATED DRAWING
DO NOT MAKE MANUAL REVISIONS TO MASTER.

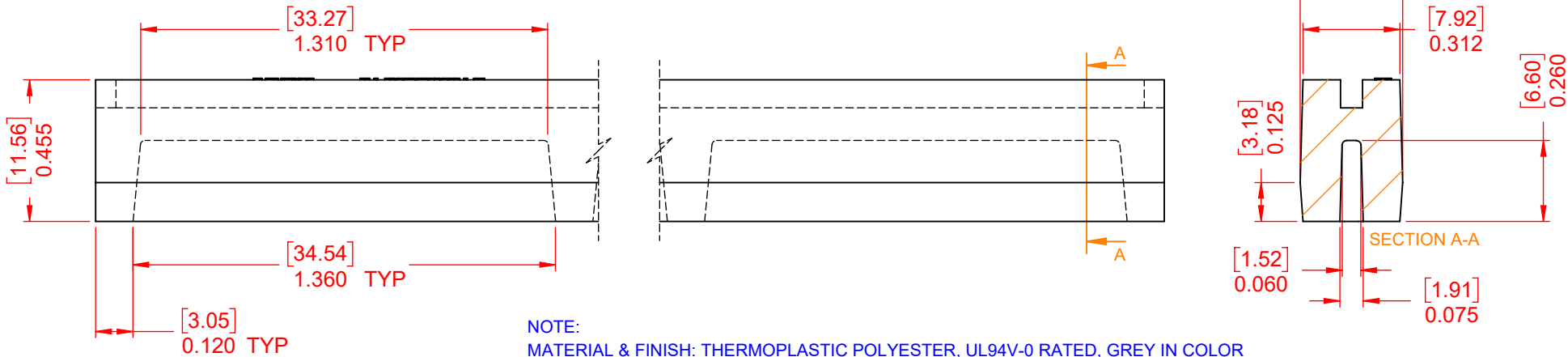

ISSUE NUMBER	
ORIGINAL	①
CONVERTED TO SW2020 C.B AUG, 20/2020	②

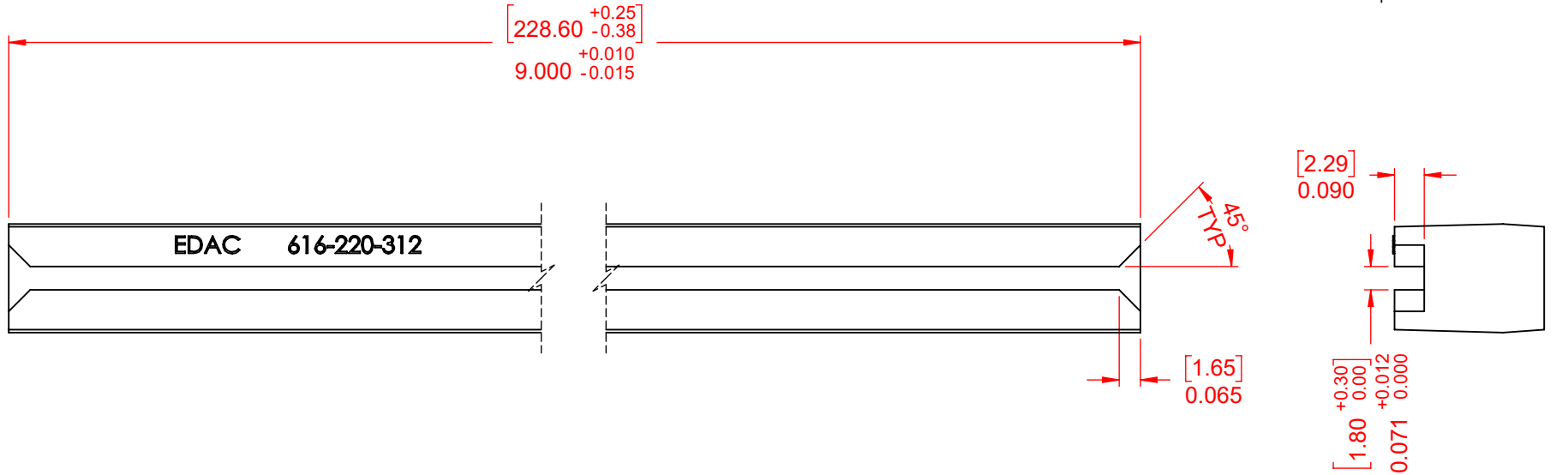

NOTE:
MATERIAL & FINISH: THERMOPLASTIC POLYESTER, UL94V-0 RATED, GREY IN COLOR



THIS SERIES FULLY CONFORMS TO
THE EUROPEAN UNION DIRECTIVES
2011/65/EU FOR RoHS COMPLIANCY.



YOUR CONNECTION TO QUALITY & SERVICE

EDAC INC
TORONTO, ONTARIO
CANADA

THESE DRAWINGS AND SPECIFICATIONS
ARE THE PROPERTY OF EDAC INC., AND
SHALL NOT BE REPRODUCED, OR COPIED
OR USED AS THE BASIS FOR THE
MANUFACTURE OR SALE OF APPARATUS
WITHOUT WRITTEN PERMISSION.

616 SERIES UNI-GUIDE

ACAD REFERENCE NO.: 616-220-001	
DRAWN: F. BIRONES	DATE: APR, 17/1997
CHECKED:	DATE:
SCALE: 2:1	SHEET 1 OF 1
DRAWING NUMBER: 616-220-001	ISSUE
PART NUMBER: 616-220-312	23