

## Beam0412-172-Blue (4-Pack)

SKU: 60719 Weight: 62.40 Gram

### What Are Beams?

Beams are the most frequently-used parts of Makeblock platform which can be used to build all kinds of mechanical structures. Beam 0412 series is usually applied as linking-rod parts and comes with different length varying from 36mm to 236mm for various building needs.

### Versatile Usage

- Works perfectly with Plastic Gear, Timing Pulley, other wheel-related parts, and motor shafts;
- Build various linking-rod structures thru different combinations;
- Can be used with angular sensor to enables angle feedback between 2 linking-rod parts;
- Equipped with slots for easy and flexible connection with Beam 0808 & 0824.

# Design & Material

- Compatible with most Makeblock motions and structure components;
- Made from heavy-duty 6061 aluminum extrusion with anodized surface for long-time use;
- With 4mm diameter through-holes on 16mm increments.

## Note

This page is for Beam 0412-172 with length of 172mm. For other configuration, please search Beam 0412 in our website.

## Building Examples:

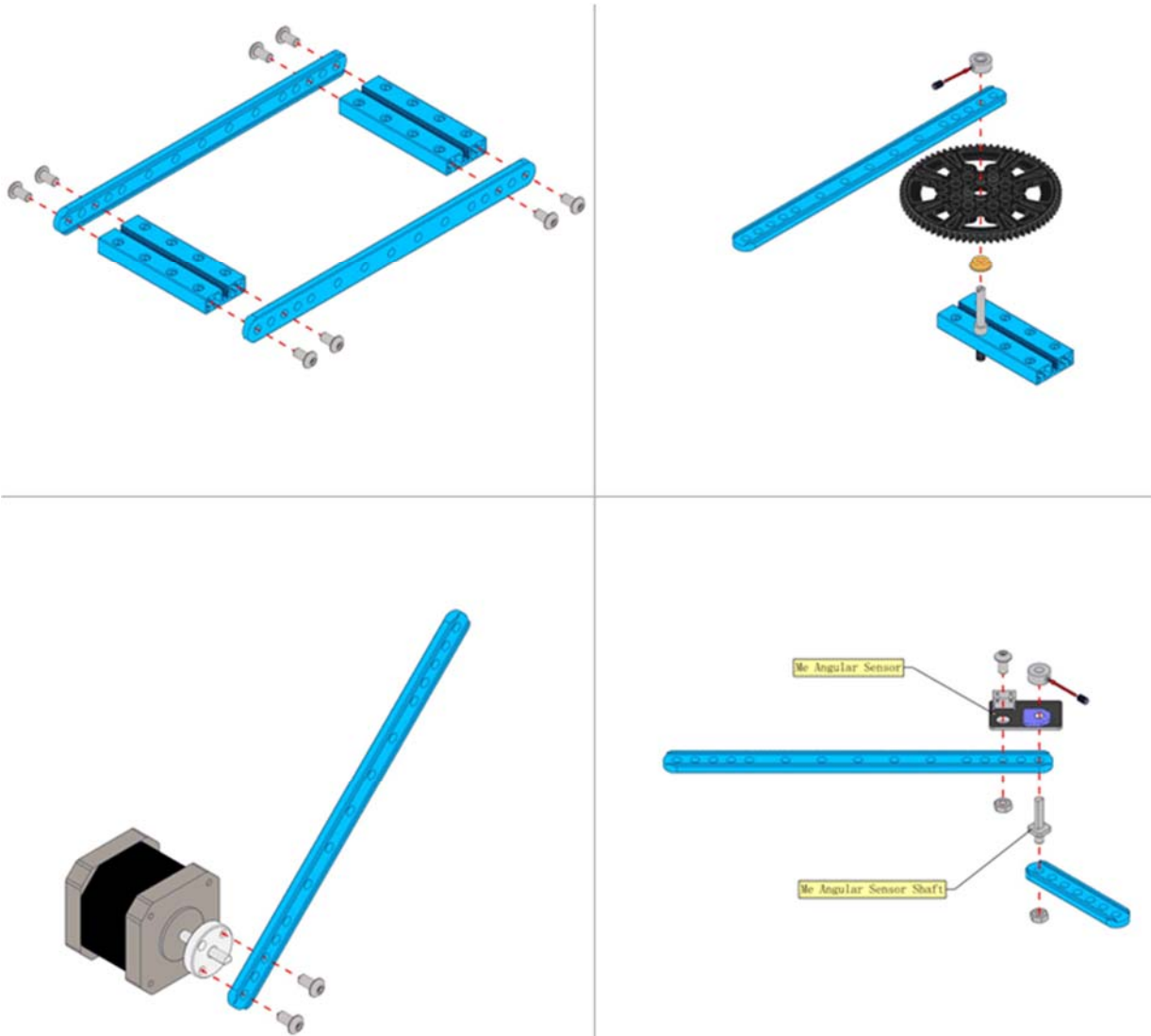

## Size Chart (mm):

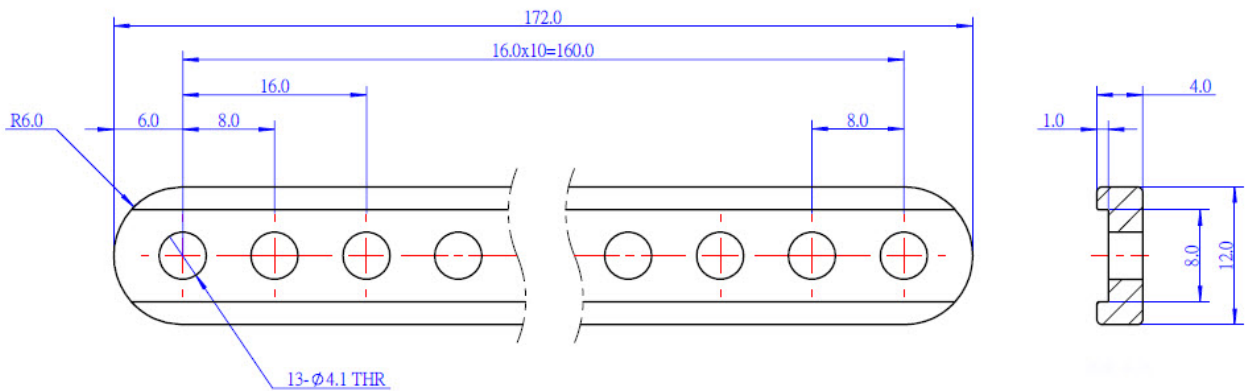

## Specifications

SKU	60719
Material	6061 Aluminum
Diameter of holes	4mm
Cross-section area	4 x 12mm
Length	172mm
Package content	4 x Beam 0412-172
Dimension	172 x 12 x 4mm (6.77 x 0.47 x 0.16")
Net Weight	62.4g (2.2oz)