

** Not all features are shown in this drawing. For more detailed information, please contact your Fair-Rite representative.

UNCONTROLLED ~CATALOG~ DRAWING

SIZE	PART NO.	REV.
B	5979000301	~

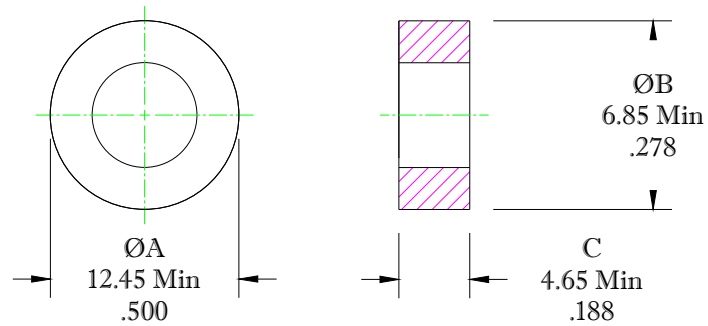

DIMENSIONS
BOLD DIMENSIONS ARE IN MILLIMETERS
 LIGHT DIMENSIONS ARE IN INCHES.

ELECTRICAL SPECIFICATIONS						
$\Sigma l/A(\text{mm}^2)$	$l_e (\text{mm})$	$A_e (\text{mm}^2)$	$V_e (\text{mm}^3)$	$L_o (\text{nH})$	$A_L (\text{nH})$ @10 kHz <10gauss	$\tan \delta/\mu$ i @100 kHz 1gauss
2.214	29.2	13.2	385	0.5679	794±25%	≤15X10E-6

NOTES:

1 - BURNISH TO BREAK SHARP EDGES.

FR# 79

FAIR-RITE PRODUCTS CORP.						
TITLE TOROID						
DRAWN BY A. BARTLETT	DATE 07-19-22	SIZE B	PART NO. 5979000301		REV. ~	
CHKD BY		APPRVD BY	SCALE NONE	SHEET 1 of 1		