

THIS IS A C.A.D. GENERATED DRAWING  
DO NOT MAKE MANUAL REVISIONS TO MASTER.

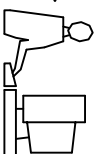

ISSUE NUMBER  
ORIGINAL

①

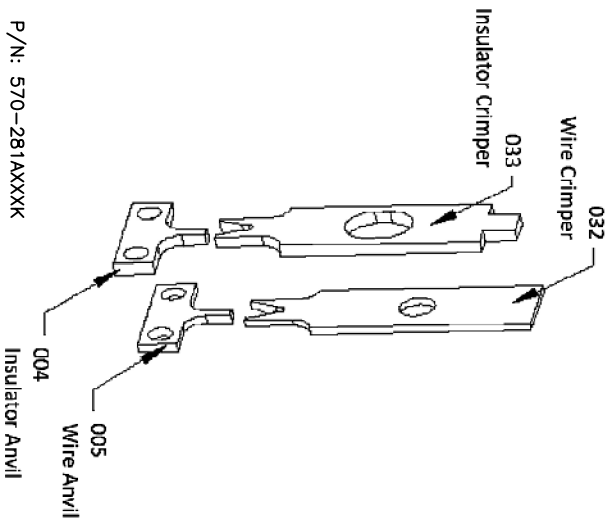
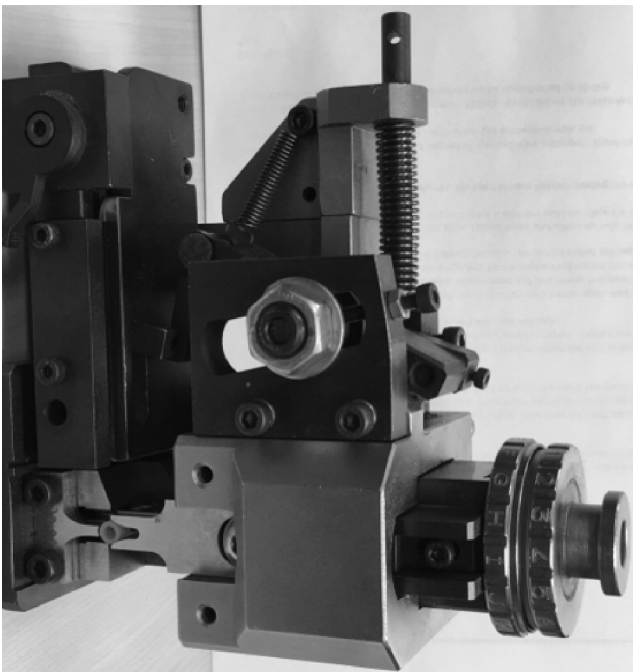

PRESS TYPE	K PRESS
STROKE LENGTH	30.00 MM
SHUT HEIGHT	119.55 MM
AWG	14-22

REPLACEMENT PUNCH & DIE PARTS			
INSULATOR ANVIL	WIRE ANVIL	WIRE CRIMPER	INSULATOR CRIMPER
570-281A004K	570-281A005K	570-281A032K	570-281A033K

- NOTES:
- 1- THIS APPLICATOR IS DESIGNED TO BE USED ON A K CRIMPING MACHINE.
  - 2- THIS APPLICATOR IS DESIGNED FOR CRIMPING EDAC CONTACT P/N 570-290-711.
  - 3- FOR THE DEFINITION OF STROKE LENGTH AND SHUT HEIGHT, APPLICATOR SETUP AND OPERATING INSTRUCTION, PLEASE REFER TO DOCUMENT "APPLICATOR INSTRUCTION MANUAL K PRESS".

K PRESS APPLICATOR FOR 570-290-711

ACAD REFERENCE NO. 570-280-751K

DRAWN: K.L. DATE: OCT.29/2020

CHECKED: R.S.M. DATE: OCT.29/2020

SCALE: N.T.S. SHEET 1 OF 1

DRAWING NUMBER 570-280-751K ISSUE 1



EDAC INC  
TORONTO, ONTARIO  
CANADA

YOUR CONNECTION TO QUALITY & SERVICE

THESE DRAWINGS AND SPECIFICATIONS ARE THE PROPERTY OF EDAC INC. AND SHALL NOT BE REPRODUCED, OR COPIED OR USED AS THE BASIS FOR THE MANUFACTURE OR SALE OF APPARATUS WITHOUT WRITTEN PERMISSION.