



**GEDORE** 

No. 407 A

**B-METALL**

Made in UE

# WORKSHOP SUPPLIES

## AUTOMOTIVE TOOLS

>534



## EQUIPMENT

>551



## FILES, SAWS

>552



## VARIOUS

>553



## PARALLEL VICES

>554



## MEASURING TOOLS

>554



## THREAD WORKINGS

>557



## INDUSTRIAL CUTLERY

>562



## AT WORK

>565



## Tyre fitting / removal

- > For the controlled tightening of wheel nuts or studs, we recommend torque wrenches
- > For truck wheels, we specially recommend the DR-LKW torque wrench



## FOUR-WAY WHEEL WRENCH

- > Hot forged hexagon
- > The collar, typical of GEDORE 4-way wheel wrenches, enlarges the welding area.
- > The positive-fit joint remains solid even under extreme loading..

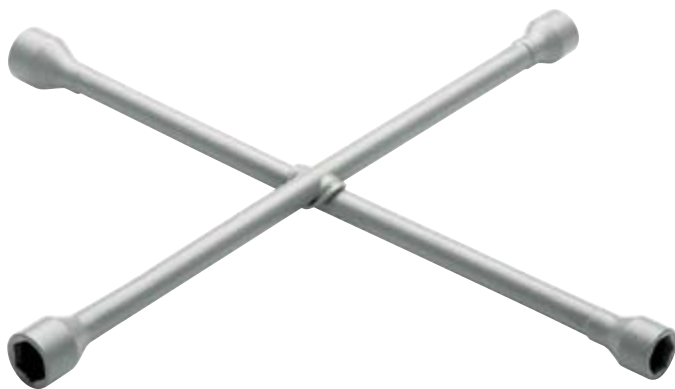

### 28 CU 4-WAY WHEEL WRENCH FOR SMALL TRUCKS

- > For delivery vans and light trucks, buses and tractors
- > Acc. to DIN 3119, ISO 6788
- > GEDORE vanadium steel 31CrV3
- > GEDORE grey powder-coated
- > Dimensions: 600 x 600 mm



mm	mm	kg	Code	No.
19x24x22x27 (3/4x15/16x7/8x1.1/16")	28,5x32x34,5x38,5	3.155	6228500	28 CU

### 28 LM - LV 4-WAY WHEEL WRENCH FOR TRUCKS



- > For trucks, agricultural machines, tractors and industrial uses
- > Acc. to DIN 3119, ISO 6788
- > GEDORE vanadium steel 31CrV3
- > GEDORE grey powder-coated
- > Dimensions: 750 x 750 mm



mm	mm	kg	Code	No.
24x27x30x32	34,5x38,5x42x45	5.555	6228770	28 LM
24x32x27x3/4" 4kt	34,5x45x38,5x26	5.515	6229150	28 LV

## 28 LR + 28 LRV 4-WAY WHEEL WRENCH FOR TRUCKS

- > For trucks and heavy machines
- > With turned centre, especially sturdy
- > GEDORE vanadium steel 31CrV3, chrome-plated
- > Dimensions: 750 x 750 mm



Ø mm	Ø mm	kg	Code	No.
27x30x32x33	40x44x46x46	6.085	6228930	28 LR
27x30x32x3/4" 4kt	40x44x46x26	5.980	6228420	28 LRV

## 28 PKH 2-WAY WHEEL WRENCH FOR CARS

- > An indispensable tool for all usual car wheel nuts
- > With a protective central reinforcement (DBGM = German utility patent)
- > Practical and strong, with long lever arm, a space-saver in the car boot
- > GEDORE vanadium steel 31CrV3, chrome-plated
- > Dimensions: 410 x 260 mm



Ø mm	Ø mm	kg	Code	No.
17x19 (3/4")	26x28,5	1.020	6227290	28 PKH

## 28 PR + 28 PRV UNIVERSAL 4-WAY WHEEL WRENCH

for cars and small trucks

- > Acc. to DIN 3119, ISO 6788
- > With solid turned centre, for the car and truck workshop
- > With extra long lever arm and great range of sockets
- > GEDORE vanadium steel 31CrV3, chrome-plated
- > Dimensions: 550 x 550 mm

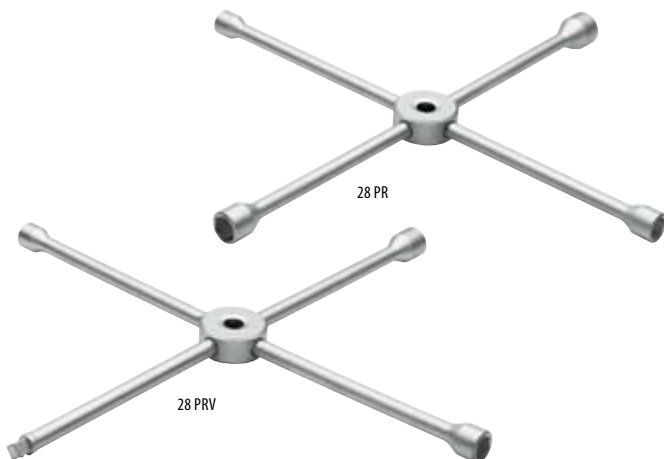

Ø mm	Ø mm	kg	Code	No.
17x19 (3/4")x21x24	26x28,5x30,5x35,5	2.315	6227530	28 PR
17x19 (3/4")x21x1/2" 4kt	26x28,5x30,5x17,5	2.255	6227880	28 PRV

## 28 PU + 28 PUV 4-WAY WHEEL WRENCH FOR CARS

- > For car wheel nuts in metric and inch sizes
- > Acc. to DIN 3119, ISO 6788
- > With protective central reinforcement (DBGM = German utility patent)
- > GEDORE vanadium steel 31CrV3
- > GEDORE grey powder-coated
- > Dimensions: 420 x 420 mm

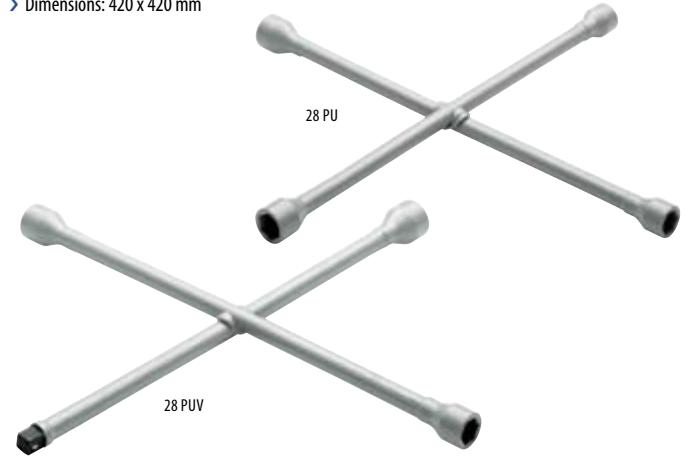

Ø mm	Ø mm	kg	Code	No.
17x19 (3/4")x21x11/16"	26x28,5x30,5x26	1.285	6227610	28 PU
17x19 (3/4")x21x1/2" 4kt	26x28,5x30,5x17,5	1.315	6228260	28 PUV

## 27 WHEEL SOCKET WRENCH FOR TRUCKS

- > With great head depth, for protruding bolts, without tommy bar
- > GEDORE vanadium steel 31CrV3, chrome-plated
- > Please order tommy bar 27 D separately

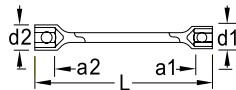

mm	"AF	L	a <sub>1</sub>	a <sub>2</sub>	d <sub>1</sub>	d <sub>2</sub>	Ø	kg	Code	No.
24 x 27	15/16 x 1.1/16	400	34.5	34.5	36	40	1.148	6225240	27 24x27	
27 x 32		400	34.5	34.5	40	46	1.453	6220010	27 27x32	
28 x 32		400	34.5	34.5	41	46	1.134	6220280	27 28x32	
30 x 32	1.3/16 x 1.1/4	400	34.5	34.5	44	46	1.459	6225910	27 30x32	
30 x 33		400	34.5	34.5	44	47	1.442	6220440	27 30x33	
		630					18	1.260	6227100	27 D

## 8276 BALANCE WEIGHT PLIERS

- > For removing, cutting, and attaching balancing weights
- > GEDORE vanadium steel 31CrV3



mm	inch	kg	Code	No.
250	10	0.386	6739350	8276-250 C

K 19 LS / K 19 LS-004

>238



## 38 TYRE LEVER

- > Profiled pattern, forged from solid stock
- > With protective surfaces for light-alloy wheels
- > GEDORE vanadium steel 31CrV3, chrome-plated



mm	inch	kg	Code	No.
200	8	0.099	6332320	38 8
305	12	0.221	6332400	38 12
400	16	0.405	6332670	38 16
500	20	0.602	6332830	38 20
610	24	0.927	6332910	38 24

## 39 TYRE LEVER

heavy-duty pattern

- > Heavy-duty, offset pattern
- > GEDORE vanadium steel 31CrV3, chrome-plated



mm	inch	kg	Code	No.
610	24	1.365	6333050	39

## Brakes

### 135 BRAKE SPRING PLIERS

- > For drum brakes
- > With special holder and support crown, particularly suitable for glued brake linings
- > GEDORE vanadium steel 31CrV3, chrome-plated



↳ mm ↲	↳ inch ↲	⚖️	Code	No.
330	13	0.389	6405300	135 13
480	19	0.956	6405490	135 19

### 135 BRAKE SPRING PLIERS

heavy-duty pattern

- > For drum brakes
- > With replaceable spring hooks (E-135 20) and hand protectors
- > GEDORE vanadium steel 31CrV3, chrome-plated



↳ mm ↲	↳ inch ↲	⚖️	Code	No.
500	20	1.058	6400180	135 20
		0.016	5400480	E-135 20

### 643 BRAKE CALIPER BRUSH

- > For cleaning all brake calipers
- > With blue plastic handle



↳ mm ↲	Bristle length	⚖️	Code	No.
225	21	0.094	6531440	643

### 8726 BRAKE CALIPER FILE



↳ mm ↲	↳ inch ↲	⚖️	Code	No.
260	10	0.131	6770780	8726

## Oil service

### 298 OIL CAN

- > 298-00 / 298-01 Plastic oil can with sliding brass tube and cap
- > 298-02 simple oil can in plastic



298-00



298-01



298-02

Litre	Pint	⚖️	Code	No.
0.250	1/2	0.979	6390010	298-00
0.125	1/4	0.074	6390280	298-01
0.025	1/16	0.010	6390360	298-02

### 298-04 OIL CAN

- > Strong, cast iron pattern with pump, 300 ml



Litre	Pint	⚖️	Code	No.
0.3	5/8	0.492	6390520	298-04

### 299 DRAIN PLUG WRENCH

- > For square plugs on engine sumps and oil drums, in nine common sizes
- > GEDORE vanadium steel 31CrV3, chrome-plated
- > 5 square sizes: 8.7, 9.5, 10.5, 11.5, 13 mm
- > 4 tapered sizes: 6.8-8.7, 10.5-13, 15.2-18, 16.5-19 mm
- > One screwdriver blade: 5.5 x 18 mm



↳ mm ↲	⚖️	Code	No.
220	0.459	6464580	299

## V-Belts / Filters

## 36 STRAP WRENCH

- > With strong, non-slip fabric strap (E-36), extra wide = 25 mm
- > 36 1-140 made from C45 steel
- > 36 2-200 made from GEDORE vanadium steel 31CrV3
- > Chrome-plated



36 2-200

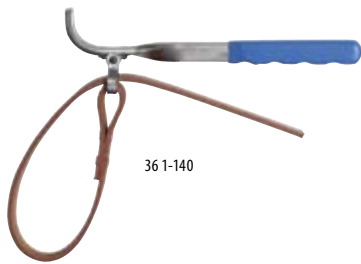

36 1-140

Ø mm	Ø inch	↳ mm ▷	mm	⚖ kg	Code	No.
140	5.1/2	220	25	0.278	6327320	36 1-140
200	8	285	25	0.578	6327400	36 2-200

## 37 UNIVERSAL FILTER WRENCH

- > For all usual oil filters and round screwed unions
- > Adjustable metal strap, nickel-plated
- > With handle



mm	↳ mm ▷ (appr.)	⚖ kg	Code	No.
80-110	285	0.349	6327670	37

## E-36 SPARE STRAP

- > Strong, non-slip fabric strap, extra wide = 25 mm



↳ mm ▷	mm	⚖ kg	Code	No.
480	25	0.062	5327380	E-36 1-140
900	25	0.104	5327460	E-36 2-200

## 36 Z SPECIAL STRAP WRENCH

- > For tightening and counter-holding V-belt pulley wheels
- > Spare strap E-36 Z



↳ mm ▷	Ø mm	Ø inch	⚖ kg	Code	No.
257	160	6	0.379	6320070	36 Z-140

## E-36 Z SPARE STRAP

↳ mm ▷	⚖ kg	Code	No.
257	0.080	1380613	E-36 Z-140

## 37 V UNIVERSAL FILTER WRENCH

- > For all usual oil filters and round screwed unions
- > Adjustable metal strap, nickel-plated
- > With 1/2" square drive for all 1/2" tools



mm	↳ mm ▷ (appr.)	⚖ kg	Code	No.
80-110	150	0.265	6327750	37 V

Pistons / Valves

## 654 VALVE GRINDER

- > With automatic reversal of lapping direction
- > For use in hand drills
- > Supplied with suction cups 652-20, -25, -30, -37



∅ mm	l mm	kg	Code	No.
65	135	0.750	6535270	654

## 653 VALVE LAPPING TOOL

- > Hand-held type with suction cup 652-25
- > Beech wood handle



∅ mm	l mm	kg	Code	No.
25	225	0.050	6532680	653

## 652 SPARE RUBBER SUCTION CUP for 653 and 654



∅ mm	l mm	kg	Code	No.
20	38	0.010	6530120	652-20
25	38	0.011	6532410	652-25
30	38	0.012	6530200	652-30
37	38	0.016	6530390	652-37

## 124 PLIERS FOR VALVE SEALS

- > For pulling valve shaft sealing rings and removing valve spring supports
- > For VW Audi, BMW, Mercedes, Opel, Ford, Nissan etc.
- > Gun-metal finish, handles chrome-plated



l mm	l inch	kg	Code	No.
250	10	0.348	6399310	124

## 128 VALVE SPRING COMPRESSOR

- > For overhead valve engines
- > With one pair each of straight and offset hooks
- > Bright nickel-plated



l mm	l inch	mm	inch	kg	Code	No.
290	11.1/2	60-225	2.3/8-9	1.326	6398500	128 2-225
390	15	120-280	4.3/4-11.1/2	3.200	6398690	128 1-280



## 125 PISTON RING COMPRESSOR

- > In special band spring steel, with continuous adjustment
- > With clamping wrench



125 0

125 1 / 125 2

125 3

Ø mm	↳ mm ▶	↳ "inch ▶	⚖ kg	Code	No.
40-75	50	2	0.115	6396720	125 0
57-125	80	3	0.257	6396800	125 1
90-175	80	3	0.294	6396990	125 2
90-175	165	6.1/2	0.548	6397020	125 3

## 126 PISTON RING PLIERS

- > With prism holder for secure fitting of piston rings
- > With adjusting screw
- > Bright nickel-plated



Ø mm	↳ mm ▶	↳ "inch ▶	⚖ kg	Code	No.
30-60	210	8.1/4	0.158	6397100	126 0-60

## 126 PISTON RING PLIERS

- > For securely fitting piston rings
- > Handles blue coated
- > Bright nickel-plated



Ø mm	↳ mm ▶	↳ "inch ▶	⚖ kg	Code	No.
55-100	200	8	0.296	6397370	126 1-100
80-120	240	9.1/2	0.344	6397450	126 2-120
110-160	240	9.1/2	0.402	6397530	126 3-160

## 127 PISTON RING PLIERS

- > With prism holder for safe piston ring spreading
- > In special steel
- > Prism holders hardened
- > Chrome-plated, tips gun-metal finish



Ø mm	↳ mm ▶	↳ "inch ▶	⚖ kg	Code	No.
60-160	220	8.5/8	0.207	6397610	127

## Pistons / Valves

## 132 HOSE CLAMP PLIERS

- > For self-clamping hose clamps
- > Handles chrome-plated



↳ mm ▶	↳ "inch ▶	⚖ kg	Code	No.
220	8.3/4	0.215	6399900	132

## 132-2 HOSE CLAMP PLIERS

- > Rotating v-jaws for spring hose clamps with flat butt ends
- > The pliers allow the clamp to be opened and closed without damaging the hose, even in hard-to-reach areas
- > For use on VAG-vehicles (e.g. VW, Audi, Škoda, Seat)
- > Made from steel sheet, nickel-plated



↳ mm ▶	⚖ kg	Code	No.
207	0.192	1894382	132-2

## 132-3 HOSE CLAMP PLIERS

- > Rigid v-jaws
- > For use on VAG-vehicles (e.g. VW, Audi, Škoda, Seat)
- > Made from steel sheet, nickel-plated



↳ mm	⚖️	Code	No.
195	0.165	1894390	132-3

## 132-4 HOSE CLAMP PLIERS CLIC

- > With revolving locking bolts for CLIC hose clamps
- > To open or close, just turn the plier by 180 degrees
- > The pivotable bolts enable the usage even in hard-to-reach areas
- > CLIC hose clamps are used on rubber and silicone hoses (e.g. automotive industry for fuel-, oil- and cooler-systems)
- > Made from steel sheet, nickel-plated



↳ mm	⚖️	Code	No.
210	0.181	1894404	132-4

## 132 CLIC HOSE CLAMP PLIERS

- > For CLIC-R hose clamps
- > Polished, bright nickel-plated, joint gun-metal finish
- > Forged execution for clamp diameter 5 - 30 mm



↳ mm	↳ inch	⚖️	Code	No.
180	7	0.247	1396714	132 CLIC

## 134 HOSE CLAMP PLIERS

- > With self-adjusting joint, DBGM (= German utility patent)
- > Angled jaw
- > Bright nickel-plated, joint gun-metal finish



↳ mm	↳ inch	⚖️	Code	No.
180	7	0.411	6391330	134

## 134 B HOSE CLAMP PLIERS

- > Bowden-cable operation
- > With self-adjusting joint, DBGM (= German utility patent)
- > Angled jaw
- > Bright nickel-plated, joint gun-metal finish



↳ mm	↳ inch	⚖️	Code	No.
180	7	0.596	6390950	134 B

## 8272 UNIVERSAL PLIERS

- > With adjustable joint and protection against clamping
- > Non-slip handles, slightly angled jaw position
- > In heat-treated steel as per EN 10083





↳ mm	↳ inch	⚖️	Code	No.
165	6	0.189	6738620	8272-165 C
200	8	0.259	6738890	8272-200 C

## Voltage tester

4610  
CAR LIGHT TESTER

- > For testing 6-24 Volt
- > Compact brass model
- > With cable and alligator crimp







Measuring range			Code	No.
6-24 V	125	0.069	6698570	4610

4611  
VOLTAGE TESTER

- > For 6-24 Volt
- > With cable and alligator crimp



mm 	mm 	mm 		Code	No.
3.0	55	115	0.026	6698650	4611

4612  
VOLTAGE TESTER

- > For 3-48 V
- > Use: automobile, utility vehicles
- > LED displays the voltage in the area of 12, 24, 48 V as well as the polarity
- > For work in confined areas
- > TÜV and GS tested, IEC / EN 61010-1 (DIN VDE 0411)
- > Measurements: 145 x 25 x 16mm
- > Protection classification IP40, protection class III



Measuring range		Code	No.
3-48 V	0.120	1881647	4612

4615

&gt;579



VDE 4616

&gt;579



## Lifters

121-2  
SUCTION CUP LIFTER

with 2 cups

- > With suction mechanism and safety locking
- > In ABS, resistant to oil and acids
- > Fixed suction cups
- > Also suitable for transporting slightly textured surfaces
- > Lifting capacity 60 kg



Ø		Code	No.
120	0.580	2979276	121-2

NEW

121-3  
SUCTION CUP LIFTER

with 3 cups

- > Increased lifting safety with three fixed suction cups
- > Aluminium, enamelled blue
- > Lifting capacity 100 kg

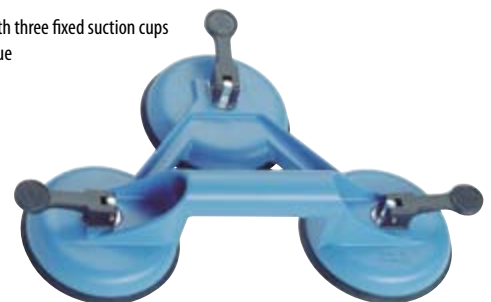

Ø		Code	No.
120	1.403	6390790	121-3

## 121 G SUCTION CUP LIFTER

with 2 cups

- > With suction mechanism and safety locking
- > In ABS, resistant to oil and acids
- > Movable suction cups
- > Particularly suitable for curved panes
- > Lifting capacity 45 kg



↳ mm ↲	∅	⚖	Code	No.
390	120	0.642	6391170	121 G

## 121 G-3 SUCTION CUP LIFTER

with 3 cups

- > Three movable suction cups, resistant to oil and acids, in ABS
- > Particularly suitable for curved panes
- > Cups blue colour, handle black aluminium
- > Lifting capacity 100 kg



∅	⚖	Code	No.
120	1.345	6390870	121 G-3

## 640 MINI MAGNETIC LIFTER

- > Flexible thin shaft for the smallest apertures



↳ mm ↲	Diameter of magnet	∅	⚖	Code	No.
400	3	120	0.024	6530630	640-120
400	4	270	0.025	1785338	640-270



## 640 MAGNETIC LIFTER

- > With flexible shaft and plastic handle
- > Bright nickel-plated



640-500



640-1800

↳ mm ↲	Diameter of magnet	∅	⚖	Code	No.
460	10.0	500	0.095	6531010	640-500
520	12.0	1800	0.230	6531280	640-1800
520	16.5	3000	0.275	6531360	640-3000



## 641 CLAW GRIPPER

- > With flexible shaft for grasping small parts
- > Also suitable for inserting split pins, dowels, etc. in confined areas
- > Max. gripping capacity 14 mm



↳ mm ↲	∅	⚖	Code	No.
540	7	0.103	6531520	641

## 642 SP MAGNETIC LIFTER

with lamp, mirror and clip

- > For searching and lifting small metal parts in confined areas
- > If necessary, the magnet can be removed
- > Mirror diameter 30 mm



↳ mm ↲	Diameter of magnet	∅	⚖	Code	No.
500	12	350	0.172	6536750	642 SP

## Spark Plugs

### D 48 SPARK PLUG SOCKET WRENCH



- > Double ended
- > Forged from solid stock
- > With fully pivoting sheet metal covered lever
- > With sheet clip
- > GEDORE vanadium steel 31CrV3, chrome-plated

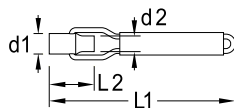

mm	"AF	L <sub>1</sub>	L <sub>2</sub>	d <sub>1</sub>	d <sub>2</sub>	kg	Code	No.
16 x 20,8	5/8 x 13/16	232	56	27.5	21.5	0.233	6360100	D 48

### DS 49 SPARK PLUG SOCKET WRENCH



- > With rubber holder and offset bores
- > Forged and hardened, chrome-plated
- > With angled tommy bar No. 49 D Ø 8 mm
- > In seamless precision tubing as per DIN 2391-ST 55, chrome-plated

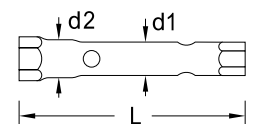

mm	"AF	L	d <sub>1</sub>	d <sub>2</sub>	kg	Code	No.
16 x 20,8	5/8 x 13/16	190	24	25	0.324	6361340	DS 49 R

### 50 - 57 SPARK PLUG SOCKET

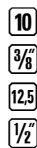

- > With retention spring
- > For use in confined areas, with jointed tools 3/8" or 1/2" square drive or tommy bar Ø 8 mm
- > GEDORE vanadium steel 31CrV3, polished head, chrome-plated

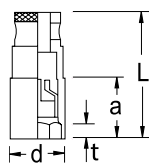

mm	"AF	"	L	t	a	d	kg	Code	No.
20.8	13/16	1/2	63.5	7	25.5	27.5	0.136	6361690	50
20.8	13/16	3/8	63.5	7	25.5	27.5	0.148	6362580	52
16.0		3/8	63.5	7	20.5	21.5	0.103	6362740	53
16.0		1/2	63.5	7	20.5	21.5	0.095	6363040	54
18.0		3/8	63.5	7	20.5	23.5	0.138	6361770	56
18.0		1/2	63.5	7	20.5	23.5	0.125	6361930	57

### 50 MH - 59 MH SPARK PLUG SOCKET

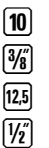

with magnet

- > With two magnets
- > For use in confined spaces with jointed tools 3/8" or 1/2" square drive or tommy bar Ø 8 mm
- > With powerful magnets in the hexagon surface, which hold the spark plug safely on the hexagon
- > Wide opening gives space to the spark plug and makes it easier to put on the socket in confined areas
- > The ceramic core of the spark plug remains untouched
- > GEDORE vanadium steel 31CrV3, chrome-plated, polished head



57 MH



50 MH

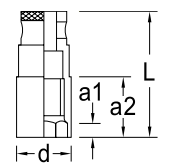

mm	"AF	"	L	a <sub>1</sub>	a <sub>2</sub>	d	kg	Code	No.
20.8	13/16	1/2	64	7	30.5	27.5	0.136	6361420	50 MH
20.8	13/16	3/8	64	7	30.5	27.5	0.146	6361500	52 MH
16.0		3/8	64	7	30.5	21.5	0.100	6363390	53 MH
16.0		1/2	64	7	30.5	21.5	0.094	6363470	54 MH
18.0		3/8	64	7	30.5	23.5	0.137	6361850	56 MH
18.0		1/2	64	7	30.5	23.5	0.127	6362150	57 MH
13.0		3/8	64	7	30.5	18.0	0.074	6366220	59 MH

## SAFETY NOTES



- > For engines with ignition coils integrated in the spark-plug connector (coil-on-plug), use only spark-plug sockets with retainer springs! (Nos. 50 - 57)
- > Do not use magnetic spark-plug spanners on coil-on-plug spark plugs!
- > This can result in control unit faults!

## S 51 GU SET OF SPARK PLUG SOCKETS 3/8"

10 pieces

- > 4 spark plug sockets with magnets, 1 socket with UD profile
- > Reversible ratchet with flexible head and fine tooth mechanism, 3/8" square drive
- > 3 extensions, 1 universal joint
- > GEDORE vanadium steel 31CrV3
- > In GEDORE blue sheet steel case
- > Dimensions: 320 x 210 x 55 mm

Contents		Code	No.
52 MH 53 MH 56 MH 59 MH D 55 3093 GU-3 3090-3 -5 -10 3095	2.523	1795554	S 51 GU



## D 55 SPARK PLUG SOCKET 3/8"

UD profile

- > With retention spring
- > For use with jointed tools 3/8" square drive or tommy bar Ø 8 mm



Ø mm	"	□	L	t	a	d		Code	No.
14	3/8	10	63.5	7.0	22.5	19.2	0.068	1793586	D 55

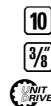

## PR 265 SPARK PLUG SOCKET WRENCH

- > With tommy bar 26 D 8 and 1/2" square drive for use with the torque wrenches
- > Particularly suitable for Renault and Peugeot



Ø mm	Ø "AF	L	d		Code	No.
16.0	5/8	270	20.2	0.250	6646340	PR 265

## 647 SPARK PLUG BRUSH

- > With wooden handle and brass wire bristles



↳ mm	Bristle length		Code	No.
180	15	0.022	6531950	647

## 648 SPARK PLUG BRUSH

- > With plastic handle and brass wire bristles



↳ mm	Bristle length		Code	No.
100	14	0.009	6532090	648

## Exhaust / Engine / Various

## 224 RATCHET PIPE CUTTER NIRO

for stainless steel pipes

- › Low space requirements, therefore highly suitable for working on vehicle exhaust gas systems
- › Body in zinc-plated pressure-cast aluminium
- › Easy handling via ratchet feed with automatic infeed of the cutting wheel with every rotation
- › Cutting wheel made from high-alloy stainless steel, with high service life
- › One spare cutting wheel in addition



Ø mm	Wall thickness	l mm	kg	Code	No.
16-35	1,0-3,0	260	0.930	1600877	224011
25-66	1,0-3,0	360	1.710	1600885	224021

## 4589 CHAIN PIPE CUTTER

- › For pipes with Ø 75 mm and wall thickness 2.6 mm
- › Also suitable for stainless steel pipes
- › Spare chain E 4589 A



Ø mm max.	length appr.	kg	Code	No.
80	246	0.909	1446940	4589
	315	0.200	1446959	E-4589 A

## E 224 SPARE PARTS



224611



224211

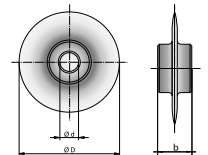

Description	Ø D	b	Ø d	kg	Code	No.
Cutting wheel size 1 + 2	26	6.3	4.8	0.007	1621440	224211
Wheel bolt size 1 + 2				0.003	1621459	224611

## 614 ANTI-FREEZE TESTER

- › For ethylene glycol mixtures
- › Practical, reliable apparatus with high measuring accuracy
- › Easy-to-read scale with degrees Celsius
- › Made from high-quality impact-resistant plastics
- › Corrosion-proof
- › Suction tube length: 185 mm



kg	Code	No.
0.150	6523770	614

## 8134 INSTALLATION PLIERS

- › For spreading of horseshoe pattern circlips of shaft retainers, on motors, gearboxes, clutches, etc.
- › For VW, AUDI and American vehicles
- › GEDORE vanadium steel 31CrV3



l mm	l inch	kg	Code	No.
170	6.3/4	0.191	6722030	8134-170 C

## Car body work

### 269 BODYWORK FILE

- > With light-alloy handle and flexible milled file blades
- > **269 K** complete with 269 F 9
- > **269 L** without milled file blade



Execution		Code	No.
<b>complete</b>	1.050	6460080	269 K
<b>without file blade</b>	0.614	6460160	269 L

### 269 F FLEXIBLE MILLED FILE BLADES



Teeth "	Execution	l mm		Code	No.
<b>7</b>	extra coarse	354	0.249	5460030	269 F 7
<b>9</b>	coarse	354	0.289	5460110	269 F 9
<b>12</b>	fine	354	0.303	5460380	269 F 12

### 252 - 288 PLANISHING HAND ANVILS

- > Made from hardened and tempered steel to EN 10083
- > Enamelled, with ground faces

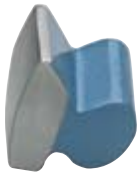

252



253



254



255



259



281



282



285



288

Measurements		Code	No.
<b>72 x 55 x 63</b>	1.206	6456990	252
<b>Ø 58.5 x 60</b>	0.844	6457020	253
<b>80 x 60 x 33</b>	1.070	6457100	254
<b>120 x 58 x 23</b>	0.942	6457290	255
<b>125 x 55 x 25</b>	1.028	6457610	259

Measurements		Code	No.
<b>130 x 55 x 36</b>	0.933	6461720	281
<b>100 x 40 x 80 x 70 x 62</b>	1.372	6461800	282
<b>111 x 68 x 23.5</b>	0.999	6462020	285
<b>104 x 66 x 25</b>	0.987	6463340	288



## 289 - 291 BODYWORK SPOON

- > Made from hardened and tempered steel to EN 10083
- > Enamelled, with ground faces

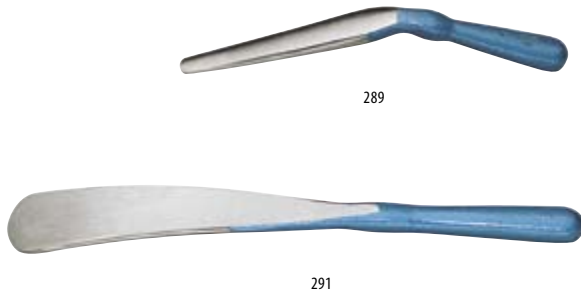

↳ mm ▶	↳ inch ▶	⚖️	Code	No.
275	11	0.545	6463420	289
390	16	1.014	6463690	291

## 292 - 293 BODYWORK LEVER

- > GEDORE vanadium steel 31CrV3
- > Enamelled, with ground faces



↳ mm ▶	↳ inch ▶	⚖️	Code	No.
450	16	1.888	6463770	292
500	19	2.186	6463850	293

## 251 FLAT ROUND FACE HAMMER

- > With ergonomic ash handle (E-251 E)
- > Made from hardened and tempered steel to EN 10083
- > Enamelled blue, with ground faces



### E-251 E SPARE HANDLE ASH

↳ mm ▶	↳ mm ▶	● mm	● mm	Spare handle	⚖️	Code	No.
300	155	40	31	E-251 E	0.497	6456720	251

↳ mm ▶	⚖️	Code	No.
300	0.111	1808621	E-251 E

## 261 PLANISHING HAMMER

- > With ergonomic ash handle (E-261 E)
- > Made from hardened and tempered steel to EN 10083
- > Enamelled blue, with ground faces



### E-261 E SPARE HANDLE ASH

↳ mm ▶	↳ mm ▶	● mm	Spare handle	⚖️	Code	No.
325	160	31	E-261 E	0.512	6457960	261

↳ mm ▶	⚖️	Code	No.
325	0.111	1440934	E-261 E

## 272 - 273 SMOOTHING HAMMER

- > With ergonomic ash handle (E-251 E)
- > Made from hardened and tempered steel to EN 10083
- > Enamelled blue, with ground faces
- > The K models have one milled cross-hatched face and one smooth square face



↳ mm ▶	┆ mm	● mm	■ mm	Spare handle	⚖	Code	No.
300	105	32	25	E-251 E	0.306	6460400	272
300	105	32	25	E-251 E	0.322	6460590	272 K
300	100	40	35	E-251 E	0.403	6460670	273
300	100	40	35	E-251 E	0.395	6460750	273 K

## 275 - 276 EMBOSSING HAMMER

- > With ergonomic ash handle (E-251 E)
- > Made from hardened and tempered steel to EN 10083
- > Enamelled blue, with ground faces



↳ mm ▶	┆ mm	● mm	Spare handle	⚖	Code	No.
300	160	40	E-251 E	0.446	6461050	275
300	160	40	E-251 E	0.446	6461130	276

## 277 POINT PEIN HAMMER

- > With ergonomic ash handle (E-251 E)
- > Made from hardened and tempered steel to EN 10083
- > Enamelled blue, with ground faces



↳ mm ▶	┆ mm	● mm	Spare handle	⚖	Code	No.
300	137	37	E-251 E	0.331	6461210	277

## 278 PLANISHING / GROOVING HAMMER

- > With ergonomic ash handle (E-251 E)
- > Made from hardened and tempered steel to EN 10083
- > Enamelled blue, with ground faces



↳ mm ▶	┆ mm	● mm	Spare handle	⚖	Code	No.
300	160	40	E-251 E	0.406	6461480	278

## Bodywork tool sets

Professional selection of tools

Available loose or in a sturdy steel case, powder-coated blue hammer finish

### 260 BODYWORK TOOL SET

8 pieces

- > Workshop selection
- > Well-chosen workshop assortment for universal use
- > In sheet steel case
- > Dimensions: 525 x 206 x 78 mm



Contents	⚖️	Code	No.
251 252 253 254 255 281 273 K 226 E-2 + WK 260 L	8.9	6457880	260
251 252 253 254 255 281 273 K 226 E-2	6.7	6459150	S 260

### 280 BODYWORK TOOL SET

12 pieces

- > Large workshop assortment
- > Good selection of the most common bodywork tools
- > In sheet steel case
- > Dimensions: 545 x 230 x 110 mm



Contents	⚖️	Code	No.
272 K 273 K 277 278 281 282 288 291 292 293 259 225 E-32 + WK 280 L	15.4	6461640	280
272 K 273 K 277 278 281 282 288 291 292 293 259 225 E-32	11.8	6462290	S 280

## Sheet metal forming tools

### 8532 OFFSETTING PLIERS WITH PUNCH

- > Combination pliers for offsetting sheet metal edges up to 1 mm and for punching sheet metal for spot welding
- > The rotating head makes both operations possible using one tool
- > Single-handed, low-force operation

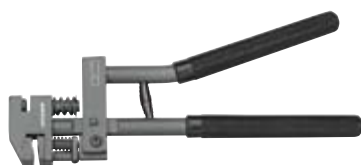

● mm	⌀ mm	└ mm ┘	⚖️	Code	No.
22	5	325	1.258	6751130	8532

### 8533 PUNCH PLIERS

- > With adjustable stop for punching sheet metal up to 1.5 mm



● mm	⌀ mm	└ mm ┘	⚖️	Code	No.
up to 30	5	260	0.955	6751640	8533

# 2200 - 2201 LETTER AND NUMBER PUNCHES

- > To label finished parts such as signs, tools, etc.
- > Made from hardened steel with hardened handle and tempered striking head
- > In blue plastic box
- > No. 2200 = 9 numbers, 6 mm printing height
- > No. 2201 = 27 letters (A - Z, &), 6 mm printing height

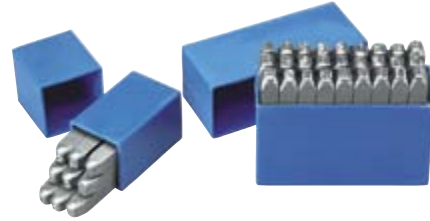

↳ mm ▷	■ mm	⚖ kg	Code	No.
70	9	0.415	8605140	2200-6
70	9	1.240	8605220	2201-6

## Equipment

### 905 CREEPER

- > Comfortable, ergonomically shaped one-piece creeper
- > With practical carrying handle
- > Made from PP (polypropylene) - kind on the skin, resistant to oil, grease and brake fluid
- > Six swivel castors ensure easy and safe manoeuvrability
- > Fatigue-free working, with head/neck cushion for maximum comfort
- > Bucket moulding gives additional hold and allows maximum freedom of movement
- > Two storage trays (right/left) to keep tools and small parts within easy reach
- > Carrying capacity: 130 kg
- > Temperature range -30 °C to +60 °C
- > Dimensions: 1030 x 480 x 115 mm



L	W	H	⚖ kg	Code	No.
1030	480	115	5.0	1823698	905

### 906 KNEELING BOARD

- > Made from solid foam, blue/black
- > With indented grip
- > Dimensions: 450 x 210 x 30 mm



L	W	H	⚖ kg	Code	No.
450	210	30	0.110	1942948	906

### 907 WING PROTECTOR

- > Protection from unwanted scratches, dents and dirt
- > Magnetic attachment keeps paintwork safe from damage - also attaches to galvanised steel sheet
- > Rugged, padded imitation leather and reinforced edges provide a perfect, cushioned working area
- > Dimensions: 1100 x 650 mm with wheel cut-out to allow free access



L	W	⚖ kg	Code	No.
1100	650	0.620	1942956	907

Files

## 8729 CONTACT FILE

> In blue PVC tear-off wallet



↳ "inch	↳ mm	Cut	⚖️	Code	No.
6	150	2	0.009	6771080	8729

## 8701 HAND FILE

> PVC handle  
> DIN 7261, Form A  
> Cut: 2



L	L"	W	H	Cut	⚖️	Code	No.
150	6	16	4	2	0.096	6768020	8701 2-6
200	8	20	5	2	0.183	6768100	8701 2-8
250	10	25	6	2	0.323	6768290	8701 2-10

## 8722 ROUND FILE

> PVC handle  
> DIN 7261, Form F  
> Cut: 2



Ø	Cut	L	L"	⚖️	Code	No.
6.0	2	150	6	0.057	6770000	8722 2-6
7.5	2	200	8	0.112	6770190	8722 2-8
9.5	2	250	10	0.186	6770270	8722 2-10

## 8730 DEBURRER

> A valuable helper for removing burr on a wide range of different materials  
> The small, free-turning deburring knife adjusts to the contour of the workpiece and removes burr

**Consisting of:**

> 676 Driving handle  
> 699 Bit holder  
> E-8730 Deburrer bit 1/4" hex



Description	⚖️	Code	No.
Deburrer	0.090	2190907	8730
Deburrer bit 1/4" hex	0.005	2190915	E-8730

## 8728 KEY FILE SET

6 pieces

> Acc. to DIN 7283  
> In blue plastic wallet

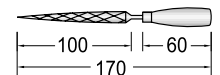

5 types	Cut	⚖️	Code	No.
■ ▲ ● ◐ ■	2	0.150	6771910	8728

## 8719 TRIANGULAR FILE

> PVC handle  
> DIN 7261, Form C  
> Cut: 2  
\* not standardised



L	L"	W	Cut	⚖️	Code	No.
150	6	*	2	0.081	6769260	8719 2-6
200	8	14	2	0.177	6769340	8719 2-8
250	10	17	2	0.304	6769420	8719 2-10

## 8725 HALF-ROUND BLUNT FILE

> PVC handle  
> DIN 7261, Form E  
> Cut: 2



L	L"	W	H	Cut	⚖️	Code	No.
150	6	16	4.5	2	0.091	6770350	8725 2-6
200	8	20	6.0	2	0.170	6770430	8725 2-8
250	10	25	7.0	2	0.285	6770510	8725 2-10

## various

644 - 646  
WIRE BRUSH

- > With untreated wooden handle, angled pattern, smooth, cast steel wire bristles



Execution	Bristle length	↳ mm ↳	⚖️	Code	No.
<b>3-row</b>	23	290	0.137	6531600	644
<b>6-row</b>	25	290	0.156	6531870	646

645  
FILE BRUSH

- > With carded cover and wooden handle
- > Bristle field 110 x 40 mm



↳ mm ↳	Bristle length	⚖️	Code	No.
<b>250</b>	10	0.095	6531790	645

## Saws

401  
SMALL SAW FOR METAL

- > Mini-hacksaw, bright nickel-plated
- > Saw blade 401 A



Description	↳ mm ↳	↳ inch ↳	⚖️	Code	No.
<b>Small saw for metal</b>	350	13.3/4	0.226	6500050	401
<b>Saw blade</b>	200		0.012	5500000	401 A

403  
HACKSAW

- > Adjustable tubular steel frame
- > For 10" and 12" hacksaw blades, complete with No. 403 A-405 A
- > Saw blades single-sided (403 A-405 A) and double-sided (403 B-405 B)
- > Handle enamelled



Description	↳ mm ↳	↳ inch ↳	⚖️	Code	No.
<b>Hacksaw</b>	410	18.1/2	0.411	6500210	403
<b>Saw blade, single-sided</b>			0.028	5500350	403 A-405 A
<b>Saw blade, double-sided</b>			0.041	5500430	403 B-405 B

404  
SMALL SAW FOR METAL PUK

- > Bright nickel-plated
- > Saw blade 404 A-406 A



Description	↳ mm ↳	↳ inch ↳	⚖️	Code	No.
<b>Small saw for metal PUK</b>	290	11	0.107	6500480	404
<b>Saw blade</b>	145		0.003	5501080	404 A-406 A

406  
HOBBY SAW

- > For wood and metal
- > Made from flat bar, 10 x 5 mm, zinc-plated
- > Glass-fibre reinforced plastic handle
- > Reach 50 mm
- > For use with junior hacksaw blades 145 mm
- > Saw blade 404 A-406 A



Description	↳ mm ↳	↳ inch ↳	⚖️	Code	No.
<b>Hobby saw</b>	250	10	0.168	6501020	406
<b>Saw blade</b>	145		0.003	5501080	404 A-406 A

407  
HACKSAW

- > Very light hacksaw in pressure-cast aluminium
- > Ergonomic soft rubber hand grips
- > Fixing of the sawblade by simple turning the blue clamping element in the hand grip
- > Clamping piece adjustable by 40°
- > Saw blade bimetal 407 A



Description	⚖️	Code	No.
<b>Hacksaw</b>	0.650	1879375	407
<b>Saw blade bimetal</b>	0.055	1879383	407 A

V 406

&gt; 595



## Parallel Vices

### 409 - 410 PARALLEL VICE

- > Welded, compact design
- > Jaws and anvil plate induction hardened
- > Extra large anvil surface for aligning works
- > Protected vice spindle
- > Adjustable guidance
- > Enamelled blue



mm	mm	kg	Code	No.
100	120	7.0	6500800	409
150	155	16.4	6500990	410

### 411 PARALLEL VICE

- > Sturdy forged design
- > Jaws and anvil plate induction hardened
- > Protected vice spindle
- > Adjustable guidance
- > Enamelled blue



mm	mm	kg	Code	No.
125	150	12.5	6501100	411-125
150	200	18.5	6501290	411-150

### E-411 SPARE JAWS FOR PARALLEL VICE

- > Jaws induction hardened



Description	mm	kg	Code	No.
Aluminium jaws 125 mm	125	0.186	5704430	E-411 A-125
Aluminium jaws 150 mm	150	0.218	5704510	E-411 A-150
Pipe-clamping jaws 125 mm	125	0.794	5704270	E-411 R-125
Pipe-clamping jaws 150 mm	150	0.778	5704350	E-411 R-150

## Measuring Tools

### 702 FEELER GAUGE SET, FAN PATTERN

- > With protective handle, folding, blade length 100 mm
- > Handle nickel-plated
- > 702 22 A + 702 26 A each increasing by 1/1000"



	kg	Code	No.
5 10 15 20 25 30 40 50/100	0.037	6547520	702 8 M
3 4 5 6 7 8 9 10/100	0.027	6547600	702 88 M
5 10 15 20 25 30 40 50 60 70 80 90 100/100	0.065	6547790	702 13 M
5 10 15 20 25 30 35 40 45 50 55	0.100	6547870	702 20 M
60 65 70 75 80 85 90 95 100/100			
10 12 14 16 18 20 22 24 26 28 30	0.068	6547950	702 21 M
32 34 36 38 40 42 44 46 48 50/100			

	kg	Code	No.
.002 .004 .006 .008 .010 .012 .015 .020"	0.033	6548250	702 8 A
.0015 .002 .003 .004 .006 .008 .010 .012 .015 .020 .025"	0.038	6548410	702 11 A
.002 .003 .004 .005 .006 .008 .010 .012 .015 .020 .025 .030 .035"	0.055	6548680	702 13 A
.004 - .025"	0.081	6548760	702 22 A
.0015 - .025"	0.080	6548840	702 26 A

## 703 M VALVE FEELER GAUGE

- > 7 Blades, blade length 75 mm



			Code	No.
10 15 20 25 30 35 40/100	0.011		6549140	703 M

## 705 M SPARK PLUG GAUGE

- > With electrode adjuster
- > Gauge wires in precision steel wire



			Code	No.
40 50 60 70 75 80 90 100/100 mm	0.027		6549570	705 M

## 706 THREAD GAUGE

- > 52 Blades
- > For metric and Whitworth threads
- > Pitches 0.25-6.00 mm / 62-4 Step" W



Pitch		Code	No.
0,25-6,00	0.083	6549730	706

## 710 POCKET VERNIER CALLIPER

- > DIN 862, Form A 2
- > For internal and external measurements, with polished tips, depth gauge and high-speed setting
- > Graduated in mm and inches, vernier 1/20 and 1/128"
- > In leather wallet



				Code	No.
213	140	5.1/2	0.171	6555030	710

## 711 DIGITAL MEASURING CALLIPER

- > To DIN 862
- > Stainless steel, hardened
- > Switchable from mm to inch
- > Measuring range 0 - 150 mm/6"
- > Data output (mini-USB)
- > Zeroing in any position
- > Measurement beak finely smoothed and lapped
- > Large LCD display (digit height 9 mm)
- > Can be used with or without thumb roller (replacement part without thumb roller included in delivery for self-mounting)
- > In sturdy protective case

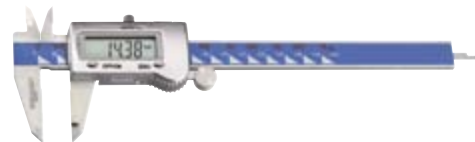

				Code	No.
230	153	6	0.408	6550070	711

## 717 STEEL RULE

- > Steel rule with millimetre and inch graduation acc. to DIN ISO 2768
- > Top edge 1/64; 1/32 and 1/16 inch graduation, bottom edge 1/2 mm and 1/1 mm graduation
- > Etched graduation for a legible reading
- > Reading from left to right
- > Flexible version
- > Stainless spring-steel
- > Satin non-glare finish
- > Dimensions: 300 x 18 x 0.5 mm



			Code	No.
300	12	0.010	1965603	717-30

## 718 INSPECTION MIRROR

- > For inspection of areas that are not directly visible
- > Mirror of resistant mineral glass, Ø 30 mm, swivels through 360°
- > Telescope handle adjusts from 130 to 670 mm
- > Brass handle, mirror frame from stainless steel
- > Nickel-plated
- > Resistant to oil, grease and brake fluid



Ø			Code	No.
30	130-670	0.040	1979841	718



## 720 TWEEZERS

- > With angled tips
- > Bright nickel-plated



l mm	kg	Code	No.
150	0.025	6556270	720

## 721 CROSS TWEEZERS

- > With straight tips
- > Bright nickel-plated



l mm	kg	Code	No.
160	0.033	6556350	721

## 722-1 PRECISION TWEEZERS

- > Flat, fine, long points
- > Satin non-glare finish



l mm	kg	Code	No.
130	0.022	1881655	722-1

## 722-1 ESD PRECISION TWEEZERS ESD

- > Flat, fine, long points
- > Satin non-glare finish
- > ESD = electrostatic discharge protection, black



l mm	kg	Code	No.
130	0.022	1881663	722-1 ESD

## 722-2 PRECISION TWEEZERS

- > Flat, fine points
- > Satin non-glare finish



l mm	kg	Code	No.
95	0.010	1881671	722-2

## 745 SCRIBER

- > Made from special steel



l mm	kg	Code	No.
250	0.058	6559530	745

## 746 CARBIDE SCRIBER

- > Carbide, silver
- > With drop mechanics
- > Replaceable tip (E-746)



l mm	kg	Code	No.
140	0.022	6559610	746

## 4533-2 FOLDING RULE

- > Robust 2 m model with brass protective caps
- > Most suitable for craftsmen or do-it-yourselfers
- > Links 3.0 x 16 mm
- > Made of branch free beechwood with invisible metal fittings
- > Riveted joint guarantees correct measurement even in humid or dry conditions
- > With easy to read metric dual scale
- > Accuracy class III
- > EG-design approval for continuous mm division



## 4534 STEEL TAPE MEASURE

- > With belt clip and rewind stop
- > mm-divisions
- > Approved standard mark

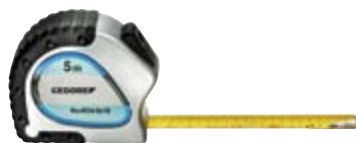

L m	mm	kg	Code	No.
3	13	0.128	6697920	4534-3
5	19	0.220	6698060	4534-5
8	25	0.365	6698140	4534-8

L m	kg	Code	No.
2	0.086	1837087	4533-2

## Thread Workings

# 8552-025 SCREW EXTRACTOR SET

25 pieces

- > For extracting broken screws and bolts with threads M5 - M16
- > In handy plastic case, with twist drills, guide sleeves, extractor pins and extractor nuts
- > Dimensions: 200 x 120 x 38 mm



Contents		Code	No.
<b>Extractor pins size 1 2 3 4 5</b>	0.790	6755550	8552-025
<b>Drilling sleeves 1 2 3 4 5 6 7 8 9 10</b>			
<b>Extractor nuts size 10 11 13 14 17</b>			
<b>Drills 8.7-11/32" 8-5/16" 6.4-1/4" 4.8-3/16" 3.2-1/8"</b>			

# 140 THREAD FILE

- > For repairing damaged internal and external threads
- > Chrome-vanadium steel, ISO-nickel-plated
- > 140 metric threads
- > 140 A inch threads
- > 140 W Whitworth threads



for thread pitches			Code	No.
<b>0.80 1.00 1.25 1.50 2.00 2.50 3.00 mm</b>	230	0.125	6409640	140
<b>24 20 18 16 14 13 12 11 inch</b>	230	0.125	6409720	140 A
<b>24 20 18 16 14 12 11 10 Whitworth</b>	230	0.124	6409800	140 W

# 8551 S SCREW EXTRACTOR

- > For removing broken screws, bolts and tube ends
- > Made from high-grade chrome-vanadium steel, tempered, 54-56 HRC
- > Lower unscrewing torques thanks to the revised cross-section geometry
- > Reduced drilling depth thanks to an optimised thread length
- > Greater safety for user and component alike
- > Larger application range, time-saving



		Ø	Bore mm			Code	No.
<b>M3 - M6</b>	1/8-1/4	1,8-7,0	1,8	2,7	50	0.003 2659352	8551 S 1
<b>M6 - M8</b>	1/4-5/16	3,2-10,0	3,2	3,8	57	0.007 2659379	8551 S 2
<b>M8 - M11</b>	5/16-7/16	4,5-13,0	4,5	4,9	64	0.014 2659387	8551 S 3
<b>M11 - M14</b>	7/16-9/16	6,5-16,0	6,5	7,0	71	0.027 2659395	8551 S 4
<b>M14 - M18</b>	9/16-3/4	8,5-21,0	8,5	9,0	79	0.046 2659409	8551 S 5
<b>M18 - M24</b>	3/4-1	12,0	12,0	12,0	85	0.095 2659417	8551 S 6

# 8551 S BOLT EXTRACTOR SET

- > For removing broken screws, bolts and tube ends
- > Made from high-grade chrome-vanadium steel, tempered, 54-56 HRC



8551 S-006



8551 S-005

Contents			Code	No.
<b>8551 S 1 2 3 4 5</b>	M3-M18	0.125	2659336	8551 S-005
<b>8551 S 1 2 3 4 5 6</b>	M3-M24	0.230	2659344	8551 S-006

# 8551 BOLT EXTRACTOR SET

- > Made from chrome-vanadium steel, 54 HRC
- > In transparent plastic box



8551-55

Contents			Code	No.
<b>8551 1 2 3 4 5</b>	M3-M18	0.117	6759620	8551-55
<b>8551 1 2 3 4 5 6</b>	M3-M24	0.221	6759700	8551-66
<b>8551 1 2 3 4 5 6 7 8</b>	M3-M45	0.724	6759890	8551-88

## 8551 BOLT EXTRACTOR

> Made from chrome-vanadium steel, 54 HRC

### Operation:

- > Drill a central hole into the broken bolt (see table)
- > Turn the bolt extractor to the left into this hole until it grips and removes the bolt (penetrating oil may be necessary!)
- > Always choose the largest possible extractor size



$\frac{M}{mm}$	$\frac{M}{mm}$	$\emptyset$	Bore mm	$\leftarrow mm \rightarrow$	$\frac{kg}{mm^2}$	Code	No.
<b>M3 - M6</b>	1/8-1/4	1,4-3,6	1,8	2,7	50	0.005 6758490	8551 1
<b>M6 - M8</b>	1/4-5/16	2,1-4,9	2,6	3,8	57	0.009 6758570	8551 2
<b>M8 - M11</b>	5/16-7/16	3,1-5,5	3,7	4,9	65	0.015 6758650	8551 3
<b>M11 - M14</b>	7/16-9/16	4,8-8,8	5,5	7,0	70	0.030 6758730	8551 4
<b>M14 - M18</b>	9/16-3/4	6,2-11,0	7,0	9,0	80	0.051 6758810	8551 5
<b>M18 - M24</b>	3/4-1	9,4-15,0	10,3	12,0	85	0.098 6759030	8551 6
<b>M24 - M33</b>	1-1.3/8	12,7-19,0	13,7	14,5	95	0.162 6759110	8551 7
<b>M33 - M45</b>	1.3/8-1.3/4	17,5-24,0	18,6	18,0	100	0.283 6759380	8551 8

## 8551 TG TAP WRENCH WITH RATCHET

> To operate bolt extractors (no. 8551 and 8551 S) in confined spaces

- > Reversible for clockwise or counterclockwise operation
- > Sliding T-handle
- > With two-jaw chuck to hold square shanks
- > All steel version, chrome-plated

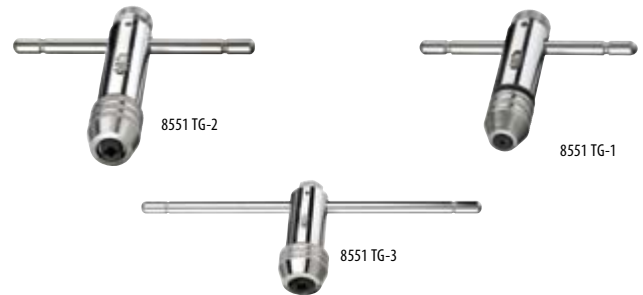

mm	$\frac{M}{mm}$	$\leftarrow mm \rightarrow$	$\frac{kg}{mm^2}$	Code	No.
<b>2,0-5,0</b>	M3-M8	85	0.186	2659433	8551 TG-1
<b>4,6-8,0</b>	M5-M12	110	0.315	2659441	8551 TG-2
<b>9,0-12,5</b>	M13-M20	117	1.040	2659468	8551 TG-3

## 8553 TAP AND DIE SET

- > In plastic case
- > Dimensions: 275 x 150 x 42 mm
- > For internal threads M3 - M6
- > For external threads M3 - M6, max. 40 mm long
- > Ratchet drive system with extension unit
- > Additional guide sleeve for dies to ensure accurately aligned thread cutting along the bar axis, with swarf collector
- > **Drives:** Ratchet with extension
- > **Taps:** Quick-clamp tap wrench with M3-M6 taps
- > **Dies:** Die handle with guide disc and M3-M6 dies
- > **Accessories:** Fixing screws and angle screwdriver



Contents	$\frac{kg}{mm^2}$	Code	No.
T-handle ratchet 2093 U-3 T	0.510	1939068	8553
Hex socket key 2 mm			
Extension, 1/4" 4 mm			
Die holder			
Quick-clamp tap wrench			
Threaded stud M4x6			
Backing washer			
Guide disc M3 M4 M5 M6			
Dies M3 M4 M5 M6			
Taps M3 M4 M5 M6			

## Scrapers

### 130 THREE-EDGED BEARING SCRAPER

- > Made from special steel
- > Working ends polished
- > With wooden handle
- > Flanged blade



Spoon				Code	No.
70	150	270	0.136	8777350	130-150
85	200	315	0.171	8777430	130-200

### 132 THREE-EDGED HOLLOW GROUND SCRAPER

- > Made from special steel
- > Working ends polished
- > With wooden handle
- > Flanged blade



			Code	No.
150	270	0.100	8779130	132-150
200	315	0.163	8779480	132-200
250	365	0.185	8779560	132-250

## SAFETY INSTRUCTION FOR SCRAPERS



- > Do not touch the sharp working edges.

### 133 D GASKET SCRAPER

- > Made from special steel
- > With wooden handle
- > Flanged blade



			Code	No.
150	260	0.120	1395262	133 D-150

### 134 THREE-EDGED FLAT GROUND SCRAPER

- > Made from special steel
- > Working ends polished
- > With wooden handle
- > Flanged blade



			Code	No.
100	200	0.072	8781620	134-100
150	270	0.139	8781890	134-150
200	315	0.168	8782000	134-200

### 131 CURVED BEARING SCRAPER (LONG SCRAPER)

American pattern

- > Made from special steel
- > Working ends polished
- > With wooden handle

- > Flanged blade



Spoon				Code	No.
85	200	315	0.100	8778320	131-200

### 133 F FLAT SCRAPER

- > Made from special steel
- > Working ends polished
- > With wooden handle

- > Flanged blade
- > \* not standardised



					Code	No.
150	270	20	5	*	0.190	8780490 133 F-150
200	315	20	5		0.234	8780650 133 F-200
250	365	25	6		0.390	8780730 133 F-250

### 133 H HARD METAL TIP FLAT SCRAPER

- > Soldered hard metal tip
- > Wooden handle



					Code	No.
30	5	250	365	0.350	4523000	133 H

### 133 K GASKET SCRAPER

- > With plastic handle



				Code	No.
10	240	22.5	0.154	6535190	133 K

### 134 K THREE-SQUARE SCRAPER

- > With ground edges
- > Shaft PVC coated
- > Black plastic handle



				Code	No.
6	80	170	0.060	4646860	134 K

## Arc punches

5700  
ARC PUNCH

- > To DIN 7200 Form A
- > For stamping out cardboard, leather, rubber, sealing materials and other soft materials
- > Cutting edge hardened
- > Shaft blue varnished

Ø mm	Ø inch	l mm	W kg	Code	No.
2	1/16	105	0.045	4542300	570002
3	1/8	105	0.045	4542490	570003
4	5/32	105	0.050	4542570	570004
5	3/16	110	0.070	4542650	570005
6	1/4	110	0.070	4542730	570006
7		120	0.090	4542810	570007
8	5/16	120	0.090	4543030	570008
9	11/32	120	0.090	4543110	570009
10	3/8	130	0.125	4543380	570010
11	7/16	130	0.130	4543460	570011
12	15/32	130	0.130	4543540	570012
13	1/2	140	0.165	4543620	570013
14	9/16	140	0.170	4626590	570014
15	19/32	140	0.180	4543890	570015
16	5/8	140	0.180	4543970	570016
17	21/32	145	0.230	4544000	570017
18	11/16	145	0.230	4544190	570018
19	3/4	145	0.240	4544270	570019
20	25/32	160	0.315	4544350	570020
21	13/16	160	0.315	4546560	570021

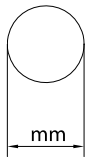

Ø mm	Ø inch	l mm	W kg	Code	No.
22	7/8	160	0.320	4545670	570022
23	29/32	170	0.375	4545750	570023
24	15/16	170	0.375	4540440	570024
25	1	170	0.400	4618300	570025
26	1.1/32	170	0.375	4618490	570026
27	1.1/16	175	0.475	4618570	570027
28	1.3/32	175	0.500	4618650	570028
29	1.1/8	175	0.450	4618730	570029
30	1.3/16	190	0.590	4618810	570030
31		190	0.580	4619030	570031
32	1.1/4	190	0.580	4619110	570032
33		195	0.660	4619380	570033
34	1.5/16	195	0.675	4619460	570034
35	1.3/8	195	0.690	4619540	570035
36		200	0.700	4619620	570036
37	1.7/16	205	0.700	4619700	570037
38	1.1/2	205	0.770	4619890	570038
39		205	0.770	4619970	570039
40	1.9/16	205	0.860	4620040	570040

5703  
SET OF ARC PUNCHES

- > To DIN 7200 Form A
- > For stamping out cardboard, leather, rubber, sealing materials and other soft materials
- > Cutting edge hardened
- > Shaft blue varnished
- > In plastic wallet no. 570390



Contents	W kg	Code	No.
<b>10 pieces, consisting of 1 piece each</b> <b>Arc punch 3, 5, 7, 8, 10, 13, 16, 19, 22 and 25 mm</b>	1.850	1549502	570303
<b>8 pieces, consisting of 1 piece each</b> <b>Arc punch 3, 6, 8, 10, 12, 16, 20 and 25 mm</b>	1.470	1549510	570304
<b>7 pieces, consisting of 1 piece each</b> <b>4, 6, 8, 10, 12, 14, 16 mm</b>	0.960	2646382	570307

1101-5705  
SET OF ARC PUNCHES

in i-BOXX® 72

- > To DIN 7200 Form A
- > For stamping out cardboard, leather, rubber, sealing materials and other soft materials
- > Cutting edge hardened
- > Shaft blue varnished
- > Delivery in GEDORE i-BOXX® 72 no. 1101 L
- > Dimensions: W 367 x D 316 x H 72 mm



Contents	W kg	Code	No.
<b>18 pieces, consisting of 1 piece each</b> <b>Arc punch 2, 3, 4, 5, 6, 7, 8, 9,</b> <b>10, 11, 12, 13, 14, 15, 16, 18, 20, 22 mm</b> <b>1 GEDORE i-BOXX® 72 no. 1101 L</b>	3.395	2963469	1101-570500

## Tin snips

### 420 TIN SNIPS

- > Right hand cutting
- > For long straight cuts
- > Berlin pattern
- > Ground cutting edges
- > Sheet thickness max. 1.0 mm at strength 600 N/mm<sup>2</sup>
- > Black varnished, handles blue epoxy coated



Execution	l mm	kg	Code	No.
right hand cutting	250	0.470	4513980	420025
right hand cutting	300	0.740	4514010	420030

### 421 HOLE CUTTING SNIPS

- > For short straight and figure cuts (great radii)
- > Polished cutting edges
- > Sheet thickness max. 1.0 mm at strength 600 N/mm<sup>2</sup>
- > Black varnished, handles blue epoxy coated



Execution	l mm	kg	Code	No.
right hand cutting	250	0.490	4514280	421025
right hand cutting	275	0.520	4514360	421027

### 422 IDEAL PATTERN SNIPS

- > For straight continuous and figure cuts
- > Polished cutting edges
- > Sheet thickness max. 1.0 mm at strength 600 N/mm<sup>2</sup>
- > Black varnished, handles blue epoxy coated



Execution	l mm	kg	Code	No.
right hand cutting	260	0.510	4514870	422026
left hand cutting	260	0.565	4515090	422126

### 423 PELICAN PATTERN SNIPS

- > Right hand cutting
- > For long straight continuous and figure cuts
- > Polished cutting edges
- > Sheet thickness max. 1.0 mm at strength 600 N/mm<sup>2</sup>
- > Black varnished, handles blue epoxy coated



Execution	l mm	kg	Code	No.
right hand cutting	300	0.730	4515250	423030
right hand cutting	350	0.850	4515330	423035

### 424 IDEAL PATTERN SNIPS

- > For straight continuous and figure cuts
- > With lever action
- > Self-opening with installed spring, with lock
- > Polished cutting edges
- > Sheet thickness max. 1.2 mm at strength 600 N/mm<sup>2</sup>
- > Non-slip 2-component handles



Execution	l mm	kg	Code	No.
right hand cutting	260	0.530	4515410	424026
left hand cutting	260	0.530	4515680	424126

### 425 FIGURE SNIPS

- > For straight continuous and figure cuts
- > With lever action
- > Self-opening with installed spring, with lock
- > Polished cutting edges
- > Sheet thickness max. 1.2 mm at strength 600 N/mm<sup>2</sup>
- > Non-slip 2-component handles



Execution	l mm	kg	Code	No.
right hand cutting	260	0.480	4515760	425026

## Industrial Cutlery

- > Cutlery is traditionally not made from tempering steel, but from plain carbon steel. Carbon steel is not stainless, but keeps its sharpness longer than stainless steel.
- > All GEDORE scissors are hot, drop-forged.
- > Precisely machined and hardened/tempered.



- > The cutting-edge is manually ground
- > Carbon steel, professional hardening/tempering and the hand-ground cutting edge ensure an optimum cut and cutting-sharpness longevity.

## Knives

### 0038 POCKET KNIFE

- > Anchor or dinghy knife for heavy-duty use
- > Folding
- > Universal use
- > Extremely sharp
- > C75 carbon steel blade
- > Weatherproof hardwood handle





			Code	No.
80	180	0.086	9100580	0038-08

### 0042 CABLE KNIFE

- > With wire stripper
- > Folding
- > Universal use
- > Extremely sharp
- > C75 carbon steel blade
- > Weatherproof hardwood handle





			Code	No.
90	195	0.076	9100660	0042-09

### 0063 CABLE KNIFE

- > With wire stripper
- > Folding
- > Universal use
- > Extremely sharp
- > X46Cr13 stainless steel blade
- > Plastic handle





			Code	No.
80	200	0.092	9101200	0063-08

### 0059 - 0067 POCKET KNIFE

- > Traditional working knife
- > Folding
- > Universal use
- > Extremely sharp
- > C75 carbon steel blade
- > Weatherproof hardwood handle





			Code	No.
70	160	0.061	9101470	0067-07
90	185	0.078	9101390	0065-09
100	210	0.102	9101120	0059-10

### 0117 WORK KNIFE

- > Ideal as a packaging, boxing, warehousing or paper knife
- > Extremely sharp
- > C75 carbon steel blade
- > Beech handle





			Code	No.
100	220	0.070	9102520	0117-10
120	240	0.080	9102600	0117-12
160	280	0.106	9102790	0117-16
180	300	0.110	9102870	0117-18

### 0246 INDUSTRIAL KNIFE

- > Wide blade with straight back
- > Extremely sharp
- > C75 carbon steel blade
- > Beech handle



			Code	No.
160	280	0.098	9106860	0246-16

## 0291 UNIVERSAL KNIFE

- > Universal use
- > Extremely sharp
- > C75 carbon steel blade
- > Beech handle



Icon	Icon	Icon	Code	No.
			9107910	0291-06
60	175	0.037		

## 0365 UNIVERSAL KNIFE

- > Stainless steel
- > Handle made from cherrywood



Icon	Icon	Icon	Code	No.
			9109290	0365-07
70	165	0.039		

## 0513 CABLE KNIFE

- > With wire stripper
- > Folding
- > Universal use
- > Extremely sharp
- > C70 carbon steel blade
- > Weatherproof hardwood handle



Icon	Icon	Icon	Code	No.
			9113050	0513-09
90	195	0.080		

4528

> 595



VDE 4522 K

> 594



VDE 4527 K

> 594



## Scrapers

### 0175 SCRAPER

- > Stamped blade
- > Fine-polished, flexible C75 carbon steel
- > Glazed beech handle



W	Icon	Code	No.
50		9104060	0175-05
60		9104140	0175-06
100		9104300	0175-10

### 0179 SCRAPER

- > Professional version
- > Fully forged
- > Fine-polished, flexible C50 carbon steel
- > Weatherproof hardwood handle

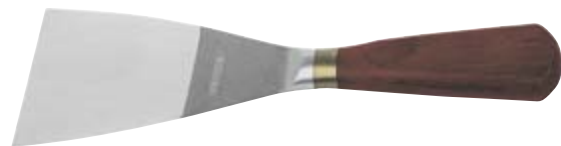

W	Icon	Code	No.
60		9104730	0179-06



## Scissors

## 1104 CRAFTSMAN SCISSORS

- > Outstanding cutting performance
- > Suitable for textiles, rubber, wallpaper, plastic, etc.
- > Forged, resharpenable
- > Adjuster screw for later adjustment
- > Fine-polished C45 carbon steel, varnished eyes, silicone dipped RAL 5015
- > Chrome-plated
- > Version L = for left-handers



Size	Length of cutting edge	Total length		Code	No.
7"	85	180	0.142	9118280	1104-18
8"	95	200	0.248	9118360	1104-20
9"	110	230	0.300	9118440	1104-23
10"	120	260	0.378	9118520	1104-26

## 1277 INDUSTRIAL SCISSORS PROFESSIONAL

- > With two equal eyes
- > For universal use
- > Hand-ground
- > Adjuster screw for later adjustment
- > Fine-polished C45 carbon steel
- > Chrome-plated



Size	Length of cutting edge	Total length		Code	No.
6"	65	160	0.061	9119840	1277-16
7"	80	180	0.088	9119920	1277-18

## 1350 INDUSTRIAL SCISSORS PROFESSIONAL

- > One large and one small eye for higher transmission of force
- > For universal use
- > Hand-ground
- > Adjuster screw for later adjustment
- > Fine-polished carbon steel
- > Chrome-plated
- > Version L = for left-handers



Size	Length of cutting edge	Total length		Code	No.
6"	65	160	0.070	9120770	1350-16
7"	80	180	0.094	9120850	1350-18
7"	80	180	0.094	2082314	1350-18L
8"	100	200	0.132	9120930	1350-20

## 8096 SMALL UNIVERSAL SCISSORS

- > With insulation stripping slot
- > Nickel-plated, with blue handle protectors

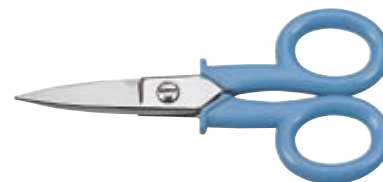

Length of cutting edge	Total length		Code	No.
50	140	0.075	6707900	8096-140

## Safety at work

### Work gloves

#### 920 WORK GLOVES FASTFIT

- > For universal use
- > Close fitting for retention of feel and dexterity
- > Stage 5 classification as per EN 420/03 (scale from 0 - 5)
- > Kind on the skin
- > Rugged imitation leather and synthetic material



Size		Code	No.
<b>S/8</b>	0.070	1938576	920 8
<b>M/9</b>	0.070	1938584	920 9
<b>L/10</b>	0.080	1938592	920 10
<b>XL/11</b>	0.080	1938606	920 11
<b>XXL/12</b>	0.080	1938614	920 12

#### 922 WORK GLOVES M-PACT

- > For heavy duty use
- > Close fitting for retention of feel and dexterity
- > Stage 5 classification as per EN 420/03 (scale from 0 - 5)
- > Rubber reinforced finger tips
- > Adjustable Velcro fasteners on the cuffs
- > Additional knuckle protectors
- > Ergonomic palm reinforcement
- > Rugged imitation leather and synthetic material



Size		Code	No.
<b>S/8</b>	0.080	1938738	922 8
<b>M/9</b>	0.080	1938746	922 9
<b>L/10</b>	0.080	1938754	922 10
<b>XL/11</b>	0.090	1938762	922 11
<b>XXL/12</b>	0.090	1938770	922 12

### Tool Bags

#### WT 1056 1 HEAVY-DUTY BELT WITH CUSHION

- > Fits waist size from 80-120 cm (32"-48")
- > Strongly cushioned for maximum comfort
- > Made from leather



L	W	max. load capacity kg		Code	No.
<b>1330</b>	145	12	0.450	1802410	WT 1056 1

#### WT 1056 2 UNIVERSAL POUCH

- > Leather pocket for knives
- > Hammer holder with metal hooks
- > Hook for tape measure



W	H	max. load capacity kg		Code	No.
<b>290</b>	290	5	0.340	1811096	WT 1056 2

#### WT 1056 3 DRILL HOLSTER

- > Suitable for drill-machines and battery-drills
- > With pockets for screws and bits
- > Securing loop as loss-proof



W	H	max. load capacity kg		Code	No.
<b>210</b>	320	4	0.150	1818147	WT 1056 3

#### WT 1056 4 HAMMER HOLDER WITH METAL HOOKS

- > Holds any claw hammer at a comfortable angle
- > Enables boundless freedom of movement
- > Polyester and blue suede
- > Stainless tab



W	H	max. load capacity kg		Code	No.
<b>100</b>	160	3	0.100	1818155	WT 1056 4

## WT 1056 5 THREE-POUCH BELT SET

- > Fits waist size from 80-120 cm (32"-48")
- > 4 holsters, 5 storage pockets and 1 eyelet for tape measure



W	H	max. load capacity kg		Code	No.
690	270	10	0.750	1818163	WT 1056 5

## WT 1056 6 ELECTRICIANS' POUCH

- > Generous pouch space
- > 8 pockets for screwdrivers
- > Extra pocket for insulation stripping knife
- > Holding shackle for insulating tape





W	H	max. load capacity kg		Code	No.
240	320	3	0.500	1818171	WT 1056 6

## WT 1056 7 HEAVY-DUTY BELT SET

- > Heavily padded belt for superior comfort when fully loaded
- > Fits waist size from 80-120 cm (32"-48")
- > Basic belt from leather
- > All inclusive: Holster, hammer holder, 2 pockets and mobile phone holder (available separately WT 1056 7-1)



Description		max. load capacity kg		Code	No.
<b>Heavy-duty belt set</b>	1330	12	1.600	1818198	WT 1056 7
<b>Mobile phone holder</b>	-	-	0.052	1963171	WT 1056 7-1

## WT 1056 8 DUO POUCH

- > Leather pocket for knives
- > 2 large storage pockets



W	H	max. load capacity kg		Code	No.
240	280	3	0.360	1818201	WT 1056 8

## WT 1056 9 ROLL-COVER

- > With 12 inside pockets for slim tools, e.g. combination spanners or screwdrivers
- > Delivery without tools



W	H	max. load capacity kg		Code	No.
320	350	2	0.120	1818228	WT 1056 9

## WT 1056 10 KNEE PADS, PAIR

- > Made of strong synthetic leather with rubber
- > Soft lining for comfortable kneeling
- > Hook and loop fastener
- > Universal size



kg	Code	No.
0.200	1818236	WT 1056 10

## WT 1056 11 TOOL RUCKSACK PROFI

- > With extra large capacities
- > Practical and ergonomic arrangement of the internal and external pockets
- > Ideal for transport and storage of tools, accessories and documents
- > Strong zippers
- > Reinforced back, padded adjustable shoulder straps and additional practical handle on the top
- > Tear-resistant polyester fabric with 3M reflective stripes, suede
- > Spray-water repellent, resistant to chemical agents
- > Inured to temperature changes



W	H	D	max. load capacity kg	kg	Code	No.
300	400	120	15	2.800	1818244	WT 1056 11

## WT 1056 12 TOOL RUCKSACK SOFT

- > SOFT rucksack, extremely light and yet strong
- > Tear-resistant polyester fabric and suede
- > Strong and watertight
- > Practical and ergonomic arrangement of the internal and external pockets
- > Ideal for transport and storage of tools, accessories and documents
- > Strong zippers
- > Padded adjustable shoulder straps and additional practical handle on the top



W	H	D	max. load capacity kg	kg	Code	No.
380	410	70	12	1.900	1818252	WT 1056 12

## WT 1056 13 TOOL VEST

- > Multifunctional tool vest with many pockets and holsters
- > Universal size with 4 lateral buckles
- > Padded pouches of different dimensions for tools and small components
- > Mobile phone holder and reinforced tab to hang a hammer
- > Wide back pouch
- > Net insert in the back for a better transpiration
- > Compartment with window for an identity card
- > Tear-resistant polyester fabric with 3M reflective stripes, suede
- > Spray-water repellent, resistant to chemical agents
- > Inured to temperature changes



W	H	max. load capacity kg	kg	Code	No.
480	660	5	1.000	1818260	WT 1056 13