

THESE DRAWINGS ARE THE PROPERTY OF QUALTEK ELECTRONICS AND NOT TO BE REPRODUCED FOR OR COMMUNICATED TO A THIRD PARTY WITHOUT THE EXPRESS WRITTEN PERMISSION OF AN OFFICER OF QUALTEK ELECTRONICS.

REVISION			
REV.	DESCRIPTION	DATE	APPROVED

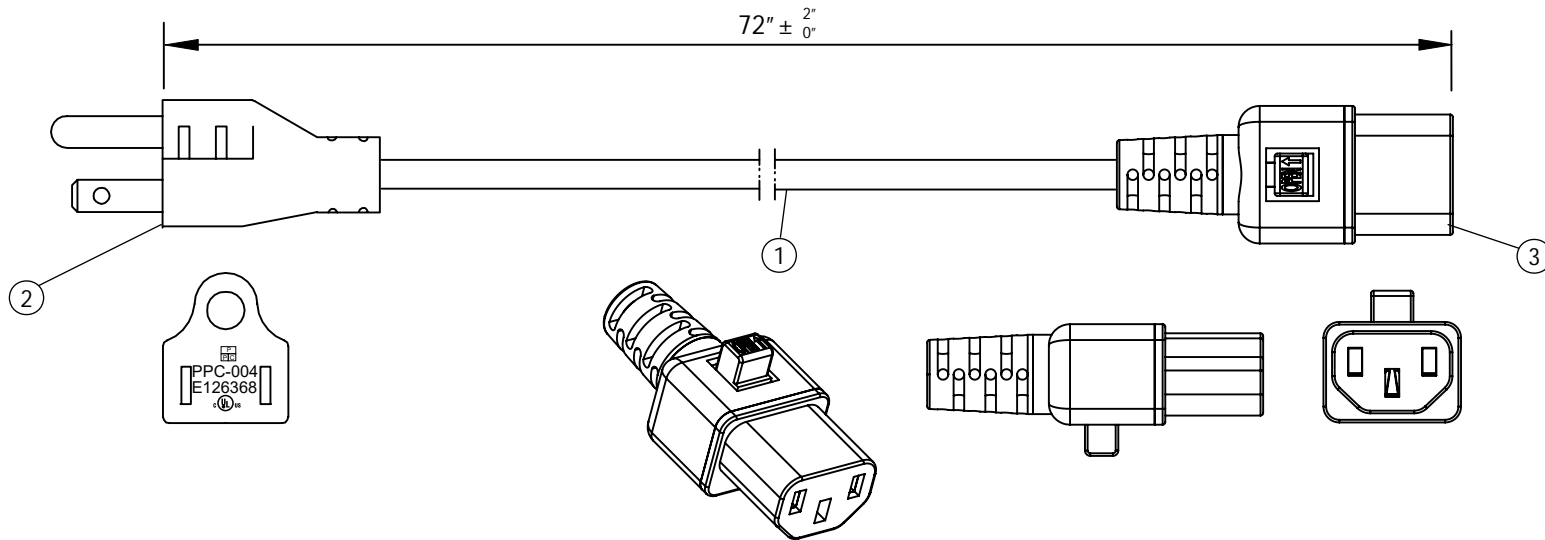

CONTROLLED

NOTES:

1. CORDAGE: SJTW, 14AWG / 3C, UNSHIELDED, NA COLOR CODE, TEMP. RATING: 105°C, RATING: 125V 15A, JACKET COLOR: BLACK
2. PLUG: NEMA 5-15P
3. CONNECTOR: LOCKING IEC 60320 C13
4. APPROVALS: UL, cUL
5. ROHS COMPLIANT
6. LOCKING CONNECTOR RATED UP TO MAXIMUM 35LBS.

Dim range (mm)		Tolerance +/- (mm)		Qualtek Electronics Corp. PPC DIVISION		
0-1	0.15	Part Number: 512012-01		RoHS Compliant		
1-6	0.20	Description: LOCKING POWER CORD				
6-18	0.30	UNIT: in				
18-50	0.50	Drawn / Date	Checked / Date	Approved / Date		
50-120	0.70	R. Nuti 03-28-23	03-28-23	LY / 03-28-23		
120-250	0.90					
250-500	1.20					