

# 6-Pin General Purpose Phototransistor Optocouplers

## 4N25M, 4N26M, 4N27M, 4N28M, 4N35M, 4N36M, 4N37M

### Description

The general purpose optocouplers consist of a gallium arsenide infrared emitting diode driving a silicon phototransistor in a standard plastic 6-pin dual-in-line package.

### Features

- Minimum Current Transfer Ratio at  $I_F = 10 \text{ mA}$ ,  $V_{CE} = 10 \text{ V}$ :
  - ◆ 10% for 4N27M and 4N28M
  - ◆ 20% for 4N25M and 4N26M
  - ◆ 100% for 4N35M and 4N36M and 4N37M
- Safety and Regulatory Approvals:
  - ◆ UL1577, 4,170 VAC<sub>RMS</sub> for 1 Minute
  - ◆ DIN-EN/IEC60747-5-5, 850 V Peak Working Insulation Voltage

### Applications

- Power Supply Regulators
- Digital Logic Inputs
- Microprocessor Inputs

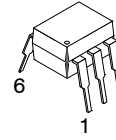

PDIP6  
CASE 646BX

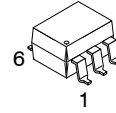

PDIP6  
S SUFFIX  
CASE 646BY

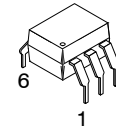

PDIP6  
T SUFFIX  
CASE 646BZ

### MARKING DIAGRAM

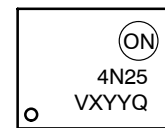

- ON = Logo
- 4N25 = Specific Device Code
- V = DIN EN/IEC60747-5-5 Option (only appears on component ordered with this option)
- X = One-Digit Year Code
- YY = Digit Work Week
- Q = Assembly Package Code

### SCHEMATIC

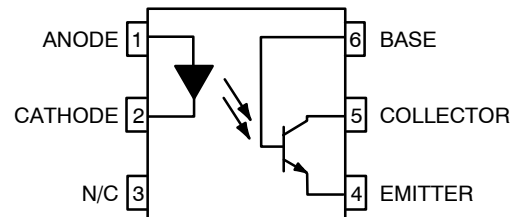

### ORDERING INFORMATION

See detailed ordering and shipping information on page 8 of this data sheet.

## 4N25M, 4N26M, 4N27M, 4N28M, 4N35M, 4N36M, 4N37M

**SAFETY AND INSULATION RATINGS** (As per DIN EN/IEC 60747-5-5, this optocoupler is suitable for “safe electrical insulation” only within the safety limit data. Compliance with the safety ratings shall be ensured by means of protective circuits.)

Parameter		Characteristics
Installation Classifications per DIN VDE 0110/1.89 Table 1, For Rated Mains Voltage	<150 V <sub>RMS</sub>	I-IV
	<300 V <sub>RMS</sub>	I-IV
Climatic Classification		55/100/21
Pollution Degree (DIN VDE 0110/1.89)		2
Comparative Tracking Index		175

Symbol	Parameter	Value	Unit
V <sub>PR</sub>	Input-to-Output Test Voltage, Method A, V <sub>IORM</sub> × 1.6 = V <sub>PR</sub> , Type and Sample Test with t <sub>m</sub> = 10 s, Partial Discharge < 5 pC	1360	V <sub>peak</sub>
	Input-to-Output Test Voltage, Method B, V <sub>IORM</sub> × 1.875 = V <sub>PR</sub> , 100% Production Test with t <sub>m</sub> = 1 s, Partial Discharge < 5 pC	1594	V <sub>peak</sub>
V <sub>IORM</sub>	Maximum Working Insulation Voltage	850	V <sub>peak</sub>
V <sub>IOTM</sub>	Highest Allowable Over-Voltage	6000	V <sub>peak</sub>
	External Creepage	≥7	mm
	External Clearance	≥7	mm
	External Clearance (for Option TV, 0.4" Lead Spacing)	≥10	mm
DTI	Distance Through Insulation (Insulation Thickness)	≥0.5	mm
T <sub>S</sub>	Case Temperature (Note 1)	175	°C
I <sub>S,INPUT</sub>	Input Current (Note 1)	350	mA
P <sub>S,OUTPUT</sub>	Output Power (Note 1)	800	mW
R <sub>IO</sub>	Insulation Resistance at T <sub>S</sub> , V <sub>IO</sub> = 500 V (Note 1)	>10 <sup>9</sup>	Ω

1. Safety limit values – maximum values allowed in the event of a failure.

## 4N25M, 4N26M, 4N27M, 4N28M, 4N35M, 4N36M, 4N37M

### ABSOLUTE MAXIMUM RATINGS

Symbol	Parameter	Max	Unit
--------	-----------	-----	------

#### TOTAL DEVICE

T <sub>STG</sub>	Storage Temperature	-40 to +125	°C
T <sub>OPR</sub>	Operating Temperature	-40 to +100	°C
T <sub>J</sub>	Junction Temperature	-40 to +125	°C
T <sub>SOL</sub>	Lead Solder Temperature	260 for 10 seconds	°C
P <sub>D</sub>	Total Device Power Dissipation @ T <sub>A</sub> = 25°C	270	mW
	Derate Above 25°C	2.94	mW/°C

#### EMITTER

I <sub>F</sub>	DC / Average Forward Input Current	60	mA
V <sub>R</sub>	Reverse Input Voltage	6	V
I <sub>F(pk)</sub>	Forward Current – Peak (300 μs, 2% Duty Cycle)	3	A
P <sub>D</sub>	LED Power Dissipation @ T <sub>A</sub> = 25°C	120	mW
	Derate Above 25°C	1.41	mW/°C

#### DETECTOR

V <sub>CEO</sub>	Collector-to-Emitter Voltage	30	V
V <sub>CBO</sub>	Collector-to-Base Voltage	70	V
V <sub>ECO</sub>	Emitter-to-Collector Voltage	7	V
P <sub>D</sub>	Detector Power Dissipation @ T <sub>A</sub> = 25°C	150	mW
	Derate Above 25°C	1.76	mW/°C

Stresses exceeding those listed in the Maximum Ratings table may damage the device. If any of these limits are exceeded, device functionality should not be assumed, damage may occur and reliability may be affected.

## 4N25M, 4N26M, 4N27M, 4N28M, 4N35M, 4N36M, 4N37M

### ELECTRICAL CHARACTERISTICS – INDIVIDUAL COMPONENT CHARACTERISTICS

( $T_A = 25^\circ\text{C}$  unless otherwise noted)

Symbol	Parameter	Test Conditions	Min	Typ	Max	Unit
<b>EMITTER</b>						
$V_F$	Input Forward Voltage	$I_F = 10\text{ mA}$	–	1.18	1.50	V
$I_R$	Reverse Leakage Current	$V_R = 6.0\text{ V}$	–	0.001	10	$\mu\text{A}$

### DETECTOR

$BV_{CEO}$	Collector-to-Emitter Breakdown Voltage	$I_C = 1.0\text{ mA}, I_F = 0$	30	100	–	V
$BV_{CBO}$	Collector-to-Base Breakdown Voltage	$I_C = 100\ \mu\text{A}, I_F = 0$	70	120	–	V
$BV_{ECO}$	Emitter-to-Collector Breakdown Voltage	$I_E = 100\ \mu\text{A}, I_F = 0$	7	10	–	V
$I_{CEO}$	Collector-to-Emitter Dark Current	$V_{CE} = 10\text{ V}, I_F = 0$	–	1	50	nA
$I_{CBO}$	Collector-to-Base Dark Current	$V_{CB} = 10\text{ V}$	–	–	20	nA
$C_{CE}$	Capacitance	$V_{CE} = 0\text{ V}, f = 1\text{ MHz}$	–	8	–	pF

Product parametric performance is indicated in the Electrical Characteristics for the listed test conditions, unless otherwise noted. Product performance may not be indicated by the Electrical Characteristics if operated under different conditions.

### ELECTRICAL CHARACTERISTICS – TRANSFER CHARACTERISTICS ( $T_A = 25^\circ\text{C}$ unless otherwise noted)

Symbol	Parameter	Test Conditions	Device	Min	Typ	Max	Unit
--------	-----------	-----------------	--------	-----	-----	-----	------

#### DC CHARACTERISTICS

CTR	Current Transfer Ratio, Collector-to-Emitter	$I_F = 10\text{ mA}, V_{CE} = 10\text{ V}$	4N35M, 4N36M, 4N37M	100	–	–	%
			4N25M, 4N26M	20	–	–	
			4N27M, 4N28M	10	–	–	
		$I_F = 10\text{ mA}, V_{CE} = 10\text{ V}, T_A = -55^\circ\text{C}$	4N35M, 4N36M, 4N37M	40	–	–	
		$I_F = 10\text{ mA}, V_{CE} = 10\text{ V}, T_A = +100^\circ\text{C}$	4N35M, 4N36M, 4N37M	40	–	–	
$V_{CE(SAT)}$	Collector-to-Emitter Saturation Voltage	$I_C = 2\text{ mA}, I_F = 50\text{ mA}$	4N25M, 4N26M, 4N27M, 4N28M	–	–	0.5	V
		$I_C = 0.5\text{ mA}, I_F = 10\text{ mA}$	4N35M, 4N36M, 4N37M	–	–	0.3	

#### AC CHARACTERISTIC

$T_{ON}$	Non-Saturated Turn-on Time	$I_F = 10\text{ mA}, V_{CC} = 10\text{ V}, R_L = 100\ \Omega$ (Figure 11)	4N25M, 4N26M, 4N27M, 4N28M	–	2	–	$\mu\text{s}$
		$I_C = 2\text{ mA}, V_{CC} = 10\text{ V}, R_L = 100\ \Omega$ (Figure 11)	4N35M, 4N36M, 4N37M	–	2	10	
$T_{OFF}$	Turn-off Time	$I_F = 10\text{ mA}, V_{CC} = 10\text{ V}, R_L = 100\ \Omega$ (Figure 11)	4N25M, 4N26M, 4N27M, 4N28M	–	2	–	$\mu\text{s}$
		$I_C = 2\text{ mA}, V_{CC} = 10\text{ V}, R_L = 100\ \Omega$ (Figure 11)	4N35M, 4N36M, 4N37M	–	2	10	

Product parametric performance is indicated in the Electrical Characteristics for the listed test conditions, unless otherwise noted. Product performance may not be indicated by the Electrical Characteristics if operated under different conditions.

### ELECTRICAL CHARACTERISTICS – ISOLATION CHARACTERISTICS ( $T_A = 25^\circ\text{C}$ unless otherwise noted)

Symbol	Parameter	Test Conditions	Min	Typ	Max	Unit
$V_{ISO}$	Input-Output Isolation Voltage	$t = 1\text{ Minute}$	4170	–	–	$V_{AC_{RMS}}$
$C_{ISO}$	Isolation Capacitance	$V_{I-O} = 0\text{ V}, f = 1\text{ MHz}$	–	0.2	–	pF
$R_{ISO}$	Isolation Resistance	$V_{I-O} = \pm 500\text{ VDC}, T_A = 25^\circ\text{C}$	$10^{11}$	–	–	$\Omega$

Product parametric performance is indicated in the Electrical Characteristics for the listed test conditions, unless otherwise noted. Product performance may not be indicated by the Electrical Characteristics if operated under different conditions.

TYPICAL PERFORMANCE CURVES

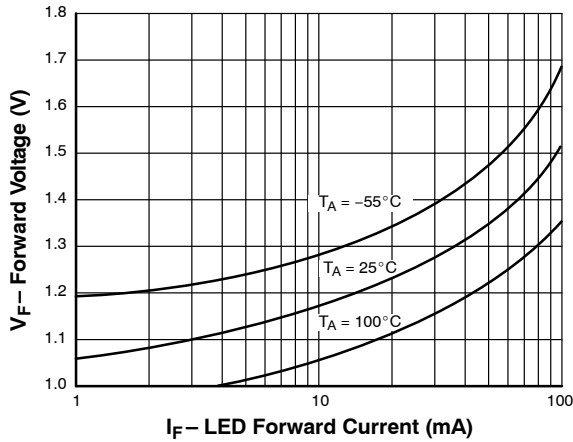

Figure 1. LED Forward Voltage vs. Forward Current

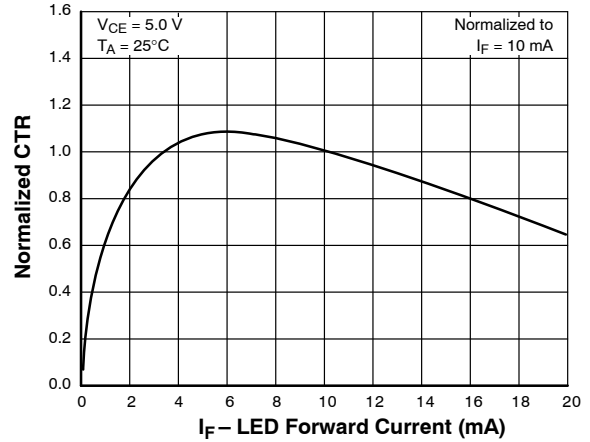

Figure 2. Normalized CTR vs. Forward Current

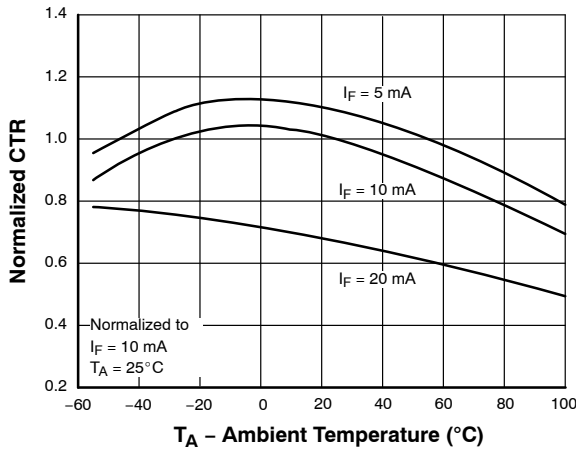

Figure 3. Normalized CTR vs. Ambient Temperature

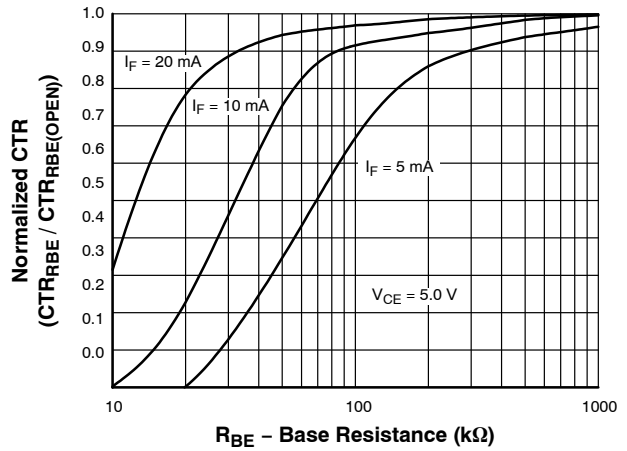

Figure 4. CTR vs. RBE (Unsaturated)

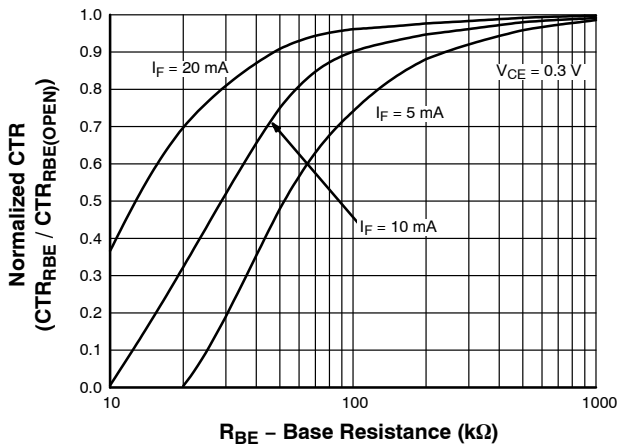

Figure 5. CTR vs. RBE (Saturated)

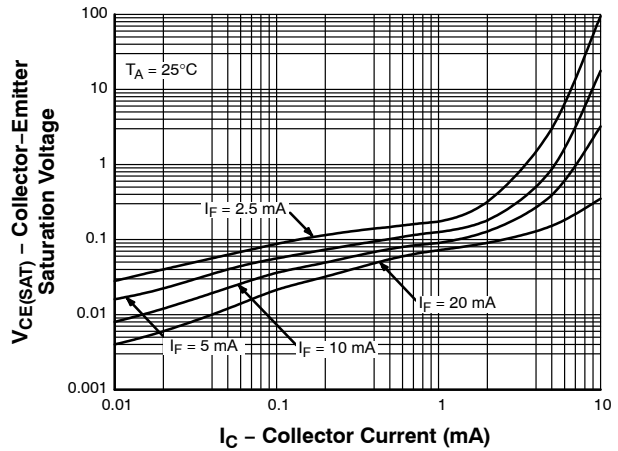

Figure 6. Collector-Emitter Saturation Voltage vs. Collector Current

# 4N25M, 4N26M, 4N27M, 4N28M, 4N35M, 4N36M, 4N37M

## TYPICAL PERFORMANCE CURVES (continued)

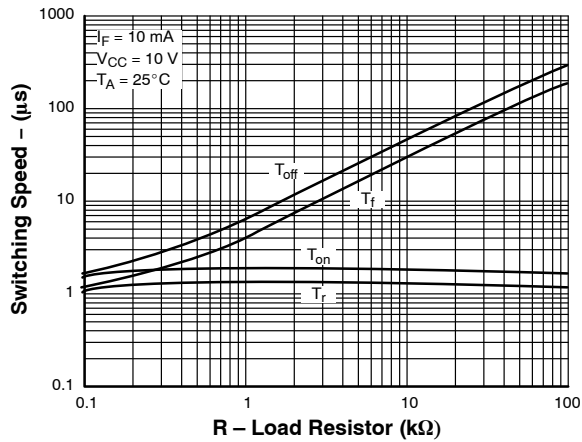

Figure 7. Switching Speed vs. Load Resistor

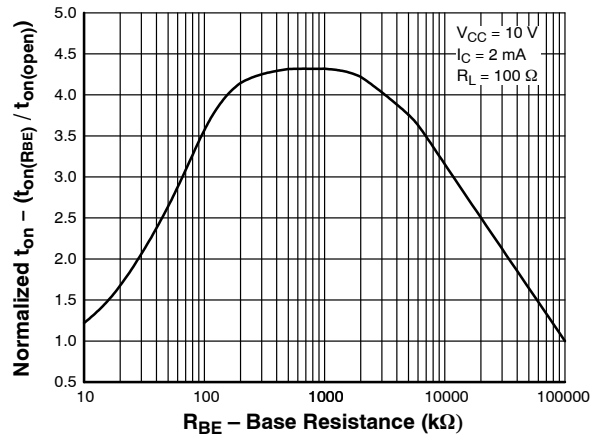

Figure 8. Normalized ton vs. RBE

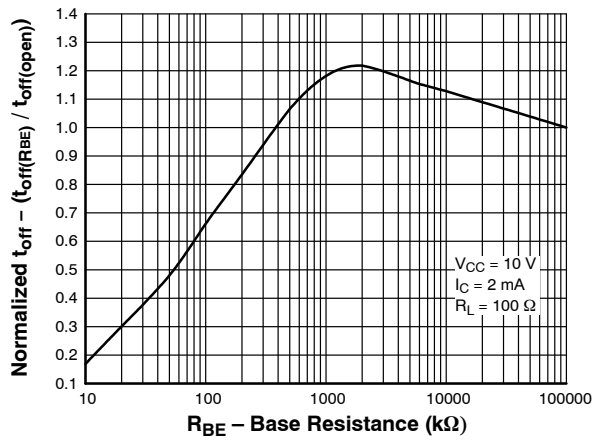

Figure 9. Normalized toff vs. RBE

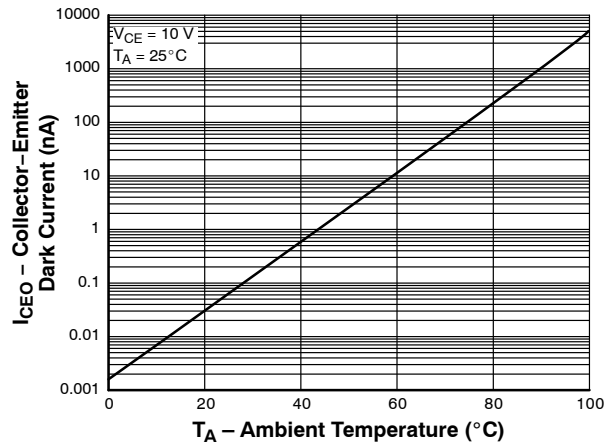

Figure 10. Dark Current vs. Ambient Temperature

## SWITCHING TIME TEST CIRCUIT AND WAVEFORMS

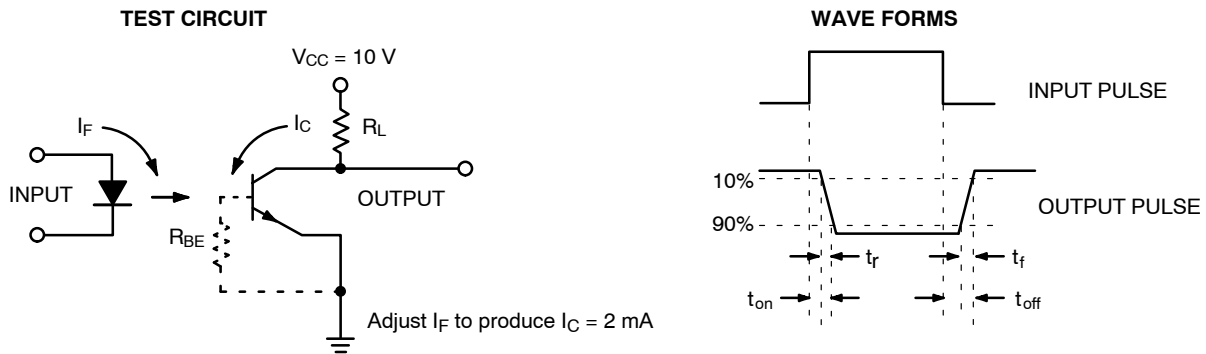
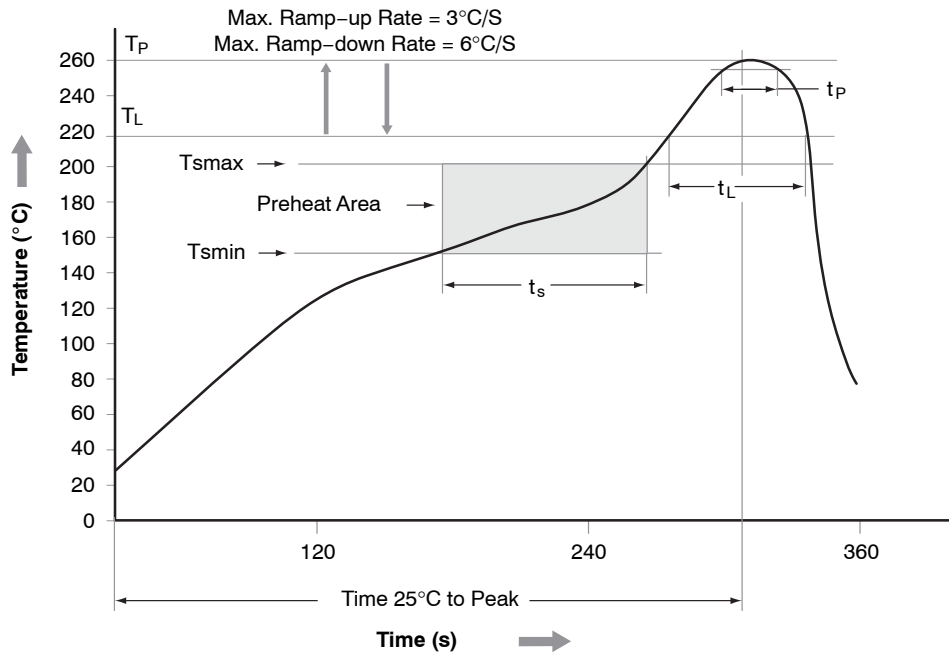

Figure 11. Switching Time Test Circuit and Waveform

REFLOW PROFILE



Profile Feature	Pb-Free Assembly Profile
Temperature Min. (Tsmmin)	150°C
Temperature Max. (Tsmmax)	200°C
Time (ts) from (Tsmmin to Tsmmax)	60–120 seconds
Ramp-up Rate (tL to tp)	3°C/second max.
Liquidous Temperature (TL)	217°C
Time (tL) Maintained Above (TL)	60–150 seconds
Peak Body Package Temperature	260°C +0°C / -5°C
Time (tp) within 5°C of 260°C	30 seconds
Ramp-down Rate (TP to TL)	6°C/second max.
Time 25°C to Peak Temperature	8 minutes max.

Figure 12. Reflow Profile

## 4N25M, 4N26M, 4N27M, 4N28M, 4N35M, 4N36M, 4N37M

### ORDERING INFORMATION (Note 2)

Part Number	Package	Shipping <sup>†</sup>
4N25M	DIP 6-Pin	50 Units / Tube
4N25SM	SMT 6-Pin (Lead Bend)	50 Units / Tube
4N25SR2M	SMT 6-Pin (Lead Bend)	1000 Units / Tape & Reel
4N25VM	DIP 6-Pin, DIN EN/IEC60747-5-5 Option	50 Units / Tube
4N25SVM	SMT 6-Pin (Lead Bend), DIN EN/IEC60747-5-5 Option	50 Units / Tube
4N25SR2VM	SMT 6-Pin (Lead Bend), DIN EN/IEC60747-5-5 Option	1000 Units / Tape & Reel
4N25TVM	DIP 6-Pin, 0.4" Lead Spacing, DIN EN/IEC60747-5-5 Option	50 Units / Tube

<sup>†</sup>For information on tape and reel specifications, including part orientation and tape sizes, please refer to our Tape and Reel Packaging Specifications Brochure, BRD8011/D.

2. The product orderable part number system listed in this table also applies to the 4N26M, 4N27M, 4N28M, 4N35M, 4N36M, and 4N37M devices.



**MECHANICAL CASE OUTLINE**  
**PACKAGE DIMENSIONS**

PDIP6 8.51x6.35, 2.54P  
CASE 646BX  
ISSUE O

DATE 31 JUL 2016

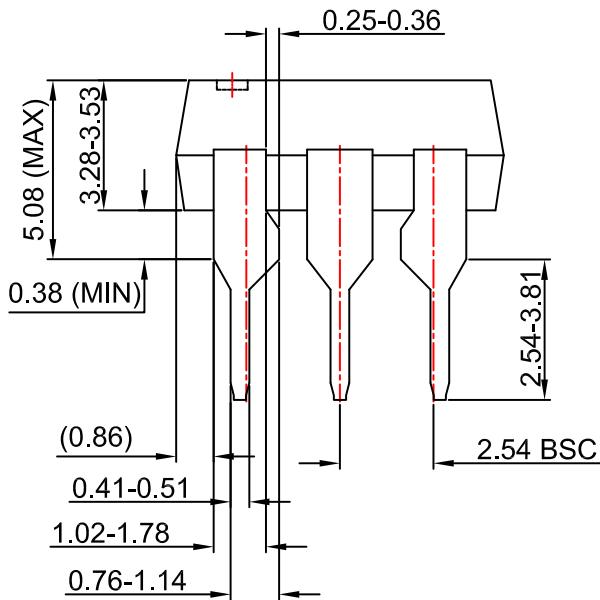
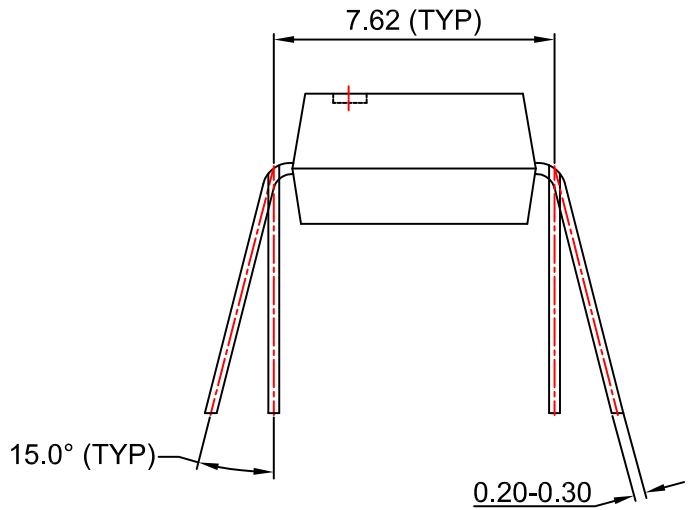
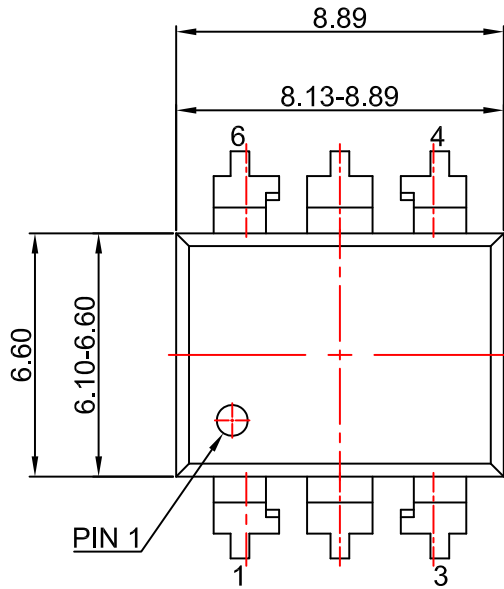

NOTES:

- A) NO STANDARD APPLIES TO THIS PACKAGE.
- B) ALL DIMENSIONS ARE IN MILLIMETERS.
- C) DIMENSIONS ARE EXCLUSIVE OF BURRS, MOLD FLASH, AND TIE BAR EXTRUSION

<b>DOCUMENT NUMBER:</b>	<b>98AON13449G</b>	Electronic versions are uncontrolled except when accessed directly from the Document Repository. Printed versions are uncontrolled except when stamped "CONTROLLED COPY" in red.
<b>DESCRIPTION:</b>	<b>PDIP6 8.51X6.35, 2.54P</b>	<b>PAGE 1 OF 1</b>

ON Semiconductor and are trademarks of Semiconductor Components Industries, LLC dba ON Semiconductor or its subsidiaries in the United States and/or other countries. ON Semiconductor reserves the right to make changes without further notice to any products herein. ON Semiconductor makes no warranty, representation or guarantee regarding the suitability of its products for any particular purpose, nor does ON Semiconductor assume any liability arising out of the application or use of any product or circuit, and specifically disclaims any and all liability, including without limitation special, consequential or incidental damages. ON Semiconductor does not convey any license under its patent rights nor the rights of others.

# MECHANICAL CASE OUTLINE

## PACKAGE DIMENSIONS

ON Semiconductor®



### PDIP6 8.51x6.35, 2.54P CASE 646BY ISSUE A

DATE 15 JUL 2019



**NOTES:**

1. DIMENSIONING AND TOLERANCING PER ASME Y14.5M, 2009.
2. CONTROLLING DIMENSION: MILLIMETERS
3. DIMENSIONS A, A1, AND L ARE MEASURED WITH THE PACKAGE SEATED.
4. DIMENSIONS D, D1, AND E1 DO NOT INCLUDE MOLD FLASH OR PROTRUSIONS. MOLD FLASH OR PROTRUSIONS ARE NOT TO EXCEED 2.54mm.
5. PACKAGE CONTOUR IS OPTIONAL (ROUNDED OR SQUARE CORNERS).
6. CENTER LINE OF CORNER LEADS ARE LOCATED BY LOCATING THE CENTER OF FEATURE b2 AND b3.

DIM	MILLIMETERS		
	MIN.	NOM.	MAX.
A	---	---	4.80
A1	0.38	---	---
A2	3.28	3.40	3.53
A3	2.49 REF		
A4	1.89 REF		
b	0.41	0.46	0.51
b1	0.76	0.92	1.14
b2	0.25	0.28	0.36
b3	1.02	1.40	1.78
b4	1.778 REF		
c	0.20	0.25	0.30
D	8.13	8.51	8.89
D1	0.86 REF		
E	6.10	6.35	6.60
E1	8.43	9.17	9.90
E2	8.13 REF		
e	2.54 BSC		
L	0.16	0.52	0.88

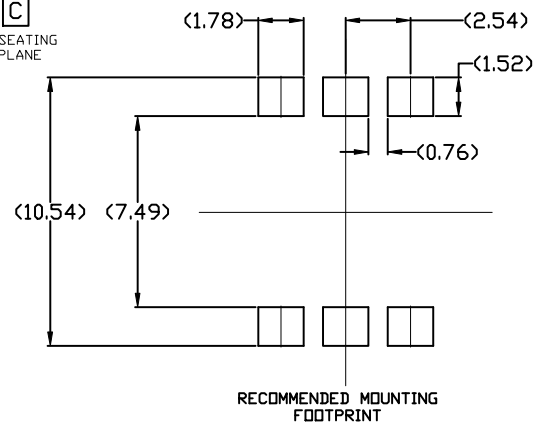

For additional information on our Pb-Free strategy and soldering details, please download the ON Semiconductor Soldering and Mounting Techniques Reference Manual, SOLDERM/D.

<b>DOCUMENT NUMBER:</b>	<b>98AON13450G</b>	Electronic versions are uncontrolled except when accessed directly from the Document Repository. Printed versions are uncontrolled except when stamped "CONTROLLED COPY" in red.
<b>DESCRIPTION:</b>	<b>PDIP6 8.51x6.35, 2.54P</b>	<b>PAGE 1 OF 1</b>

ON Semiconductor and are trademarks of Semiconductor Components Industries, LLC dba ON Semiconductor or its subsidiaries in the United States and/or other countries. ON Semiconductor reserves the right to make changes without further notice to any products herein. ON Semiconductor makes no warranty, representation or guarantee regarding the suitability of its products for any particular purpose, nor does ON Semiconductor assume any liability arising out of the application or use of any product or circuit, and specifically disclaims any and all liability, including without limitation special, consequential or incidental damages. ON Semiconductor does not convey any license under its patent rights nor the rights of others.

**MECHANICAL CASE OUTLINE**  
**PACKAGE DIMENSIONS**

ON Semiconductor®



**PDIP6 8.51x6.35, 2.54P**  
CASE 646BZ  
ISSUE O

DATE 31 JUL 2016

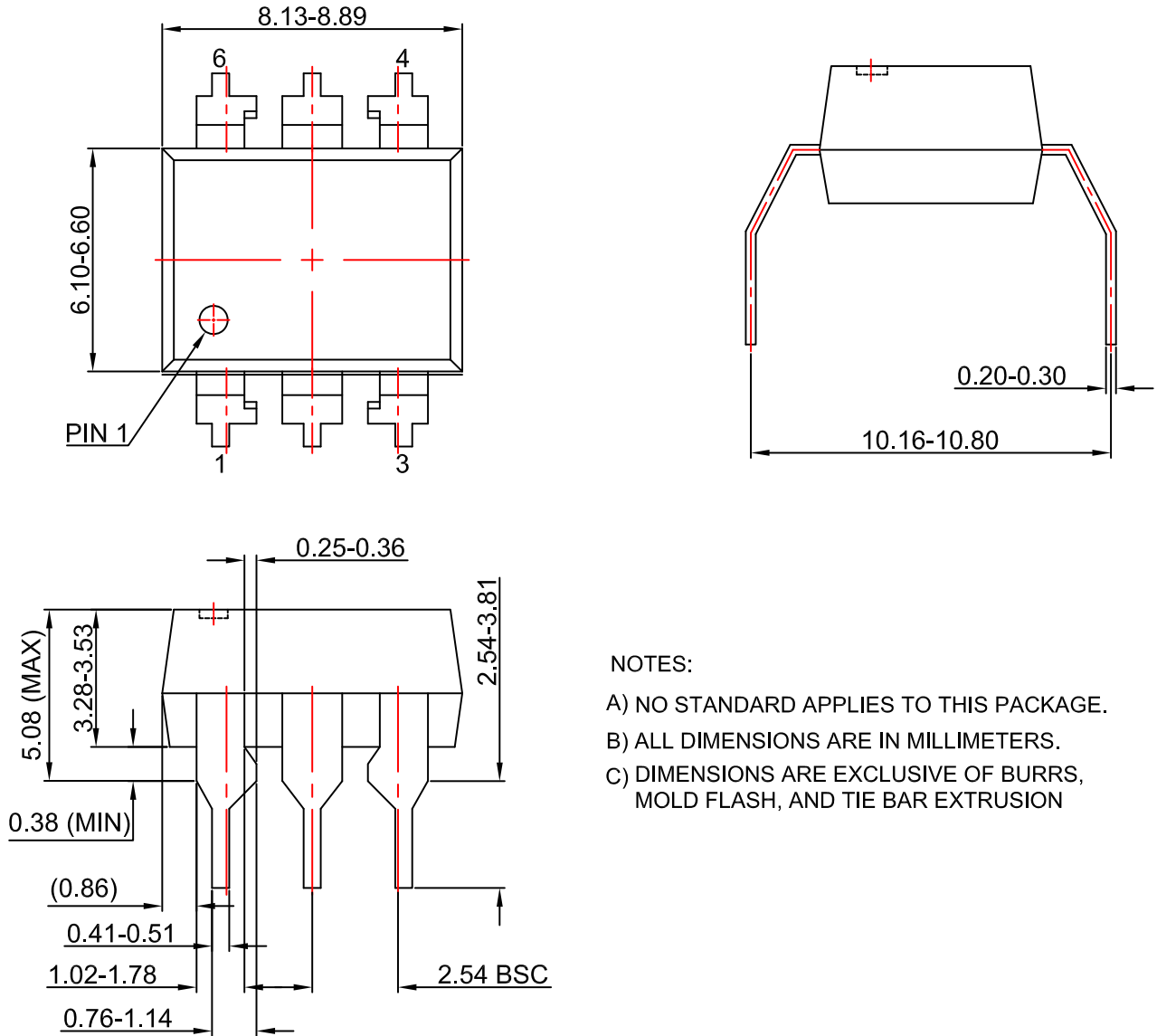

NOTES:

- A) NO STANDARD APPLIES TO THIS PACKAGE.
- B) ALL DIMENSIONS ARE IN MILLIMETERS.
- C) DIMENSIONS ARE EXCLUSIVE OF BURRS, MOLD FLASH, AND TIE BAR EXTRUSION

<b>DOCUMENT NUMBER:</b>	<b>98AON13451G</b>	Electronic versions are uncontrolled except when accessed directly from the Document Repository. Printed versions are uncontrolled except when stamped "CONTROLLED COPY" in red.
<b>DESCRIPTION:</b>	<b>PDIP6 8.51X6.35, 2.54P</b>	<b>PAGE 1 OF 1</b>

ON Semiconductor and are trademarks of Semiconductor Components Industries, LLC dba ON Semiconductor or its subsidiaries in the United States and/or other countries. ON Semiconductor reserves the right to make changes without further notice to any products herein. ON Semiconductor makes no warranty, representation or guarantee regarding the suitability of its products for any particular purpose, nor does ON Semiconductor assume any liability arising out of the application or use of any product or circuit, and specifically disclaims any and all liability, including without limitation special, consequential or incidental damages. ON Semiconductor does not convey any license under its patent rights nor the rights of others.

**onsemi**, **Onsemi**, and other names, marks, and brands are registered and/or common law trademarks of Semiconductor Components Industries, LLC dba "**onsemi**" or its affiliates and/or subsidiaries in the United States and/or other countries. **onsemi** owns the rights to a number of patents, trademarks, copyrights, trade secrets, and other intellectual property. A listing of **onsemi**'s product/patent coverage may be accessed at [www.onsemi.com/site/pdf/Patent-Marking.pdf](http://www.onsemi.com/site/pdf/Patent-Marking.pdf). **onsemi** reserves the right to make changes at any time to any products or information herein, without notice. The information herein is provided "as-is" and **onsemi** makes no warranty, representation or guarantee regarding the accuracy of the information, product features, availability, functionality, or suitability of its products for any particular purpose, nor does **onsemi** assume any liability arising out of the application or use of any product or circuit, and specifically disclaims any and all liability, including without limitation special, consequential or incidental damages. Buyer is responsible for its products and applications using **onsemi** products, including compliance with all laws, regulations and safety requirements or standards, regardless of any support or applications information provided by **onsemi**. "Typical" parameters which may be provided in **onsemi** data sheets and/or specifications can and do vary in different applications and actual performance may vary over time. All operating parameters, including "Typicals" must be validated for each customer application by customer's technical experts. **onsemi** does not convey any license under any of its intellectual property rights nor the rights of others. **onsemi** products are not designed, intended, or authorized for use as a critical component in life support systems or any FDA Class 3 medical devices or medical devices with a same or similar classification in a foreign jurisdiction or any devices intended for implantation in the human body. Should Buyer purchase or use **onsemi** products for any such unintended or unauthorized application, Buyer shall indemnify and hold **onsemi** and its officers, employees, subsidiaries, affiliates, and distributors harmless against all claims, costs, damages, and expenses, and reasonable attorney fees arising out of, directly or indirectly, any claim of personal injury or death associated with such unintended or unauthorized use, even if such claim alleges that **onsemi** was negligent regarding the design or manufacture of the part. **onsemi** is an Equal Opportunity/Affirmative Action Employer. This literature is subject to all applicable copyright laws and is not for resale in any manner.

## ADDITIONAL INFORMATION

### TECHNICAL PUBLICATIONS:

Technical Library: [www.onsemi.com/design/resources/technical-documentation](http://www.onsemi.com/design/resources/technical-documentation)  
onsemi Website: [www.onsemi.com](http://www.onsemi.com)

### ONLINE SUPPORT: [www.onsemi.com/support](http://www.onsemi.com/support)

For additional information, please contact your local Sales Representative at [www.onsemi.com/support/sales](http://www.onsemi.com/support/sales)