

# 3EZ6.2D5 Series

## 3 Watt DO-41 Surmetic 30 Zener Voltage Regulators

This is a complete series of 3 Watt Zener diodes with limits and excellent operating characteristics that reflect the superior capabilities of silicon-oxide passivated junctions. All this in an axial-lead, transfer-molded plastic package that offers protection in all common environmental conditions.

### Specification Features:

- Zener Voltage Range – 6.2 V to 18 V
- ESD Rating of Class 3 (>16 kV) per Human Body Model
- Surge Rating of 98 W @ 1 ms
- Maximum Limits Guaranteed on up to Six Electrical Parameters
- Package No Larger than the Conventional 1 Watt Package
- These are Pb-Free Devices\*

### Mechanical Characteristics:

**CASE:** Void free, transfer-molded, thermosetting plastic

**FINISH:** All external surfaces are corrosion resistant and leads are readily solderable

### MAXIMUM LEAD TEMPERATURE FOR SOLDERING PURPOSES:

260°C, 1/16" from the case for 10 seconds

**POLARITY:** Cathode indicated by polarity band

**MOUNTING POSITION:** Any

### MAXIMUM RATINGS

Rating	Symbol	Value	Unit
Max. Steady State Power Dissipation @ $T_L = 75^\circ\text{C}$ , Lead Length = 3/8" Derate above 75°C	$P_D$	3	W
		24	mW/°C
Steady State Power Dissipation @ $T_A = 50^\circ\text{C}$ Derate above 50°C	$P_D$	1	W
		6.67	mW/°C
Operating and Storage Temperature Range	$T_J, T_{stg}$	-65 to +200	°C

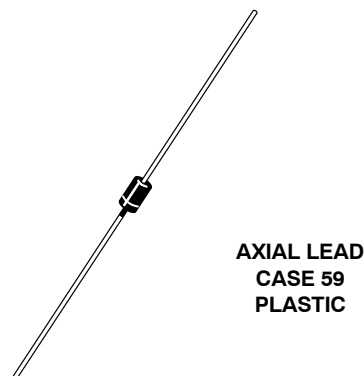
Stresses exceeding those listed in the Maximum Ratings table may damage the device. If any of these limits are exceeded, device functionality should not be assumed, damage may occur and reliability may be affected.

\*For additional information on our Pb-Free strategy and soldering details, please download the ON Semiconductor Soldering and Mounting Techniques Reference Manual, SOLDERRM/D.

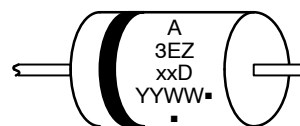


ON Semiconductor®

[www.onsemi.com](http://www.onsemi.com)



### MARKING DIAGRAM



- A = Assembly Location
- 3EZxxD = Device Number
- YY = Year
- WW = Work Week
- = Pb-Free Package

(Note: Microdot may be in either location)

### ORDERING INFORMATION

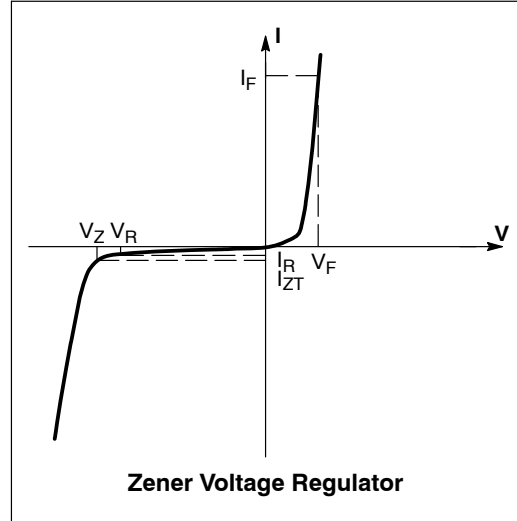
Device	Package	Shipping†
3EZxxD5G	Axial Lead (Pb-Free)	2000 Units / Box
3EZxxD5RLG	Axial Lead (Pb-Free)	6000 / Tape & Reel

†For information on tape and reel specifications, including part orientation and tape sizes, please refer to our Tape and Reel Packaging Specifications Brochure, BRD8011/D.

## 3EZ6.2D5 Series

**ELECTRICAL CHARACTERISTICS** ( $T_A = 25^\circ\text{C}$  unless otherwise noted,  $V_F = 1.5\text{ V Max @ } I_F = 200\text{ mA}$  for all types)

Symbol	Parameter
$V_Z$	Reverse Zener Voltage @ $I_{ZT}$
$I_{ZT}$	Reverse Current
$Z_{ZT}$	Maximum Zener Impedance @ $I_{ZT}$
$I_{ZK}$	Reverse Current
$Z_{ZK}$	Maximum Zener Impedance @ $I_{ZK}$
$I_R$	Reverse Leakage Current @ $V_R$
$V_R$	Breakdown Voltage
$I_F$	Forward Current
$V_F$	Forward Voltage @ $I_F$
$I_{ZM}$	Maximum DC Zener Current
$I_R$	Surge Current @ $T_A = 25^\circ\text{C}$



**ELECTRICAL CHARACTERISTICS** ( $T_A = 25^\circ\text{C}$  unless otherwise noted,  $V_F = 1.5\text{ V Max @ } I_F = 200\text{ mA}$  for all types)

Device† (Note 1)	Device Marking	Zener Voltage (Note 2)				Zener Impedance (Note 3)			Leakage Current		$I_{ZM}$ mA	$I_R$ (Note 4) mA
		$V_Z$ (Volts)			@ $I_{ZT}$	$Z_{ZT}$ @ $I_{ZT}$	$Z_{ZK}$ @ $I_{ZK}$		$I_R$ @ $V_R$			
		Min	Nom	Max	mA	$\Omega$	$\Omega$	mA	$\mu\text{A Max}$	Volts		
3EZ6.2D5RLG	3EZ6.2D	5.89	6.2	6.51	121	1.5	700	1	5	3	435	3.1
3EZ13D5G	3EZ13D	12.35	13	13.65	58	4.5	700	0.25	0.5	9.9	208	1.54
3EZ16D5RLG	3EZ16D	15.2	16	16.8	47	5.5	700	0.25	0.5	12.2	169	1.25
3EZ18D5RLG	3EZ18D	17.1	18	18.9	42	6.0	750	0.25	0.5	13.7	150	1.11

**1. TOLERANCE AND TYPE NUMBER DESIGNATION**

Tolerance designation – device tolerance of  $\pm 5\%$  are indicated by a “5” suffix.

**2. ZENER VOLTAGE ( $V_Z$ ) MEASUREMENT**

ON Semiconductor guarantees the zener voltage when measured at 40 ms  $\pm 10$  ms, 3/8” from the diode body. And an ambient temperature of  $25^\circ\text{C}$  ( $+8^\circ\text{C}$ ,  $-2^\circ\text{C}$ )

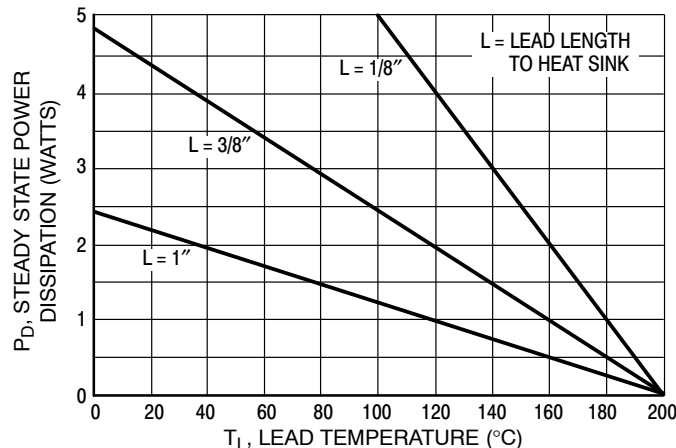
**3. ZENER IMPEDANCE ( $Z_Z$ ) DERIVATION**

The zener impedance is derived from 60 seconds AC voltage, which results when an AC current having an rms value equal to 10% of the DC zener current ( $I_{ZT}$  or  $I_{ZK}$ ) is superimposed on  $I_{ZT}$  or  $I_{ZK}$ .

**4. SURGE CURRENT ( $I_R$ ) NON-REPETITIVE**

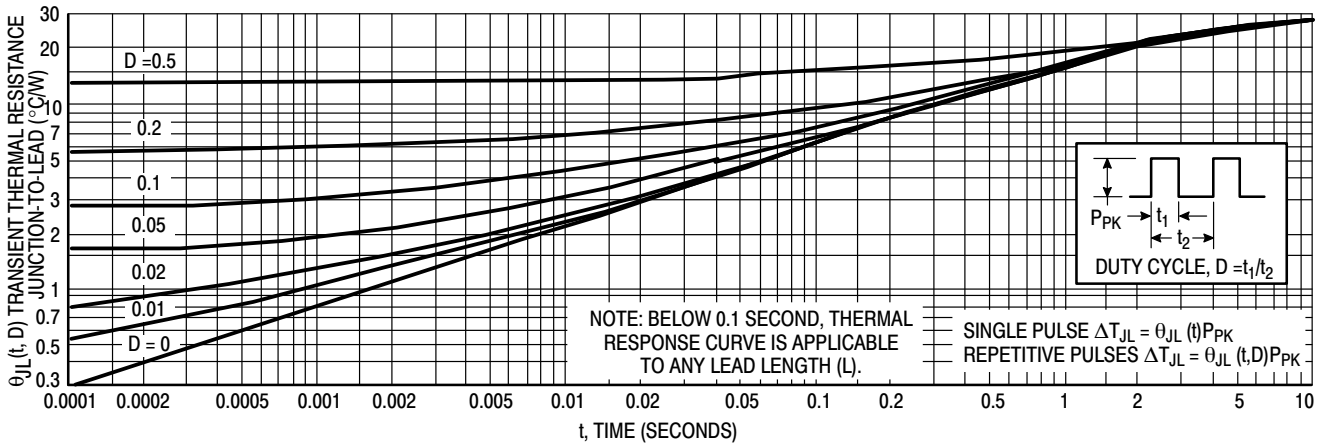
The rating listed in the electrical characteristics table is maximum peak, non-repetitive, reverse surge current of 1/2 square wave or equivalent sine wave pulse of 1/120 second duration superimposed on the test current,  $I_{ZT}$ , per JEDEC standards. However, actual device capability is as described in Figure 3 of the General Data sheet for Surmetic 30s.

†The “G” suffix indicates these are Pb-Free packages.

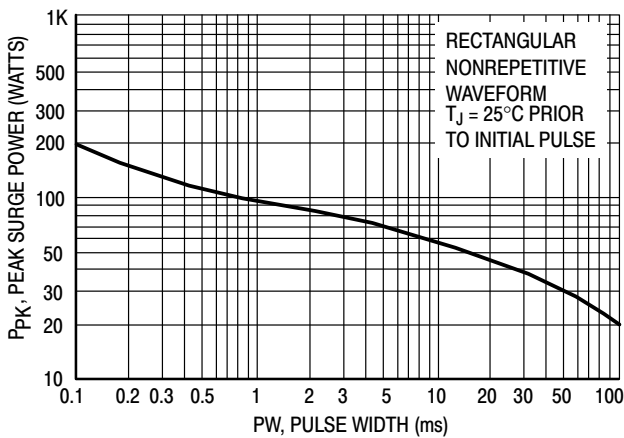


**Figure 1. Power Temperature Derating Curve**

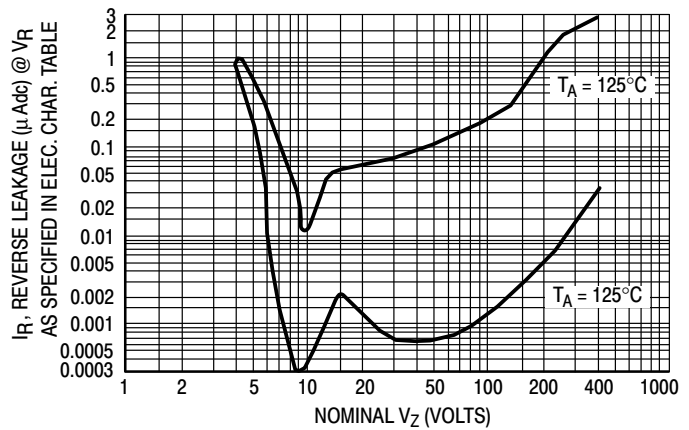
## 3EZ6.2D5 Series



**Figure 2. Typical Thermal Response L, Lead Length = 3/8 Inch**



**Figure 3. Maximum Surge Power**



**Figure 4. Typical Reverse Leakage**

### APPLICATION NOTE

Since the actual voltage available from a given zener diode is temperature dependent, it is necessary to determine junction temperature under any set of operating conditions in order to calculate its value. The following procedure is recommended:

Lead Temperature,  $T_L$ , should be determined from:

$$T_L = \theta_{LA} P_D + T_A$$

$\theta_{LA}$  is the lead-to-ambient thermal resistance ( $^{\circ}\text{C}/\text{W}$ ) and  $P_D$  is the power dissipation. The value for  $\theta_{LA}$  will vary and depends on the device mounting method.  $\theta_{LA}$  is generally  $30\text{--}40^{\circ}\text{C}/\text{W}$  for the various clips and tie points in common use and for printed circuit board wiring.

The temperature of the lead can also be measured using a thermocouple placed on the lead as close as possible to the tie point. The thermal mass connected to the tie point is normally large enough so that it will not significantly respond to heat surges generated in the diode as a result of pulsed operation once steady-state conditions are achieved. Using the measured value of  $T_L$ , the junction temperature may be determined by:

$$T_J = T_L + \Delta T_{JL}$$

$\Delta T_{JL}$  is the increase in junction temperature above the lead temperature and may be found from Figure 2 for a train of power pulses ( $L = 3/8$  inch) or from Figure 10 for dc power.

$$\Delta T_{JL} = \theta_{JL} P_D$$

For worst-case design, using expected limits of  $I_Z$ , limits of  $P_D$  and the extremes of  $T_J$  ( $\Delta T_J$ ) may be estimated. Changes in voltage,  $V_Z$ , can then be found from:

$$\Delta V = \theta_{VZ} \Delta T_J$$

$\theta_{VZ}$ , the zener voltage temperature coefficient, is found from Figures 5 and 6.

Under high power-pulse operation, the zener voltage will vary with time and may also be affected significantly by the zener resistance. For best regulation, keep current excursions as low as possible.

Data of Figure 2 should not be used to compute surge capability. Surge limitations are given in Figure 3. They are lower than would be expected by considering only junction temperature, as current crowding effects cause temperatures to be extremely high in small spots resulting in device degradation should the limits of Figure 3 be exceeded.

# 3EZ6.2D5 Series

## TEMPERATURE COEFFICIENT RANGES

(90% of the Units are in the Ranges Indicated)

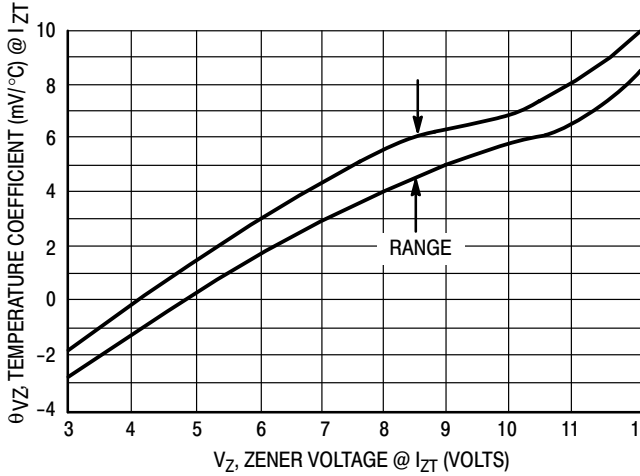


Figure 5. Units to 12 Volts

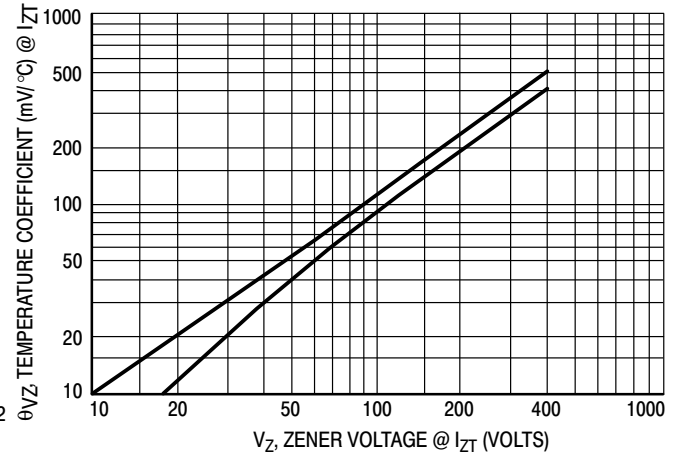


Figure 6. Units 10 to 400 Volts

## ZENER VOLTAGE versus ZENER CURRENT

(Figures 7, 8 and 9)

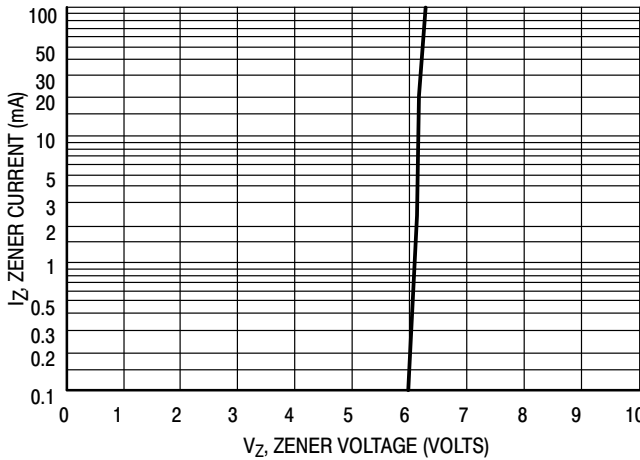


Figure 7.  $V_Z = 3.3$  thru 10 Volts

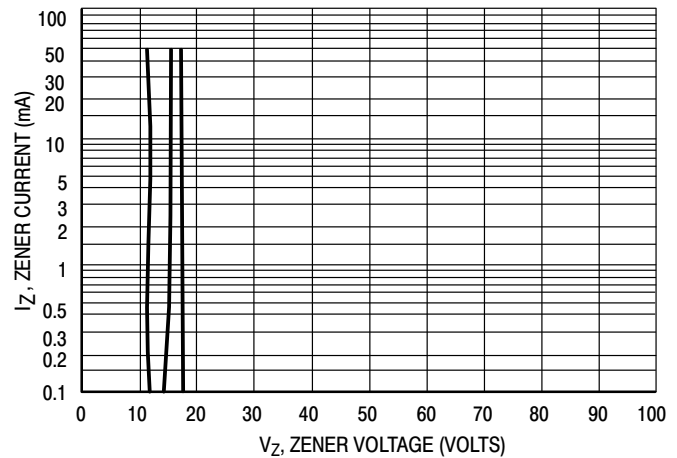


Figure 8.  $V_Z = 12$  thru 82 Volts

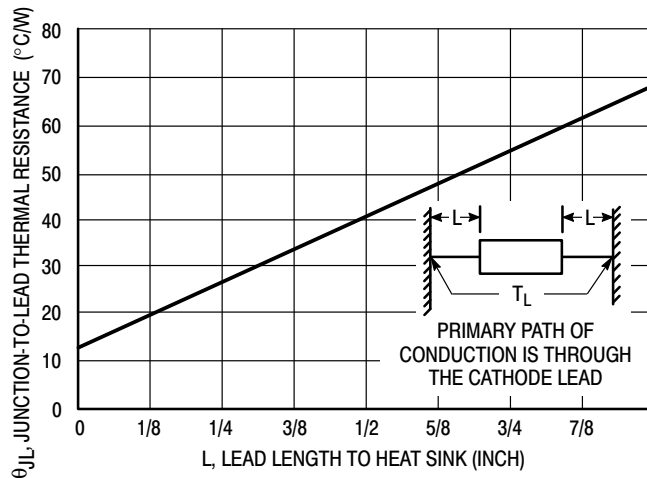


Figure 9. Typical Thermal Resistance

# MECHANICAL CASE OUTLINE

## PACKAGE DIMENSIONS



### AXIAL LEAD CASE 59-10 ISSUE U

DATE 15 FEB 2005



SCALE 1:1

POLARITY INDICATOR  
OPTIONAL AS NEEDED  
(SEE STYLES)

STYLE 1:  
PIN 1. CATHODE (POLARITY BAND)  
2. ANODE

STYLE 2:  
NO POLARITY

NOTES:

1. DIMENSIONING AND TOLERANCING PER ANSI Y14.5M, 1982.
2. CONTROLLING DIMENSION: INCH.
3. ALL RULES AND NOTES ASSOCIATED WITH JEDEC DO-41 OUTLINE SHALL APPLY
4. POLARITY DENOTED BY CATHODE BAND.
5. LEAD DIAMETER NOT CONTROLLED WITHIN F DIMENSION.

DIM	INCHES		MILLIMETERS	
	MIN	MAX	MIN	MAX
A	0.161	0.205	4.10	5.20
B	0.079	0.106	2.00	2.70
D	0.028	0.034	0.71	0.86
F	---	0.050	---	1.27
K	1.000	---	25.40	---

### GENERIC MARKING DIAGRAM\*



- xxx = Specific Device Code
- A = Assembly Location
- YY = Year
- WW = Work Week

\*This information is generic. Please refer to device data sheet for actual part marking. Pb-Free indicator, "G" or microdot "▪", may or may not be present.

<b>DOCUMENT NUMBER:</b>	<b>98ASB42045B</b>	Electronic versions are uncontrolled except when accessed directly from the Document Repository. Printed versions are uncontrolled except when stamped "CONTROLLED COPY" in red.
<b>DESCRIPTION:</b>	<b>AXIAL LEAD</b>	<b>PAGE 1 OF 1</b>

ON Semiconductor and are trademarks of Semiconductor Components Industries, LLC dba ON Semiconductor or its subsidiaries in the United States and/or other countries. ON Semiconductor reserves the right to make changes without further notice to any products herein. ON Semiconductor makes no warranty, representation or guarantee regarding the suitability of its products for any particular purpose, nor does ON Semiconductor assume any liability arising out of the application or use of any product or circuit, and specifically disclaims any and all liability, including without limitation special, consequential or incidental damages. ON Semiconductor does not convey any license under its patent rights nor the rights of others.

**onsemi**, **Onsemi**, and other names, marks, and brands are registered and/or common law trademarks of Semiconductor Components Industries, LLC dba "**onsemi**" or its affiliates and/or subsidiaries in the United States and/or other countries. **onsemi** owns the rights to a number of patents, trademarks, copyrights, trade secrets, and other intellectual property. A listing of **onsemi**'s product/patent coverage may be accessed at [www.onsemi.com/site/pdf/Patent-Marking.pdf](http://www.onsemi.com/site/pdf/Patent-Marking.pdf). **onsemi** reserves the right to make changes at any time to any products or information herein, without notice. The information herein is provided "as-is" and **onsemi** makes no warranty, representation or guarantee regarding the accuracy of the information, product features, availability, functionality, or suitability of its products for any particular purpose, nor does **onsemi** assume any liability arising out of the application or use of any product or circuit, and specifically disclaims any and all liability, including without limitation special, consequential or incidental damages. Buyer is responsible for its products and applications using **onsemi** products, including compliance with all laws, regulations and safety requirements or standards, regardless of any support or applications information provided by **onsemi**. "Typical" parameters which may be provided in **onsemi** data sheets and/or specifications can and do vary in different applications and actual performance may vary over time. All operating parameters, including "Typicals" must be validated for each customer application by customer's technical experts. **onsemi** does not convey any license under any of its intellectual property rights nor the rights of others. **onsemi** products are not designed, intended, or authorized for use as a critical component in life support systems or any FDA Class 3 medical devices or medical devices with a same or similar classification in a foreign jurisdiction or any devices intended for implantation in the human body. Should Buyer purchase or use **onsemi** products for any such unintended or unauthorized application, Buyer shall indemnify and hold **onsemi** and its officers, employees, subsidiaries, affiliates, and distributors harmless against all claims, costs, damages, and expenses, and reasonable attorney fees arising out of, directly or indirectly, any claim of personal injury or death associated with such unintended or unauthorized use, even if such claim alleges that **onsemi** was negligent regarding the design or manufacture of the part. **onsemi** is an Equal Opportunity/Affirmative Action Employer. This literature is subject to all applicable copyright laws and is not for resale in any manner.

## ADDITIONAL INFORMATION

### TECHNICAL PUBLICATIONS:

Technical Library: [www.onsemi.com/design/resources/technical-documentation](http://www.onsemi.com/design/resources/technical-documentation)  
onsemi Website: [www.onsemi.com](http://www.onsemi.com)

### ONLINE SUPPORT: [www.onsemi.com/support](http://www.onsemi.com/support)

For additional information, please contact your local Sales Representative at [www.onsemi.com/support/sales](http://www.onsemi.com/support/sales)