



3S8W_3RP series

3W - Dual/Single Output - Wide Input - Isolated & Regulated DC-DC Converter

DC-DC Converter 3 Watt

- ⊕ 2:1 wide input voltage range
- ⊕ 3kVDC isolation
- ⊕ Short circuit protection (SCP; automatic recovery)
- ⊕ Remote On/Off control
- ⊕ High power density
- ⊕ Operating temperature: -40°C to +85°C
- ⊕ RoHS compliance
- ⊕ Ultra miniature SIP package
- ⊕ EN60950 approved

The 3S8W_3RP Series are isolated 3W DC-DC products with 2:1 input voltage and conventional voltage output. The product has a relatively compact SIP plastic package, and features high efficiency, operating temperature of -40°C to +85 °C. The smaller size and fine cost design make the converter an ideal solution in communication, instruments, and industrial electronics applications.



Common specifications	
Short circuit protection:	Continuous, automatic recovery
Temperature rise at full load:	25°C TYP
Cooling:	Free air convection
Operation temperature range:	-40°C~+85°C
Storage temperature range:	-55°C ~+125°C
Lead temperature range:	300°C MAX, 1.5mm from case for 10 sec
Storage humidity range:	< 95%
Case material:	Plastic [UL94-V0]
MTBF (MIL-HDBK-217F@25°C):	>1,000,000 hours
Weight:	4.9g (typ.)
Dimensions:	22.00 x 9.50 x 12.00 mm

Output specifications					
Item	Test condition	Min	Typ	Max	Units
Output voltage accuracy	5% to 100% load		±1	±3	%
No load output voltage accuracy ¹⁾	Input voltage range		±1.5	±5	%
Output Voltage Balance	Dual output, balanced loads		±0.5	±1	%
Line regulation	Input voltage from low to high, full load		±0.2	±0.5	%
Load regulation	5% to 100% load		±0.4	±0.75	%
Temperature coefficient	100% load		±0.02	±0.03	%/°C
Ripple&Noise ²⁾	20MHz bandwidth		see selection guide		
Transient recovery time	25% load step change		0.5	3	ms
Transient response deviation	25% load step change		±2.5	±5	%
Switching frequency (PFM mode)	100% load, nominal input voltage		250		KHz

Input specifications					
Item	Test condition	Min	Typ	Max	Units
Input current (full load/no load)	• 5VDC input		800/60	846/65	mA
	• 12VDC input		277/25	286/30	mA
	- 3.3V input		314/25	338/30	mA
	- Others				mA
Reflected ripple current	• 24VDC input		140/8	145/13	mA
	- 3.3V input		154/8	163/13	mA
	- Others				mA
	• 48VDC input		69/3	72/10	mA
Input impulse voltage (1 sec. max.)	- 3.3V input		78/3	85/10	mA
	• 5VDC input	-0.7		12	VDC
	• 12VDC input	-0.7		25	VDC
	• 24VDC input	-0.7		50	VDC
Starting voltage	• 48VDC input	-0.7		100	VDC
	• 5VDC input	3.5	4	4.5	VDC
	• 12VDC input	4.5	8	9	VDC
	• 24VDC input	11	16	18	VDC
Input filter	• 48VDC input	24	33	36	VDC
		Filter capacitor			
Hot plug	Unavailable				
Ctrl ¹⁾	• Models ON	The Ctrl end is suspended or of high resistance			
	• Models OFF	Connect with high level (relative to the input grounding) to make the 5-10mA current flows into the Ctrl end.			

- ¹⁾ The max no-load output voltage accuracy for 3S8W_1203S3RP and 3S8W_4803S3RP is ±8%; other products output voltage of 3.3VDC, 5VDC, ±3.3VDC, ±5 VDC output voltage accuracy max is ±5%
- ²⁾ Ripple and noise tested with „parallel cable“ method. See detailed operation instructions at DC-DC application notes; The max output Ripple for 3S8W_2405S3RP is 65mVp-p.

Isolation specifications					
Item	Test condition	Min	Typ	Max	Units
Isolation voltage	Tested for 1 minute, leakage current less than 1 mA	3000			VDC
Isolation resistance	Test at 500VDC	1000			MΩ
Isolation capacitance	Input/Output, 100KHz/0.1V		30	50	pF

Example:
3S8W_0505S3RP
 3 = 3Watt; S8 = SIP8; W = wide input; 4,5 - 9Vin; 05 = 5Vin;
 05 = 5Vout; S = Single Output; 3 = 3000VDC; R = Regulated Output;
 P = Short Curcuit Protection

¹⁾ Please refer to „Application note“ as the direction for use of Ctrl.

3S8W_3RP series

3W - Dual/Single Output - Wide Input - Isolated & Regulated
DC-DC Converter

EMC specifications				
EMI	CE	CISPR22/EN55022 CLASS B (External Circuit Refer to EMC recommended circuit, ^②)		
EMI	RE	CISPR22/EN55022 CLASS B (External Circuit Refer to recommended circuit, ^②)		
EMS	ESD	IEC/EN61000-4-2	Contact ±4KV	perf. Criteria B
EMS	RS	IEC/EN61000-4-3	10V/m	perf. Criteria A
EMS	EFT	IEC/EN61000-4-4	±2KV	perf. Criteria B (External Circuit Refer to EMC recommended circuit, ^①)
EMS	Surge	IEC/EN61000-4-5	±2KV	perf. Criteria B (External Circuit Refer to EMC recommended circuit, ^①)
EMS	CS	IEC/EN61000-4-6	3 Vr.m.s	perf. Criteria A
EMS	Voltage dips, short and interruptions immunity	IEC/EN61000-4-29	0%-70%	perf. Criteria B

Product Selection Guide

Part Number	Input Voltage [VDC]			Output Voltage [VDC]	Output Current [mA]		Ripple&Noise [mVp-p, Typ./Max.]	Capacitive load ²⁾ [μF, Max.]	Efficiency [%, Typ.]
	Nominal	Range	Max ¹⁾		Max	Min			
3S8W_0505S3RP	5	4.5-9	11	5	500	25	40/75	2200	73
3S8W_0509S3RP	5	4.5-9	11	9	278	14	40/75	1000	74
3S8W_0512S3RP	5	4.5-9	11	12	208	10	40/75	680	77
3S8W_0515S3RP	5	4.5-9	11	15	167	8	40/75	470	74
3S8W_1205S3RP	12	9-18	20	5	600	30	40/75	2200	76
3S8W_1209S3RP	12	9-18	20	9	333	17	70/100	1000	79
3S8W_1212S3RP	12	9-18	20	12	250	13	100/150	680	82
3S8W_1215S3RP	12	9-18	20	15	200	10	100/150	470	83
3S8W_1224S3RP	12	9-18	20	24	125	6	100/150	330	81
3S8W_2403S3RP	24	18-36	40	3.3	758	38	40/75	2700	74
3S8W_2405S3RP	24	18-36	40	5	600	30	40/75	2200	81
3S8W_2409S3RP	24	18-36	40	9	333	17	40/75	1000	83
3S8W_2412S3RP	24	18-36	40	12	250	13	40/75	680	83
3S8W_2415S3RP	24	18-36	40	15	200	10	100/150	470	83
3S8W_2424S3RP	24	18-36	40	24	125	6	100/150	330	83
3S8W_4803S3RP	48	36-75	80	3.3	758	38	100/150	2700	75
3S8W_4805S3RP	48	36-75	80	5	600	30	40/75	2200	76
3S8W_4812S3RP	48	36-75	80	12	250	13	40/75	680	80

Part Number	Input Voltage [VDC]			Output Voltage [VDC]	Output Current [mA]		Ripple&Noise [mVp-p, Typ./Max.]	Capacitive load ²⁾ [μF, Max.]	Efficiency [%, Typ.]
	Nominal	Range	Max ¹⁾		Max	Min			
3S8W_0505D3RP	5	4.5-9	11	±5	±250	±13	40/75	1000	74
3S8W_0512D3RP	5	4.5-9	11	±12	±104	±5	40/75	470	77
3S8W_0515D3RP	5	4.5-9	11	±15	±83	±4	40/75	330	77
3S8W_1205D3RP	12	9-18	22	±5	±300	±15	40/75	1000	78
3S8W_1212D3RP	12	9-18	22	±12	±125	±6	40/75	470	79
3S8W_1215D3RP	12	9-18	22	±15	±100	±5	40/75	330	80
3S8W_2405D3RP	24	18-36	40	±5	±300	±15	40/75	1000	79
3S8W_2409D3RP	24	18-36	40	±9	±167	±8	40/75	680	81
3S8W_2412D3RP	24	18-36	40	±12	±125	±6	40/75	470	83
3S8W_2415D3RP	24	18-36	40	±15	±100	±5	40/75	330	83
3S8W_4805D3RP	48	36-75	80	±5	±300	±15	40/75	1000	79
3S8W_4812D3RP	48	36-75	80	±12	±125	±6	40/75	470	82
3S8W_4815D3RP	48	36-75	80	±15	±100	±5	40/75	330	82

¹⁾ Absolute maximum rating without damage on the converter, but it isn't recommended;

²⁾ For dual output converter, the given value is the same for each output.

3S8W_3RP series

3W - Dual/Single Output - Wide Input - Isolated & Regulated DC-DC Converter

Typical characteristics

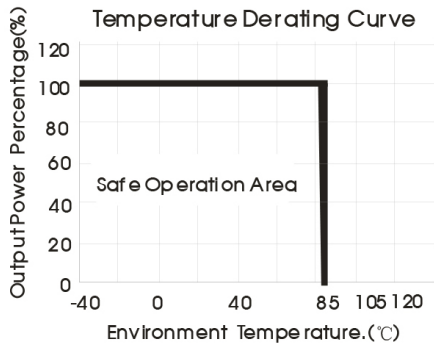

Efficiency

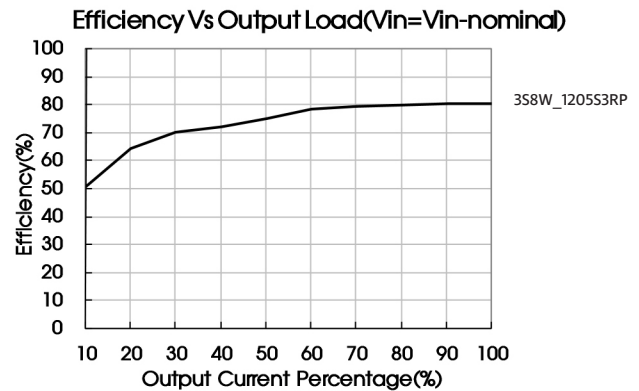
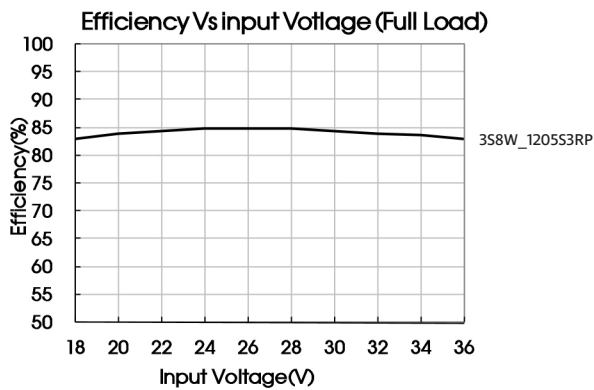
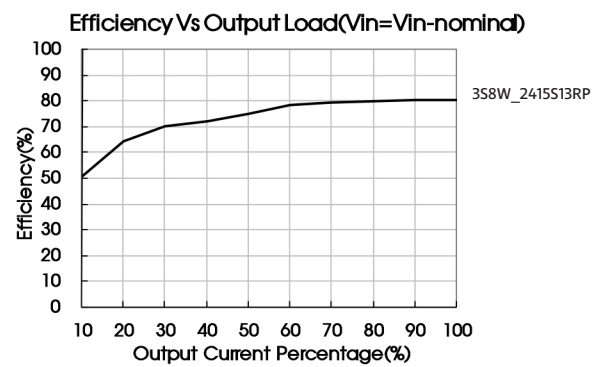
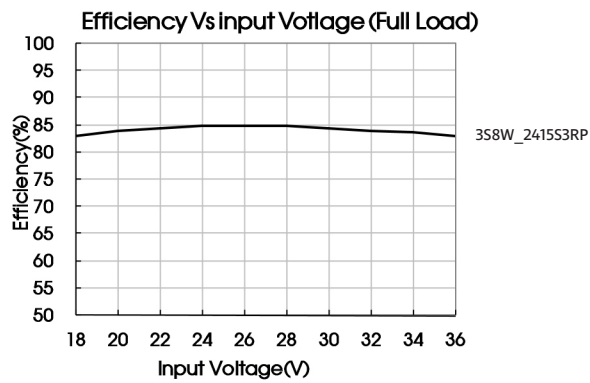

3S8W_3RP series

3W - Dual/Single Output - Wide Input - Isolated & Regulated
DC-DC Converter

Recommended circuit

All the DC/DC converters of this series are tested according to the recommended circuit before delivery.
If a further decrease of the input and output ripple is required, properly increase the input & output of additional capacitors Cin1, Cin2, Cs and Cout; or select capacitors of low equivalent impedance like series

capacitor, etc. Cs is used to reduce ripple. No need to add Cs, if ripple meets the demand. Appropriate filter capacitance shall be chosen, start-up problems may be caused if the capacitance is too large. For each output circuit, under the condition of safe and reliable operation, the max. capacity of its filter capacitor should be lower than the max. capacitive load.

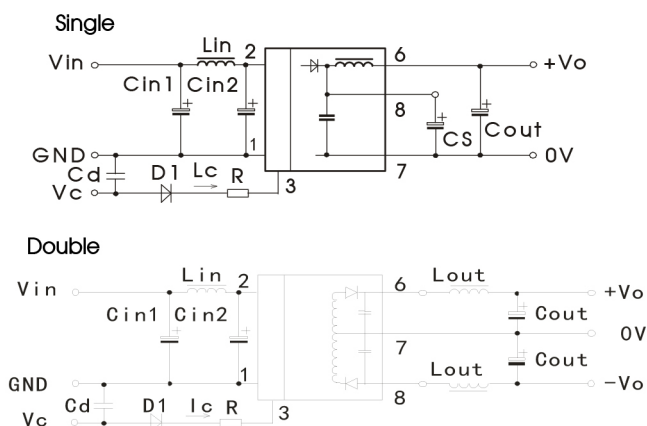

Vin	5VDC&12VDC	24VDC&48VDC
Cin1	100μF	10μF
Cin2	47μF	1μF
Lin	4.7μH~12μH	
Cs	10μF~22μF	
Cout	100μF(Typ.)	
Cd	47nF/100V	

EMC solution-recommended circuit

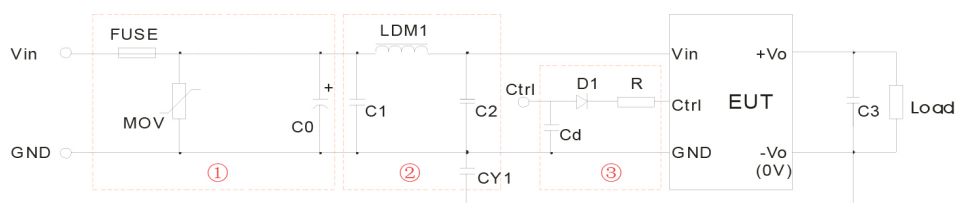

Recommended external circuit parameters:

Model	Vin: 5V	Vin: 12V	Vin: 24V	Vin: 48V
FUSE	Slow blown fuses according to the actual input current selections of the clients			
MOV	-	S14K20	S20K30	S14K60
LDM1	12μH			
C0	680μF/25V		330μF/50V	330μF/100V
C1, C2	4.7μF/50V			4.7μF/100V
C3	Refer to the Cout in recommended circuit			
CY1	1nF/3KV			
D1	RB160M-60/1A			
R	Follows: $R = \frac{V_C - V_D - 1.0}{I_C} - 300$			
Cd	47nF/100V			

Note:

- Part ① is used for EMS test, part ② is used for EMI filtering. Choose according to requirements.
- Vc is the voltage of the Ctrl end relative to the GND of the input grounding; Vd is the positive-going conduction pressure drop of D1; Ic is the current flows into the Ctrl end and its value is generally 5-10mA, see part ③ for the peripheral circuit of Ctrl end;
- If there is no recommended parameters, no external component is required.

3S8W_3RP series

3W - Dual/Single Output - Wide Input - Isolated & Regulated
DC-DC Converter

Ctrl end

The modules are of normal output when the Ctrl end is suspended or of high resistance; the modules turn off when connecting with high level (relative to the input grounding); notice that the current flows into the pin shall be 5 - 10mA, the modules will be permanently damaged if the current exceeds its max. value (20mA in general).

The value of R can be derived as follows:

$$R = \frac{V_C - V_D - 1.0}{I_C} - 300$$

For detailed parameters, please refer to EMC solution-recommended circuit in this manual.

Input current

When the electricity is provided by the unstable power supply, please make sure that the range of the output voltage fluctuation and the ripple voltage of the power supply do not exceed the indicators of the modules. Input current of power supply should afford the flash startup current of this kind of DC/DC module.

Generally: Vin= 5V series lave = 1315mA
Vin=12V series lave = 631mA
Vin=24V series lave = 303mA
Vin=48V series lave = 158mA

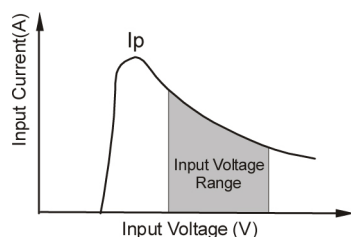

Output load requirements

When using, the minimum load of the module output should not be less than 5% of the nominal load. In order to meet the performance parameters of this datasheet, please connect a 5% dummy load in parallel at the output end, the dummy load is generally a resistor, please note that the resistor needs to be used in derating.

3S8W_3RP series

3W - Dual/Single Output - Wide Input - Isolated & Regulated
DC-DC Converter

Mechanical dimensions

THIRD ANGLE PROJECTION 

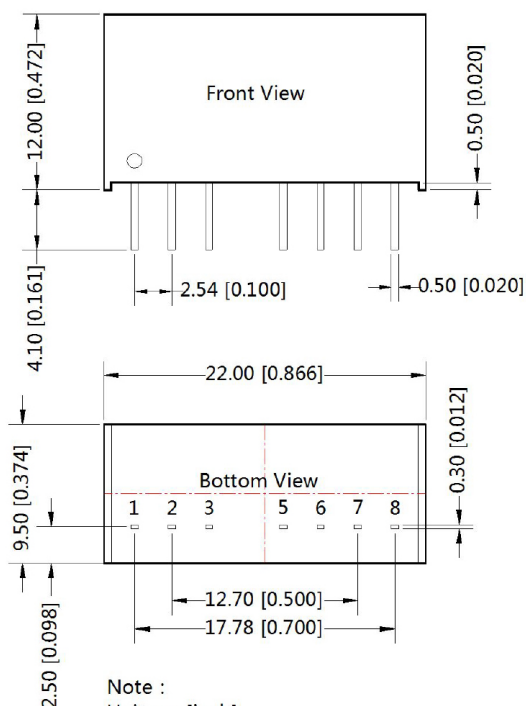

Note :
Unit:mm[inch]
Pin section tolerances:±0.10[±0.004]
General tolerances:±0.25[±0.010]

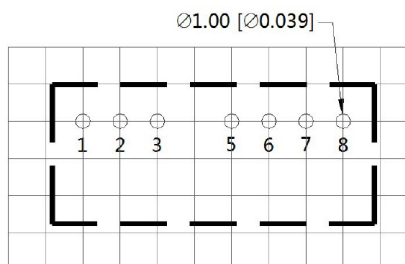

Note : Grid 2.54*2.54mm

Pin-Out		
Pin	Single	Dual
1	GND	GND
2	V _{in}	V _{in}
3	Ctrl	Ctrl
5	NC	NC
6	+V _o	+V _o
7	0V	0V
8	CS	-V _o

NC: No connection

Note:

1. Min. load shouldn't be less than 5%, otherwise ripple maybe increased dramatically. If the product operates under min. load, it may not be guaranteed to meet all specifications listed. Operation under minimum load will not damage the converter.
2. Recommended Dual output models unbalanced load is ≤±5%, if the product operates >±5%, it may not be guaranteed to meet all specifications listed. Please contact our technical support for more details.
3. Max. Capacitive Load is tested at input voltage range and full load.
4. All specifications measured at T_a = 25°C, humidity <75%, nominal input voltage and rated output load unless otherwise specified.
5. In this datasheet, all test methods are based on our corporate standards.
6. All characteristics are for listed models, and non-standard models may perform differently. Please contact our technical support for more details.
7. Please contact our technical support for any specific requirement.
8. Specifications of this product are subject to changes without prior notice.