

## EPIC® HB 10 standard hood

Single-entry hood with single lever bolts

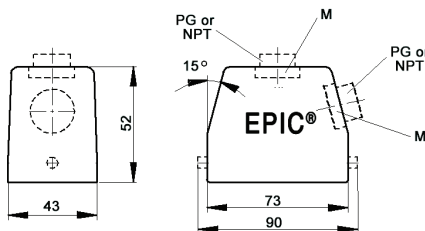
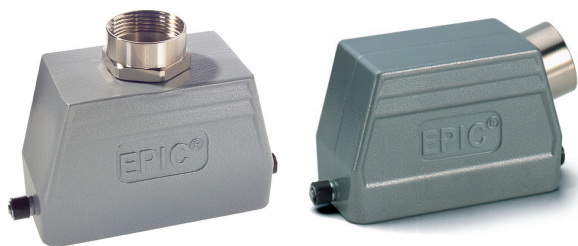

all dimensions are in mm

### Technical data

**IP Protection class:** UL 50E Type 12  
NEMA 4  
IP65

### Complete the installation

 HB dust covers  
page 429

### Approvals



### PG

size	PG hood		SKINTOP® gland	
	part number	plastic	metal	
<b>Top entry</b>				
PG 16	100409	53015040	52015740	
PG 21	100407	53015050	52015750	
<b>Side entry</b>				
PG 16	100429	53015040	52015740	
PG 21	100428	53015050	52015750	

PG hood provided with EPIC® SM/SP gland

### NPT

size	NPT hood		SKINTOP® gland	
	part number	plastic	metal	
<b>Top entry</b>				
1/2"	100409NP	S1112	53112024	
3/4"	100407NP	S1134	53112034	
<b>Side entry</b>				
1/2"	100429NP	S1112	53112024	
3/4"	100428NP	S1134	53112034	

NPT hood provided with NPT fitting

### metric

size	Metric hood		SKINTOP® gland	
	part number	plastic	metal	
<b>Top entry*</b>				
M20	19040900	53111020	53112020	
M25	19040700	53111030	53112030	
<b>Side entry</b>				
M20	19042900	53111030	53112030	
M25	19042800	53111030	53112030	

\* Metric top-entry hoods do not come with a neck

## EPIC® HB 10 high profile hood

Single-entry hood with single lever bolts

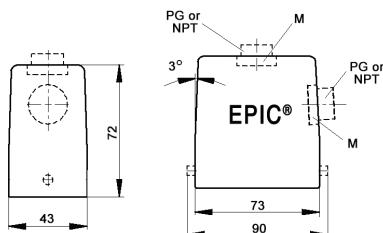
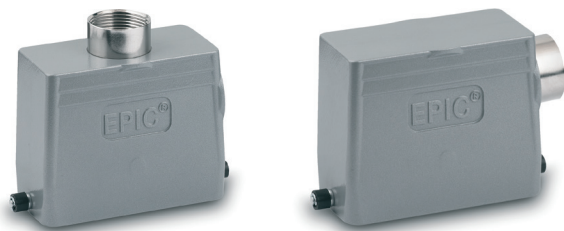

all dimensions are in mm

### Technical data

**IP Protection class:** UL 50E Type 12  
NEMA 4  
IP65

### Complete the installation

 HB dust covers  
page 429

### Approvals



### PG

size	PG hood		SKINTOP® gland	
	part number	plastic	metal	
<b>Top entry</b>				
PG 21	700442	53015050	52015750	
PG 29	700444	53015060	52015760	
<b>Side entry</b>				
PG 21	700542	53015050	52015750	
PG 29	700544	53015060	52015760	

PG hood provided with EPIC® SM/SP gland

### NPT

size	NPT hood		SKINTOP® gland	
	part number	plastic	metal	
<b>Top entry</b>				
3/4"	700442NP	S1134	53112034	
1"	700444NP	S1101	53112044	
<b>Side entry</b>				
3/4"	700542NP	S1134	53112034	
1"	700544NP	S1101	53112044	

NPT hood provided with NPT fitting

### metric

size	Metric hood		SKINTOP® gland	
	part number	plastic	metal	
<b>Top entry*</b>				
M25	79044200	53111030	53112030	
M32	79044400	53111040	53112040	
<b>Side entry</b>				
M25	79054200	53111030	53112030	
M29	79054400	53111040	53112040	

\* Metric hoods do not come with a neck

Recommended SKINTOP® assumes minimal OD variance. Additional configurations are available; please see our SKINTOP® section.  
If not otherwise specified, all values relating to the product are nominal values.  
Photographs are not to scale and are not true representations of the products in question.

# EPIC® HB 10 standard surface mount base

## Surface mount base with single lever

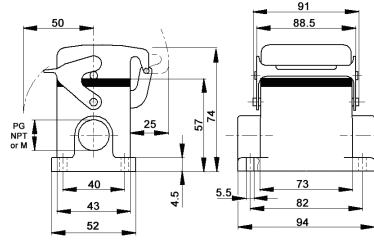
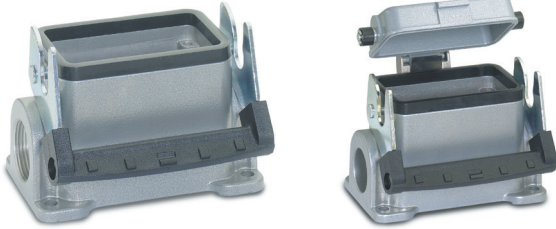

all dimensions are in mm

**Technical data**

**IP Protection class:** UL 50E Type 12  
NEMA 4  
IP65

**Complete the installation**

 HB dust covers  
page 429

**Approvals**

**PG**

size	PG base		Dust cover	SKINTOP® gland	
	part number			plastic	metal
<b>One entry</b>					
16	100349	no	53015040	52015740	
16	100369	yes	53015040	52015740	
21	100347	no	53015050	52015750	
<b>Two entries</b>					
16	100359	no	53015040	52015740	
16	100389	yes	53015040	52015740	

PG base provided with EPIC® SM/SP gland

**NPT**

size	NPT base		Dust cover	SKINTOP® gland	
	part number			plastic	metal
<b>One entry</b>					
½"	100349NP	no	S1112	53112024	
½"	100369NP	yes	S1112	53112024	
¾"	100347NP	no	S1134	53112034	
<b>Two entries</b>					
½"	100359NP	no	S1112	53112024	
½"	100389NP	yes	S1112	53112024	

NPT base provided with NPT fitting

**metric**

size	Metric base		Dust cover	SKINTOP® gland	
	part number			plastic	metal
<b>One entry</b>					
20	19034900	no	53111020	53112020	
20	19036900	yes	53111020	53112020	
25	19034700	no	53111030	53112030	
25	79064600	yes	53111030	53112030	
<b>Two entries</b>					
20	19035900	no	53111020	53112020	
20	19038900	yes	53111020	53112020	
25	79061600	no	53111030	53112030	

# EPIC® HB 10 high profile surface mount base

## Surface mount base with single lever

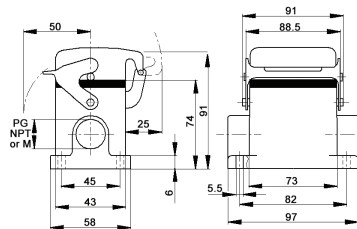
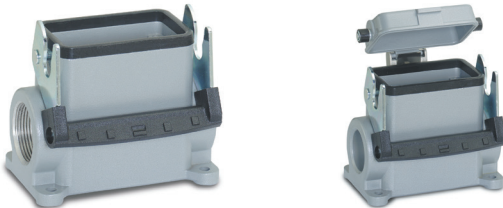

all dimensions are in mm

**Technical data**

**IP Protection class:** UL 50E Type 12  
NEMA 4  
IP65

**Complete the installation**

 HB dust covers  
page 429

**Approvals**

**PG**

size	PG base		Dust cover	SKINTOP® gland	
	part number			plastic	metal
<b>One entry</b>					
21	700602	no	53015050	52015750	
21	700642	yes	53015050	52015750	
29	700604R	no	53015060	52015760	
29	700644	yes	53015050	52015750	
<b>Two entries</b>					
21	700612	no	53015050	52015750	
21	700652	yes	53015050	52015750	
29	700614	no	53015060	52015760	
29	700654	yes	53015060	52015760	

PG base provided with EPIC® SM/SP gland

**NPT**

size	NPT base		Dust cover	SKINTOP® gland	
	part number			plastic	metal
<b>One entry</b>					
¾"	700602NP	no	S1134	53112034	
¾"	700642NP	yes	S1134	53112034	
1"	700604NP	no	S1101	53112044	
1"	700644NP	yes	S1101	53112044	
<b>Two entries</b>					
¾"	700612NP	no	S1134	53112034	
¾"	700652NP	yes	S1134	53112034	
1"	700614NP	no	S1101	53112044	
1"	700654NP	yes	S1101	53112044	

NPT base provided with NPT fitting

**metric**

size	Metric base		Dust cover	SKINTOP® gland	
	part number			plastic	metal
<b>One entry</b>					
25	79060200	no	53111030	53112030	
25	79064200	yes	53111030	53112030	
32	79060400	no	53111040	53112040	
32	79064400	yes	53111040	53112040	
<b>Two entries</b>					
25	79061200	no	53111030	53112030	
25	79065200	yes	53111030	53112030	
32	79061400	no	53111030	53112030	
32	79065400	yes	53111030	53112030	

Photographs are not to scale and are not true representations of the products in question. Recommended SKINTOP® assumes minimal OD variance. Additional configurations are available; please see our SKINTOP® section. If not otherwise specified, all values relating to the product are nominal values.

# EPIC® HB 10 panel mount base

Panel mount base with single lever

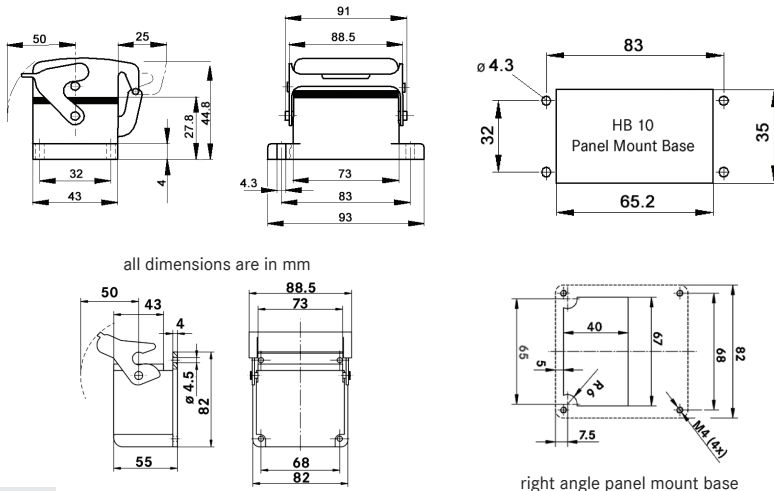
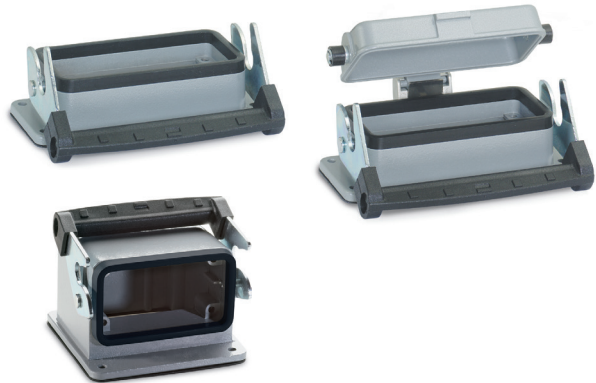

### Technical data

**IP Protection class:** UL 50E Type 12  
NEMA 4  
IP65

### Complete the installation

HB dust covers page 429

### Approvals



Description	Dust cover included	Part number
standard	no	10032900
standard	yes	10033900
right angle	no	44423026

# EPIC® HB 10 cable coupler hood

Cable coupler with single lever



standard profile

high profile

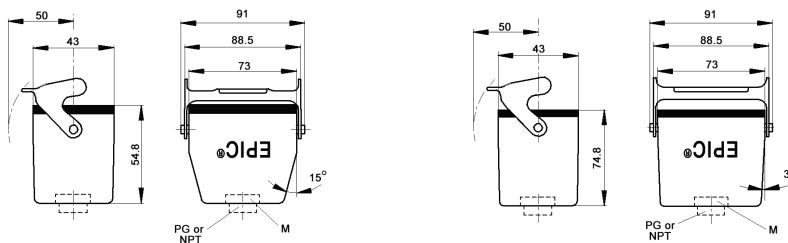

### Technical data

**IP Protection class:** UL 50E Type 12  
NEMA 4  
IP65

### Complete the installation

HB dust covers page 429

### Approvals



## PG

PG coupler size	part number	SKINTOP® gland	
		plastic	metal
<b>Standard profile</b>			
PG 16	100469	53015040	52015740
PG 21	700422	53015050	52015750
<b>High profile</b>			
PG 21	700424	53015050	52015750
PG 29	700426	53015060	52015760

PG coupler provided with EPIC® SM/SP gland

## NPT

NPT coupler size	part number	SKINTOP® gland	
		plastic	metal
<b>Standard profile</b>			
1/2"	100469NP	S 1112	53112024
3/4"	700422NP	S 1134	53112034
<b>High profile</b>			
3/4"	700424NP	S 1134	53112034
1"	700426NP	S 1101	53112044

NPT coupler provided with NPT fitting

## metric

Metric coupler* size	part number	SKINTOP® gland	
		plastic	metal
<b>Standard profile</b>			
M20	19046900	53111020	53112030
M25	79042200	53111030	53112030
<b>High profile</b>			
M25	79042400	53111030	53112030
M32	79042600	53111040	53112040

\* Metric couplers do not come with a neck

Recommended SKINTOP® assumes minimal OD variance. Additional configurations are available; please see our SKINTOP® section. If not otherwise specified, all values relating to the product are nominal values. Photographs are not to scale and are not true representations of the products in question.

## EPIC® HB 10 standard hood

Single-entry hood with double lever bolts

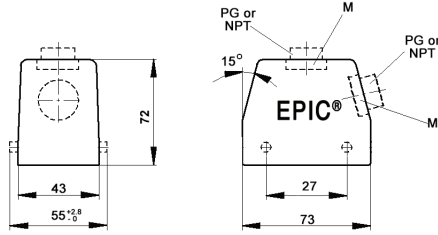
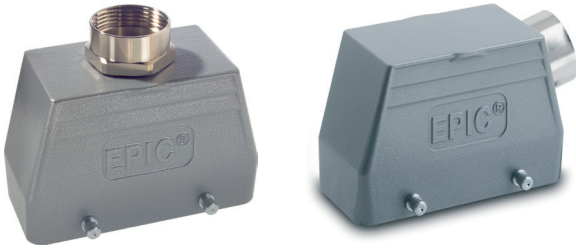

all dimensions are in mm

**Technical data**

**IP Protection class:** UL 50E Type 4, 12 IP65

**Complete the installation**

HB dust covers page 429

**Approvals**

UL US RoHS VDE

**PG**

PG hood		SKINTOP® gland	
size	part number	plastic	metal
<b>Top entry</b>			
PG 16	100400	53015040	52015740
PG 21	100401	53015050	52015750
<b>Side entry</b>			
PG 16	100420	53015040	52015740
PG 21	100421	53015050	52015750

PG hood provided with EPIC® SM/SP gland

**NPT**

NPT hood		SKINTOP® gland	
size	part number	plastic	metal
<b>Top entry</b>			
1/2"	100400NP	S1112	53112024
3/4"	100401NP	S1134	53112034
<b>Side entry</b>			
1/2"	100420NP	S1112	53112024
3/4"	100421NP	S1134	53112034

NPT hood provided with NPT fitting

**metric**

Metric hood		SKINTOP® gland	
size	part number	plastic	metal
<b>Top entry*</b>			
M20	19040000	53111020	53112020
M25	19040100	53111030	53112030
<b>Side entry</b>			
M20	19042000	53111030	53112030
M25	19042100	53111030	53112030

\* Metric top-entry hoods do not come with a neck

## EPIC® HB 10 high profile hood

Single-entry hood with double lever bolts

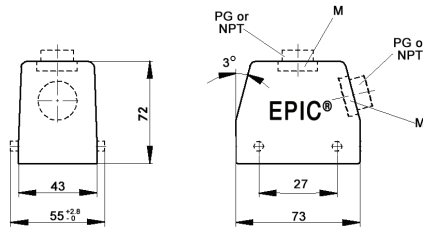
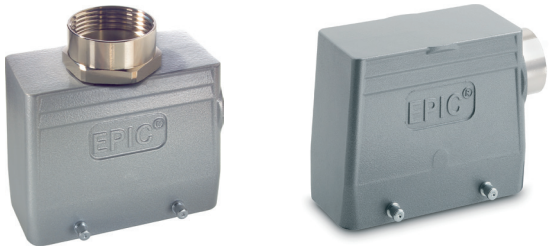

all dimensions are in mm

**Technical data**

**IP Protection class:** UL 50E Type 4, 12 IP65

**Complete the installation**

HB dust covers page 429

**Approvals**

UL US RoHS VDE

**PG**

PG hood		SKINTOP® gland	
size	part number	plastic	metal
<b>Top entry</b>			
PG 21	700504	53015050	52015750
PG 29	700506	53015060	52015760
<b>Side entry</b>			
PG 21	700524	53015050	52015750
PG 29	700526	53015060	52015760

PG hood provided with EPIC® SM/SP gland

**NPT**

NPT hood		SKINTOP® gland	
size	part number	plastic	metal
<b>Top entry</b>			
3/4"	700504NP	S1134	53112034
1"	700506NP	S1101	53112044
<b>Side entry</b>			
3/4"	700524NP	S1134	53112034
1"	700526NP	S1101	53112044

NPT hood provided with NPT fitting

**metric**

Metric hood		SKINTOP® gland	
size	part number	plastic	metal
<b>Top entry*</b>			
M25	79050400	53111030	53112030
M32	79050600	53111040	53112040
<b>Side entry</b>			
M25	79052400	53111030	53112030
M32	79052600	53111040	53112040

\* Metric hoods do not come with a neck

Recommended SKINTOP® assumes minimal OD variance. Additional configurations are available; please see our SKINTOP® section. If not otherwise specified, all values relating to the product are nominal values. Photographs are not to scale and are not true representations of the products in question.

## EPIC® HB 10 standard surface mount base

Surface mount base with double levers

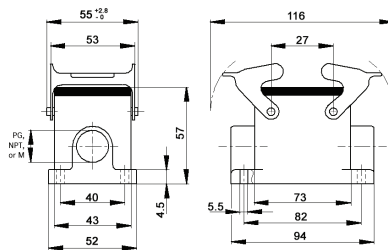
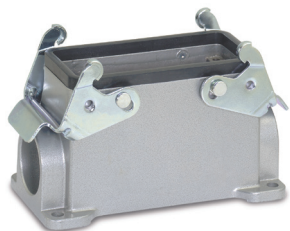

all dimensions are in mm

### Technical data

**IP Protection class:** UL 50E Type 4, 12  
IP65

### Complete the installation



HB dust covers  
page 429

### Approvals



### PG

PG base		SKINTOP® gland	
size	part number	plastic	metal
<b>One entry</b>			
PG 16	100340	53015040	52015740
<b>Two entries</b>			
PG 16	100350	53015040	52015740

PG base provided with EPIC® SM/SP gland

### NPT

NPT base		SKINTOP® gland	
size	part number	plastic	metal
<b>One entry</b>			
½"	100340NP	S 1112	53112024
<b>Two entries</b>			
½"	100350NP	S 1112	53112024

NPT base provided with NPT fitting

### metric

Metric base		SKINTOP® gland	
size	part number	plastic	metal
<b>One entry</b>			
M20	19034000	53111020	53112020
M25	19034100	53111030	53112030
<b>Two entries</b>			
M20	19035000	53111020	53112020
M25	19035100	53111030	53112030

## EPIC® HB 10 high profile surface mount base

Surface mount base with double levers

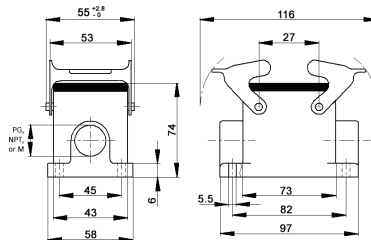
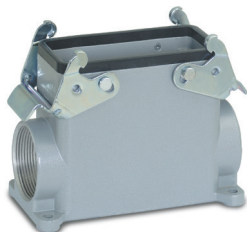

all dimensions are in mm

### Technical data

**IP Protection class:** UL 50E Type 4, 12  
IP65

### Complete the installation



HB dust covers  
page 429

### Approvals



### PG

PG base		SKINTOP® gland	
size	part number	plastic	metal
<b>One entry</b>			
PG 21	700352	53015050	52015750
PG 29	700354	53015060	52015760
<b>Two entries</b>			
PG 21	700362	53015050	52015750
PG 29	700364	53015060	52015760

PG base provided with EPIC® SM/SP gland

### NPT

NPT base		SKINTOP® gland	
size	part number	plastic	metal
<b>One entry</b>			
¾"	700352NP	S 1134	53112034
1"	700354NP	S 1101	53112044
<b>Two entries</b>			
¾"	700362NP	S 1134	53112034
1"	700364NP	S 1101	53112044

NPT base provided with NPT fitting

### metric

Metric base		SKINTOP® gland	
size	part number	plastic	metal
<b>One entry</b>			
M21	79035200	53111030	53112030
M32	79035400	53111040	53112040
<b>Two entries</b>			
M21	79036200	53111030	53112030
M32	79036400	53111040	53112040

Recommended SKINTOP® assumes minimal OD variance. Additional configurations are available; please see our SKINTOP® section.  
If not otherwise specified, all values relating to the product are nominal values.  
Photographs are not to scale and are not true representations of the products in question.

# EPIC® HB 10 panel mount base

Panel mount base with double levers

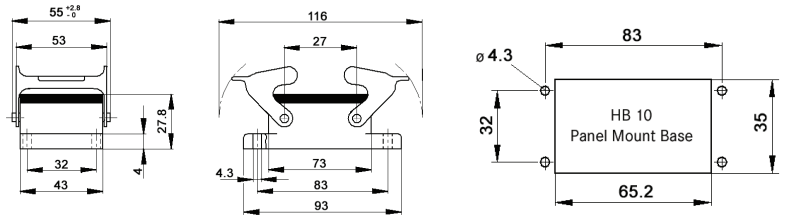

all dimensions are in mm

**Technical data**

**IP Protection class:** UL 50E Type 4, 12 IP65

**Complete the installation**

HB dust covers page 429

**Approvals**

UL US RoHS

Dust cover included	Part number
no	100320C0

# EPIC® HB 10 cable coupler hood

Cable coupler with double levers



standard profile

high profile

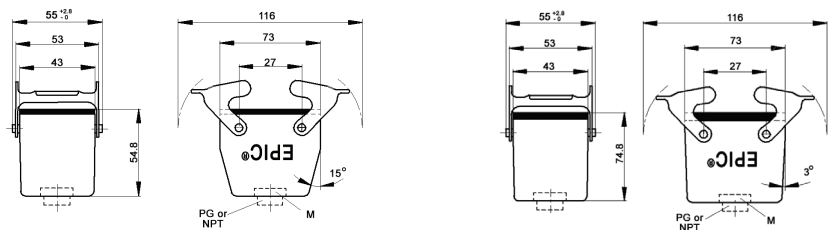

all dimensions are in mm

**Technical data**

**IP Protection class:** UL 50E Type 4, 12 IP65

**Complete the installation**

HB dust covers page 429

**Approvals**

UL US RoHS DE

**PG**

PG coupler size	part number	SKINTOP® gland	
		plastic	metal
<b>Standard profile</b>			
PG 16	100460	53015040	52015740
PG 21	700402	53015050	52015750
<b>High profile</b>			
PG 21	700404R	53015050	52015750
PG 29	700406	53015060	52015760

PG coupler provided with EPIC® SM/SP gland

**NPT**

NPT coupler size	part number	SKINTOP® gland	
		plastic	metal
<b>Standard profile</b>			
1/2"	100460NP	S1112	53112024
3/4"	700402NP	S1134	53112034
<b>High profile</b>			
3/4"	700404NP	S1134	53112034
1"	700406NP	S1101	53112044

NPT coupler provided with NPT fitting

**metric**

Metric coupler* size	part number	SKINTOP® gland	
		plastic	metal
<b>Standard profile</b>			
M20	19046000	53111020	53112030
M25	79040200	53111030	53112030
<b>High profile</b>			
M25	79040400	53111030	53112030
M32	79040600	53111040	53112040

\* Metric couplers do not come with a neck

Recommended SKINTOP® assumes minimal OD variance. Additional configurations are available; please see our SKINTOP® section. If not otherwise specified, all values relating to the product are nominal values. Photographs are not to scale and are not true representations of the products in question.