

REV.	DESCRIPTION	DATE
A	RELEASE	2011/4/15

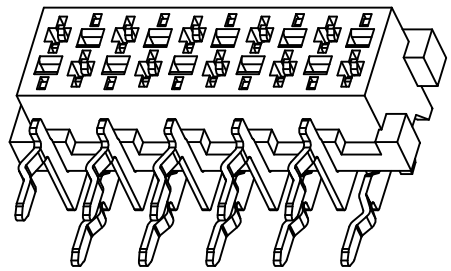
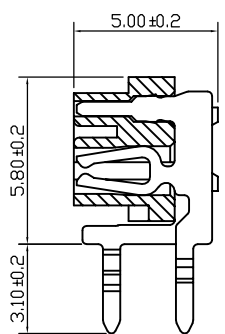
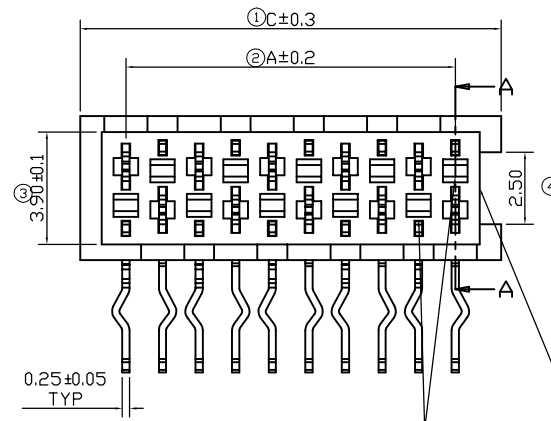

- Specifications :
- Voltage rating: 500V AC / DC
 - Current rating: 1A AC / DC
 - Withstanding voltage: 1000V AC/minute
 - Temperature range: -40° C~+105° C
 - Insulation resistance: ≥1000MΩ
 - Contact resistance: ≤20mΩ
 - After environmental testing : ≤30mΩ

RoHS

REFERENCE MATING INTERFACE PATTERN-
1.27 STAGGERED PITCH x 1.5 ROW-DISTANCE.

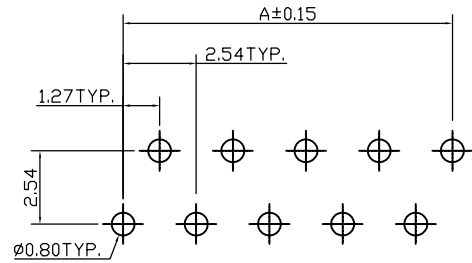
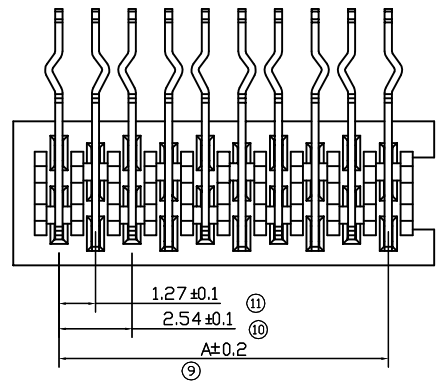
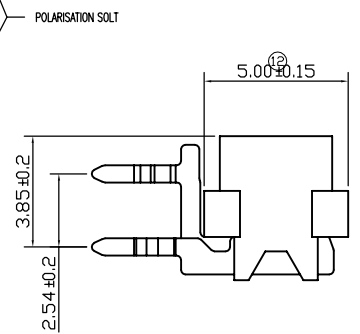
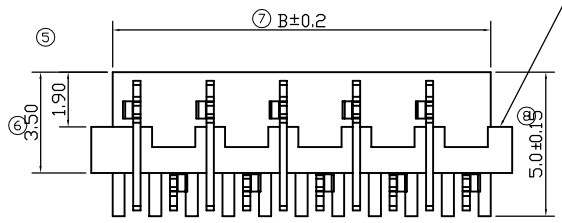

Recommended P.C. Board Layout

PARTNUMBER	NUMBER OF POSITIONS	DIMENSION			Q'ty /Tube
		A	B	C	
3521-04-0200-99	04	3.81	5.50	6.99	82
3521-06-0200-99	06	6.35	8.04	9.53	60
3521-08-0200-99	08	8.89	10.58	12.07	48
3521-10-0200-99	10	11.43	13.12	14.61	39
3521-12-0200-99	12	13.97	15.66	17.15	33
3521-14-0200-99	14	16.51	18.20	19.69	29
3521-16-0200-99	16	19.05	20.74	22.23	26
3521-18-0200-99	18	21.59	23.28	24.77	23
3521-20-0200-99	20	24.13	25.82	27.31	21
3521-22-0200-99	22	26.67	28.36	29.85	19
3521-24-0200-99	24	29.21	30.90	32.39	17
3521-26-0200-99	26	31.75	33.44	34.93	16

UNLESS TOLERANCE		DRAW BY	zhan
GENERAL	ANGLE	DESIGN BY	袁刚
X. ± 0.38	X.' ± 3.0°	CHECK BY	
.X ± 0.30	.X' ± 2.0°	APPROVE BY	
.XX ± 0.25	.XX' ± 1.0°	SCALE	SHEET
.XXX ± 0.10	.XXX' ± 0.5°	1:1	1/1
		UNIT	MM

CnC Tech,LLC

ITEM : Female-on-Board Connector
Side Entry

DRW NO: 3521-XX-0200-99 REV: A

ITEM NO.	COMPONENT DESCRIPTION	MATERIAL	FINISH / COLOR
2	FEMALE HOUSING	PA9T UL 94V-0	RED
1	FEMALE CONTACT	Bronze	TIN OVER NICKEL