

## 309CMQ135/309CMQ150 SCHOTTKY RECTIFIER

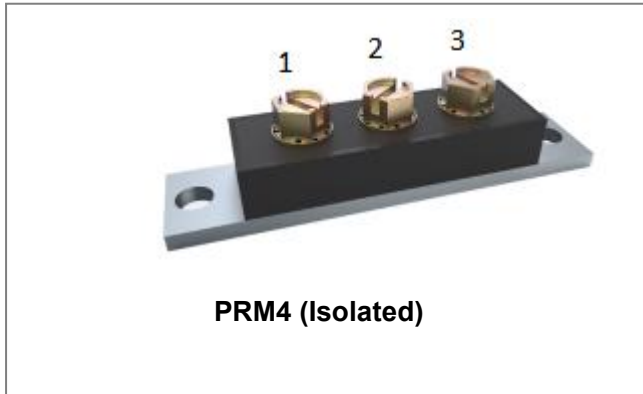

### Features

- 175°C T<sub>J</sub> operation
- Center tap module
- High purity, high temperature epoxy encapsulation for enhanced mechanical strength and moisture resistance
- Low forward voltage drop
- High frequency operation
- Guard ring for enhanced ruggedness and long term reliability
- Base plate: Nickel plated; Terminals: Nickel plated
- This is a Pb – Free Device
- All SMC parts are traceable to the wafer lot
- Additional testing can be offered upon request

### Circuit Diagram

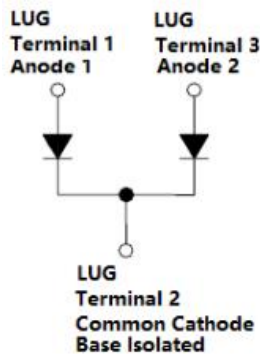

### Applications

- High current switching power supply
- Plating power supply
- Free-Wheeling diodes
- Reverse battery protection
- Converters
- UPS System
- Welding

### Maximum Ratings(limiting values, at 25 °C unless otherwise specified)

Characteristics	Symbol	Condition	Max.		Units
			135	309CMQ135	
Peak Repetitive Reverse Voltage	V <sub>RRM</sub>	-	135	309CMQ135	V
Working Peak Reverse Voltage	V <sub>RWM</sub>		150	309CMQ150	
DC Blocking Voltage	V <sub>R</sub>				
Average Rectified Forward Current	I <sub>F(AV)</sub>	50% duty cycle @T <sub>c</sub> =110°C, rectangular wave form	150(Per Leg)		A
			300(Per Device)		
Peak One Cycle Non-Repetitive Surge Current (Per Leg)	I <sub>FSM</sub>	8.3 ms, half Sine pulse	1440		A

**Electrical Characteristics:**

Characteristics	Symbol	Condition	Typ.	Max.	Units
Forward Voltage Drop(Per Leg)*	V <sub>F1</sub>	@ 150A, Pulse, T <sub>J</sub> = 25 °C @ 300A, Pulse, T <sub>J</sub> = 25 °C	0.83 0.93	1.03 1.22	V
	V <sub>F2</sub>	@ 150A, Pulse, T <sub>J</sub> = 125 °C @ 300A, Pulse, T <sub>J</sub> = 125 °C	0.72 0.79	0.76 0.82	V
Reverse Current(Per Leg)*	I <sub>R1</sub>	@V <sub>R</sub> = rated V <sub>R</sub> , T <sub>J</sub> = 25 °C	0.06	3	mA
	I <sub>R2</sub>	@V <sub>R</sub> = rated V <sub>R</sub> , T <sub>J</sub> = 125 °C	3.40	45	mA
Junction Capacitance(Per leg)	C <sub>T</sub>	@V <sub>R</sub> = 5V, T <sub>C</sub> = 25 °C f <sub>sig</sub> = 1MHz	2990	4000	pF
Voltage Rate of Change	dv/dt	-	-	10,000	V/μs

\* Pulse width < 300 μs, duty cycle < 2%

**Thermal-Mechanical Specifications:**

Characteristics	Symbol	Condition	Specification	Units	
Junction Temperature	T <sub>J</sub>	-	-55 to +175	°C	
Storage Temperature	T <sub>stg</sub>	-	-55 to +175	°C	
Typical Thermal Resistance Junction to Case(Per leg)	R <sub>θJC</sub>	DC operation	0.30	°C/W	
Typical Thermal Resistance Junction to Case(Per package)	R <sub>θJC</sub>	DC operation	0.15	°C/W	
Typical Thermal Resistance, case to Heat Sink	R <sub>θcs</sub>	Mounting surface, smooth and greased	0.05	°C/W	
Mounting Torque	T <sub>M</sub>	-	Mounting Torque	24(min) 35(max)	Kg-cm
			Terminal Torque	35(min) 46(max)	
Approximate Weight	wt	-	110	g	
Case Style	PRM4 Isolated				

**Ratings and Characteristics Curves**

Figure 1  
Typical Forward Characteristics

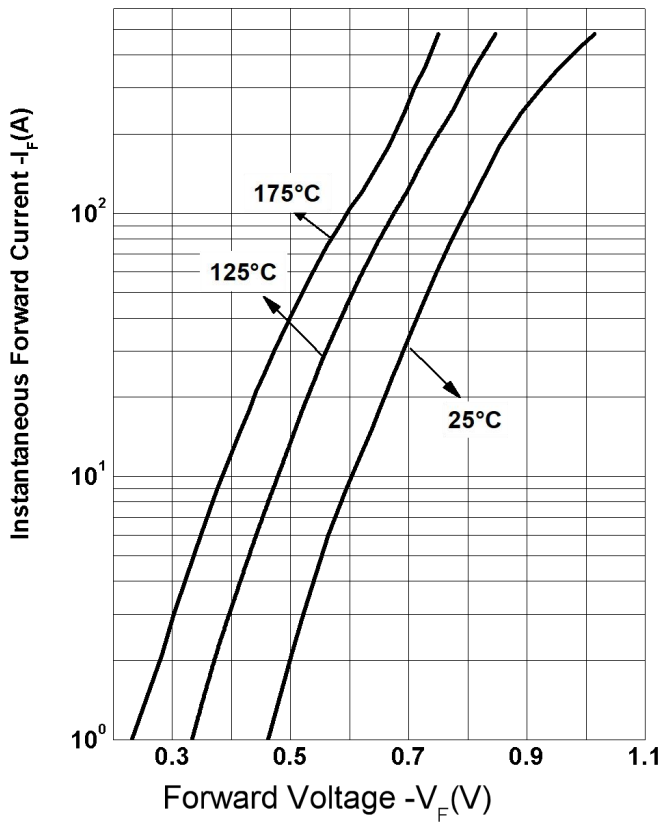

Figure 2  
Typical Reverse Characteristics

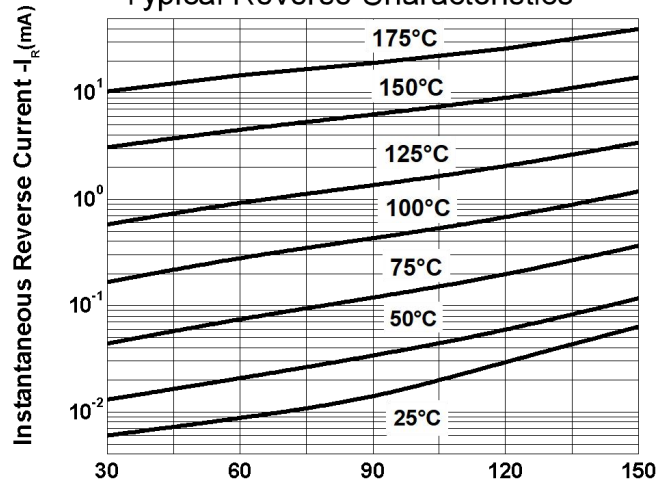
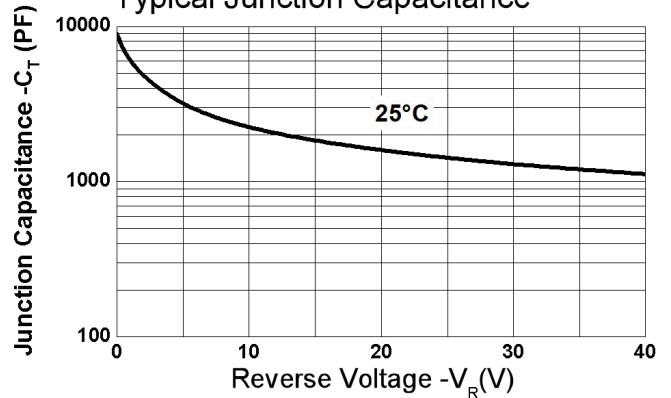
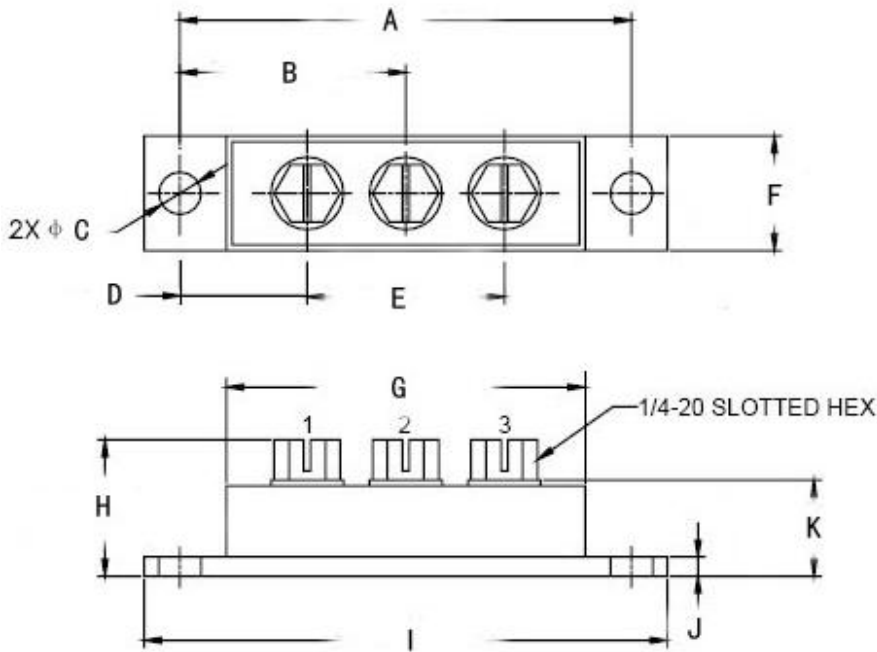

Figure 3  
Reverse Voltage  $-V_R$  (V)  
Typical Junction Capacitance



**Mechanical Dimensions PRM4 Isolated (Millimeters/Inches)**



SYMBOL	Millimeters		Inches	
	Min.	Max.	Min.	Max.
A	78.74	81.28	3.100	3.200
B	37.47	42.55	1.475	1.675
C	6.89	7.69	0.271	0.303
D	19.51	24.59	0.768	0.968
E	33.02	38.10	1.300	1.500
F	17.78	20.32	0.700	0.800
G	60.96	64.77	2.400	2.550
H	17.56	23.55	0.691	0.927
I	90.17	92.71	3.550	3.650
J	3.02	3.68	0.119	0.145
K	15.75	17.50	0.620	0.689

**Marking Diagram**

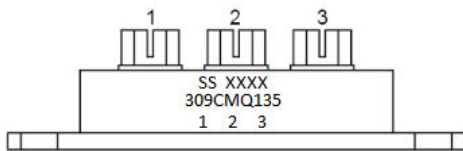

Where XXXX is YYWW

309CMQ135 = Part name  
SS = SS  
YY = Year  
WW = Week

**Cautions:** Molding resin  
Epoxy resin UL:94V-0

**Ordering Information**

Device	Package	Shipping
309CMQ SERIES	PRM4 Isolated (Pb-Free)	9 pcs/box

**DISCLAIMER:**

1- The information given herein, including the specifications and dimensions, is subject to change without prior notice to improve product characteristics. Before ordering, purchasers are advised to contact the SMC Diode Solutions sales department for the latest version of the datasheet(s).

2- In cases where extremely high reliability is required (such as use in nuclear power control, aerospace and aviation, traffic equipment, medical equipment, and safety equipment), safety should be ensured by using semiconductor devices that feature assured safety or by means of users' fail-safe precautions or other arrangement.

3- In no event shall SMC Diode Solutions be liable for any damages that may result from an accident or any other cause during operation of the user's units according to the datasheet(s). SMC Diode Solution assumes no responsibility for any intellectual property claims or any other problems that may result from applications of information, products or circuits described in the datasheets.

4- In no event shall SMC Diode Solutions be liable for any failure in a semiconductor device or any secondary damage resulting from use at a value exceeding the absolute maximum rating.

5- No license is granted by the datasheet(s) under any patents or other rights of any third party or SMC Diode Solutions.

6- The datasheet(s) may not be reproduced or duplicated, in any form, in whole or part, without the expressed written permission of SMC Diode Solutions.

7- The products (technologies) described in the datasheet(s) are not to be provided to any party whose purpose in their application will hinder maintenance of international peace and safety nor are they to be applied to that purpose by their direct purchasers or any third party. When exporting these products (technologies), the necessary procedures are to be taken in accordance with related laws and regulations..