

2N6667, 2N6668

Darlington Silicon Power Transistors

Designed for general-purpose amplifier and low speed switching applications.

- High DC Current Gain –
 $h_{FE} = 3500$ (Typ) @ $I_C = 4.0$ Adc
- Collector–Emitter Sustaining Voltage – @ 200 mAdc
 $V_{CE(sus)} = 60$ Vdc (Min) – 2N6667
 $= 80$ Vdc (Min) – 2N6668
- Low Collector–Emitter Saturation Voltage –
 $V_{CE(sat)} = 2.0$ Vdc (Max) @ $I_C = 5.0$ Adc
- Monolithic Construction with Built–In Base–Emitter Shunt Resistors
- TO–220AB Compact Package
- Complementary to 2N6387, 2N6388
- These Devices are Pb–Free and are RoHS Compliant*

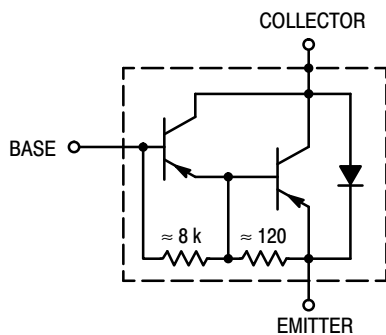

Figure 1. Darlington Schematic



ON Semiconductor®

www.onsemi.com

**PNP SILICON
DARLINGTON
POWER TRANSISTORS
10 A, 60–80 V, 65 W**

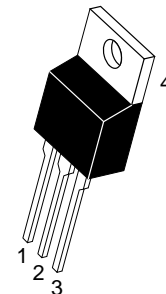

TO-220
CASE 221A
STYLE 1

MARKING DIAGRAM



x = 7 or 8
A = Assembly Location
Y = Year
WW = Work Week
G = Pb–Free Package

ORDERING INFORMATION

Device	Package	Shipping
2N6667G	TO–220 (Pb–Free)	50 Units/Rail
2N6668G	TO–220 (Pb–Free)	50 Units/Rail

*For additional information on our Pb–Free strategy and soldering details, please download the ON Semiconductor Soldering and Mounting Techniques Reference Manual, SOLDERRM/D.

2N6667, 2N6668

MAXIMUM RATINGS (Note 1)

Rating	Symbol	2N6667	2N6668	Unit
Collector–Emitter Voltage	V_{CEO}	60	80	Vdc
Collector–Base Voltage	V_{CB}	60	80	Vdc
Emitter–Base Voltage	V_{EB}	5.0		Vdc
Collector Current – Continuous – Peak	I_C	10 15		Adc
Base Current	I_B	250		mAdc
Total Device Dissipation @ $T_C = 25^\circ\text{C}$ Derate above 25°C	P_D	65 0.52		W W/ $^\circ\text{C}$
Total Device Dissipation @ $T_A = 25^\circ\text{C}$ Derate above 25°C	P_D	2.0 0.016		W W/ $^\circ\text{C}$
Operating and Storage Junction Temperature Range	T_J, T_{stg}	–65 to +150		$^\circ\text{C}$

Stresses exceeding those listed in the Maximum Ratings table may damage the device. If any of these limits are exceeded, device functionality should not be assumed, damage may occur and reliability may be affected.

THERMAL CHARACTERISTICS

Characteristic	Symbol	Max	Unit
Thermal Resistance, Junction to Case	$R_{\theta JC}$	1.92	$^\circ\text{C/W}$
Thermal Resistance, Junction to Ambient	$R_{\theta JA}$	62.5	$^\circ\text{C/W}$

ELECTRICAL CHARACTERISTICS (Note 1) ($T_C = 25^\circ\text{C}$ unless otherwise noted)

Characteristic	Symbol	Min	Max	Unit
----------------	--------	-----	-----	------

OFF CHARACTERISTICS

Collector–Emitter Sustaining Voltage (Note 2) ($I_C = 200\text{ mAdc}, I_B = 0$)	2N6667 2N6668	$V_{CEO(sus)}$	60 80	– –	Vdc
Collector Cutoff Current ($V_{CE} = 60\text{ Vdc}, I_B = 0$) ($V_{CE} = 80\text{ Vdc}, I_B = 0$)	2N6667 2N6668	I_{CEO}	– –	1.0 1.0	mAdc
Collector Cutoff Current ($V_{CE} = 60\text{ Vdc}, V_{EB(off)} = 1.5\text{ Vdc}$) ($V_{CE} = 80\text{ Vdc}, V_{EB(off)} = 1.5\text{ Vdc}$) ($V_{CE} = 60\text{ Vdc}, V_{EB(off)} = 1.5\text{ Vdc}, T_C = 125^\circ\text{C}$) ($V_{CE} = 80\text{ Vdc}, V_{EB(off)} = 1.5\text{ Vdc}, T_C = 125^\circ\text{C}$)	2N6667 2N6668 2N6667 2N6668	I_{CEX}	– – – –	300 300 3.0 3.0	μAdc mAdc
Emitter Cutoff Current ($V_{BE} = 5.0\text{ Vdc}, I_C = 0$)		I_{EBO}	–	5.0	mAdc

ON CHARACTERISTICS (Note 1)

DC Current Gain ($I_C = 5.0\text{ Adc}, V_{CE} = 3.0\text{ Vdc}$) ($I_C = 10\text{ Adc}, V_{CE} = 3.0\text{ Vdc}$)		h_{FE}	1000 100	20000 –	–
Collector–Emitter Saturation Voltage ($I_C = 5.0\text{ Adc}, I_B = 0.01\text{ Adc}$) ($I_C = 10\text{ Adc}, I_B = 0.1\text{ Adc}$)		$V_{CE(sat)}$	– –	2.0 3.0	Vdc
Base–Emitter Saturation Voltage ($I_C = 5.0\text{ Adc}, I_B = 0.01\text{ Adc}$) ($I_C = 10\text{ Adc}, I_B = 0.1\text{ Adc}$)		$V_{BE(sat)}$	– –	2.8 4.5	Vdc

DYNAMIC CHARACTERISTICS

Current Gain – Bandwidth Product ($I_C = 1.0\text{ Adc}, V_{CE} = 5.0\text{ Vdc}, f_{test} = 1.0\text{ MHz}$)		$ h_{fe} $	20	–	–
Output Capacitance ($V_{CB} = 10\text{ Vdc}, I_E = 0, f = 1.0\text{ MHz}$)		C_{ob}	–	200	pF
Small–Signal Current Gain ($I_C = 1.0\text{ Adc}, V_{CE} = 5.0\text{ Vdc}, f = 1.0\text{ kHz}$)		h_{fe}	1000	–	–

Product parametric performance is indicated in the Electrical Characteristics for the listed test conditions, unless otherwise noted. Product performance may not be indicated by the Electrical Characteristics if operated under different conditions.

1. Indicates JEDEC Registered Data.
2. Pulse Test: Pulse Width $\leq 300\ \mu\text{s}$, Duty Cycle $\leq 2\%$.

2N6667, 2N6668

R_B & R_C VARIED TO OBTAIN DESIRED CURRENT LEVELS

D_1 , MUST BE FAST RECOVERY TYPES e.g.,

1N5825 USED ABOVE $I_B \approx 100$ mA

MSD6100 USED BELOW $I_B \approx 100$ mA

FOR t_d AND t_r , D_1 IS DISCONNECTED AND $V_2 = 0$

$t_r, t_f \leq 10$ ns

DUTY CYCLE = 1.0%

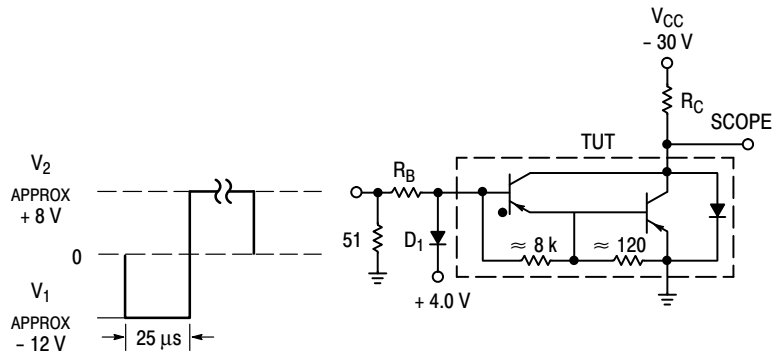

Figure 2. Switching Times Test Circuit

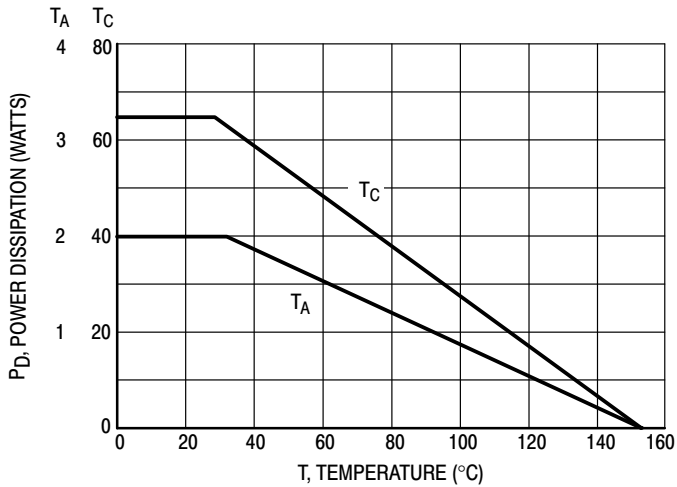

Figure 3. Power Derating

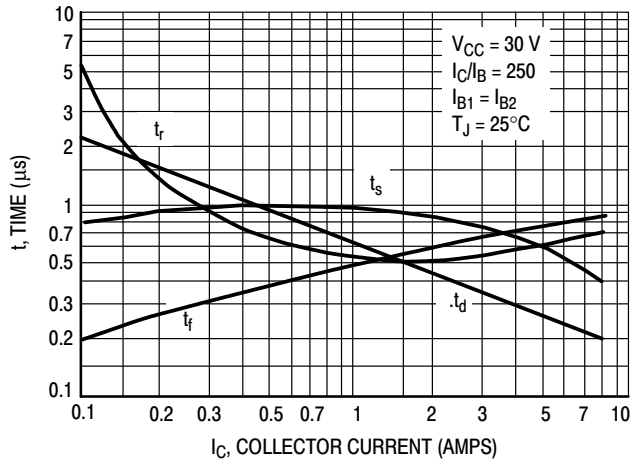

Figure 4. Typical Switching Times

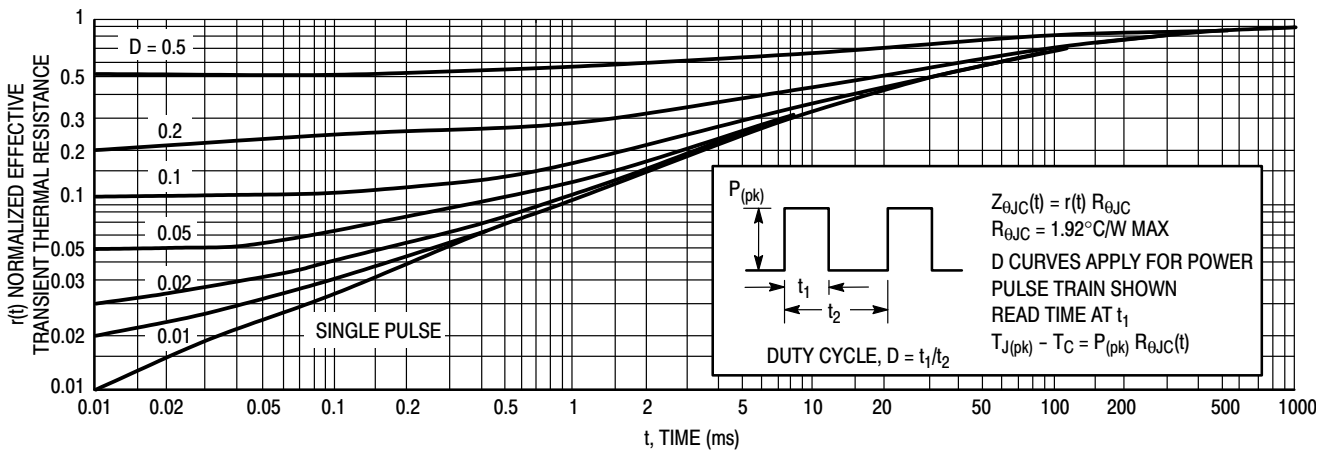

Figure 5. Thermal Response

2N6667, 2N6668

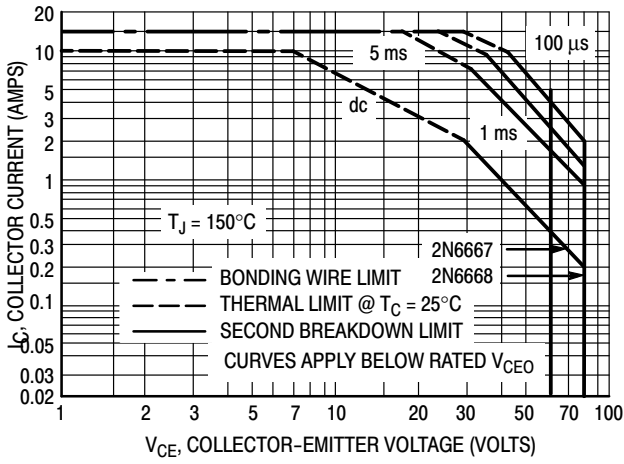

Figure 6. Maximum Safe Operating Area

There are two limitations on the power handling ability of a transistor: average junction temperature and second breakdown. Safe operating area curves indicate $I_C - V_{CE}$ limits of the transistor that must be observed for reliable operation; i.e., the transistor must not be subjected to greater dissipation than the curves indicate.

The data of Figure 6 is based on $T_{J(pk)} = 150^\circ\text{C}$; T_C is variable depending on conditions. Second breakdown pulse limits are valid for duty cycles to 10% provided $T_{J(pk)} < 150^\circ\text{C}$. $T_{J(pk)}$ may be calculated from the data in Figure 5. At high case temperatures, thermal limitations will reduce the power that can be handled to values less than the limitations imposed by second breakdown.

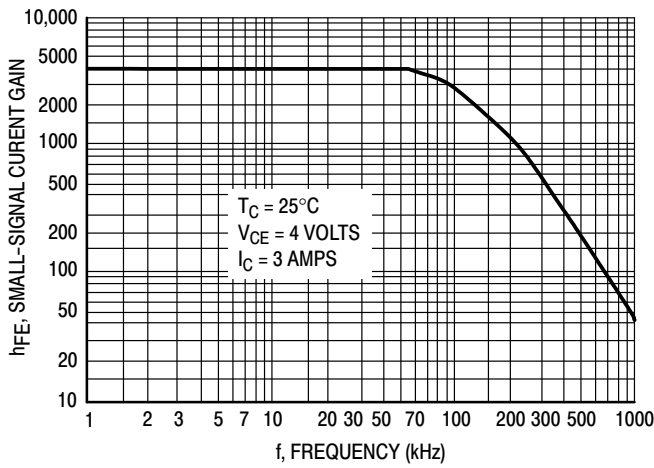

Figure 7. Typical Small-Signal Current Gain

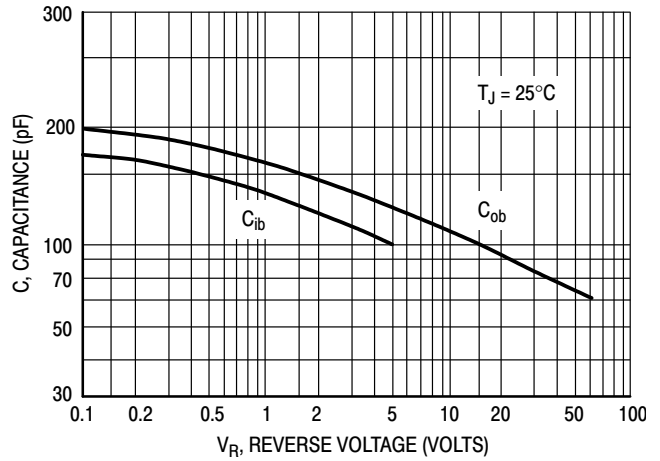

Figure 8. Typical Capacitance

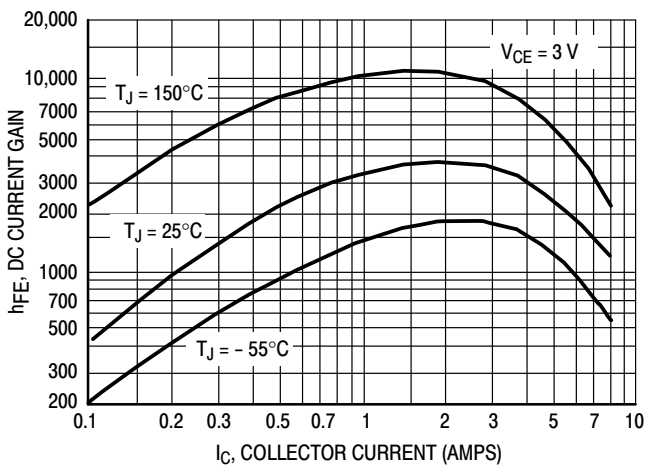

Figure 9. Typical DC Current Gain

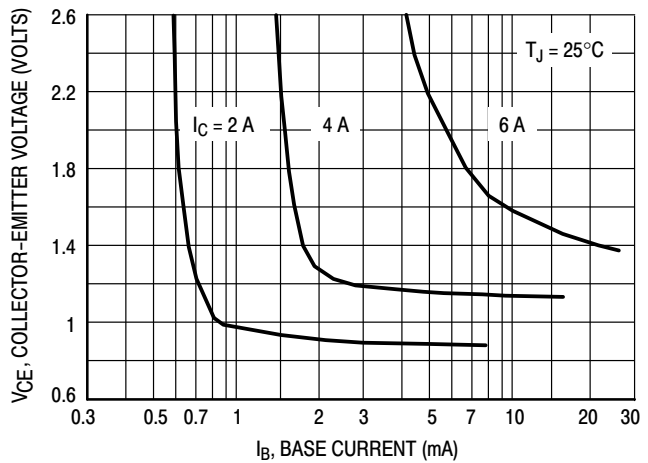

Figure 10. Typical Collector Saturation Region

2N6667, 2N6668

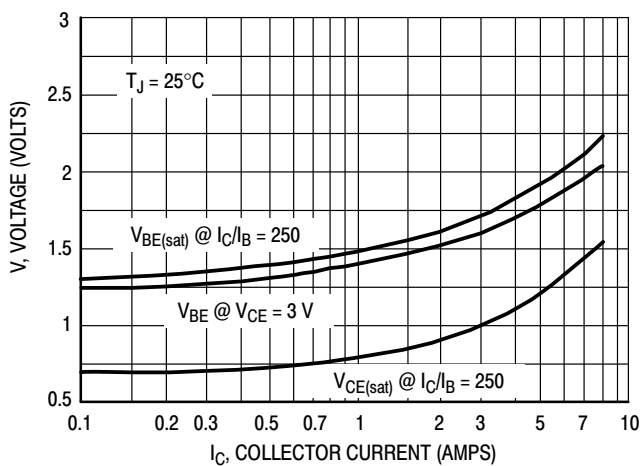

Figure 11. Typical "On" Voltages

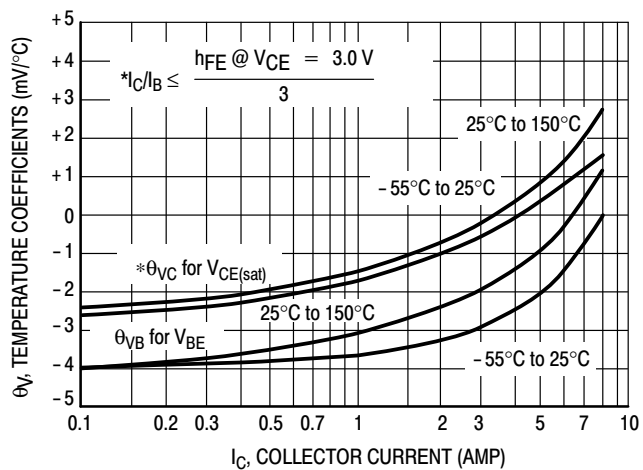

Figure 12. Typical Temperature Coefficients

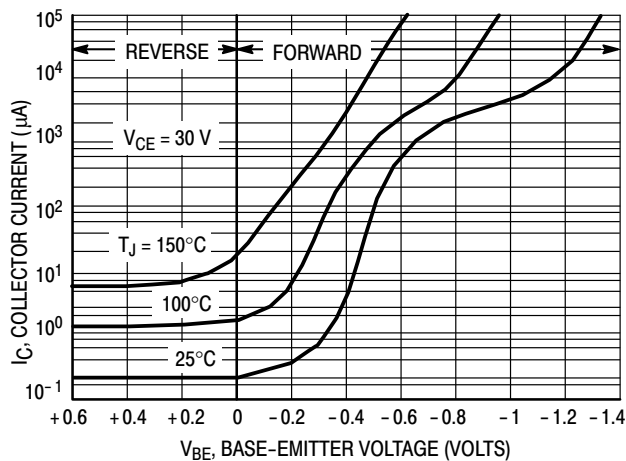

Figure 13. Typical Collector Cut-Off Region

onsemi, **Onsemi**, and other names, marks, and brands are registered and/or common law trademarks of Semiconductor Components Industries, LLC dba "**onsemi**" or its affiliates and/or subsidiaries in the United States and/or other countries. **onsemi** owns the rights to a number of patents, trademarks, copyrights, trade secrets, and other intellectual property. A listing of **onsemi**'s product/patent coverage may be accessed at www.onsemi.com/site/pdf/Patent-Marking.pdf. **onsemi** reserves the right to make changes at any time to any products or information herein, without notice. The information herein is provided "as-is" and **onsemi** makes no warranty, representation or guarantee regarding the accuracy of the information, product features, availability, functionality, or suitability of its products for any particular purpose, nor does **onsemi** assume any liability arising out of the application or use of any product or circuit, and specifically disclaims any and all liability, including without limitation special, consequential or incidental damages. Buyer is responsible for its products and applications using **onsemi** products, including compliance with all laws, regulations and safety requirements or standards, regardless of any support or applications information provided by **onsemi**. "Typical" parameters which may be provided in **onsemi** data sheets and/or specifications can and do vary in different applications and actual performance may vary over time. All operating parameters, including "Typicals" must be validated for each customer application by customer's technical experts. **onsemi** does not convey any license under any of its intellectual property rights nor the rights of others. **onsemi** products are not designed, intended, or authorized for use as a critical component in life support systems or any FDA Class 3 medical devices or medical devices with a same or similar classification in a foreign jurisdiction or any devices intended for implantation in the human body. Should Buyer purchase or use **onsemi** products for any such unintended or unauthorized application, Buyer shall indemnify and hold **onsemi** and its officers, employees, subsidiaries, affiliates, and distributors harmless against all claims, costs, damages, and expenses, and reasonable attorney fees arising out of, directly or indirectly, any claim of personal injury or death associated with such unintended or unauthorized use, even if such claim alleges that **onsemi** was negligent regarding the design or manufacture of the part. **onsemi** is an Equal Opportunity/Affirmative Action Employer. This literature is subject to all applicable copyright laws and is not for resale in any manner.

ADDITIONAL INFORMATION

TECHNICAL PUBLICATIONS:

Technical Library: www.onsemi.com/design/resources/technical-documentation
onsemi Website: www.onsemi.com

ONLINE SUPPORT: www.onsemi.com/support

For additional information, please contact your local Sales Representative at www.onsemi.com/support/sales