

2J6C86MGFa

2× 5GNR MIMO, 2× 2.4/5.0/6.0 GHz ISM MIMO and GNSS
Magnetic Mount

Key Features

Cable 1-2: 5GNR

- 617-960 MHz
- 1427-2690 MHz
- 3300-5000 MHz
- 5150-5925 MHz

Cable 3-4: 2.4/5.0/6.0 GHz ISM

- 2410-2490 MHz
- 4920-7125 MHz

Cable 5: GPS/GLONASS/QZSS/Galileo

- 1575-1606 MHz

Magnetic Mount

High Performance

Ground Plane Independent

Customizable Cable and Connector

Dimensions: 193 × 76.5 × 56.1 mm

Certificates: IP67, IP69

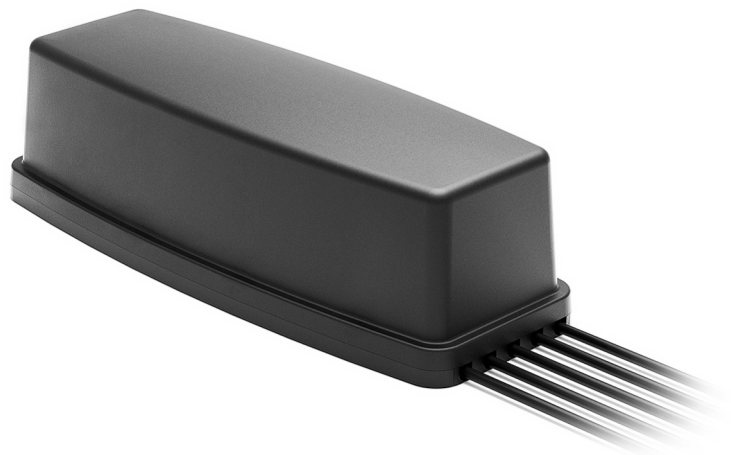

1. Antenna and electrical specifications

Cable 1

| Parameters | 5GNR Antenna | | | |
|----------------------|---|---|---------------------------------|----------------------|
| Technologies | 5G, 4G, 3G and 2G | | | |
| Standards | 5GNR/4GLTE/FirstNet/CBRS/LPWA/CAT-X/CAT-Mx/CAT-NBx/NB-IoT/3G/2G | | | |
| Frequency (MHz) | 617-960 | 1427-2690 | 3300-5000 | 5150-5925 |
| Band (MHz) | 600, 700, 850, 900 | 1500, 1600, 1700, 1800, 1900, 2000, 2100, 2300, 2500, 2600 | 3300, 3500, 3600, 3700, 4500 | 5200, 5500, 5800 |
| 5GNR Bands | n5, n8, 12, n20, n28, n71, n81, n82, n83, | n1, n2, n3, n7, n25, n34, n38, n39, n40, n41, n50, n51, n66, n70, n74, n75, n76, n80, n84, n86 | n77, n78, n79 | |
| 4GLTE Bands | B5, B6, B8, B12, B13, B14, B17, B18, B19, B20, B26, B27, B28, B29, B44, B67, B68, B71, B85 | B1, B2, B3, B4, B7, B9, B10, B11, B21, B23, B24, B25, B30, B32, B33, B34, B35, B36, B37, B38, B39, B40, B41, B45, B50, B51, B65, B66, B69, B70, B74, B75, B76 | B22, B42, B43, B48, B49, B52 | B46, B47, B252, B255 |
| 3GCELL Bands | B5, B6, B8, B12, B13, B14, B19, B20, B26 | B1, B2, B3, B4, B7, B9, B10, B11, B21, B25, B32, B33, B34, B35, B36, B37, B38, B39, B40 | B22 | |
| 2GCELL Bands | 710, 750, 810T, 850, 900P, 900E, 900R | 1800DCS, 1900PCS | | |
| CDMACELL Bands | BC0, BC2, BC3, BC7, BC9, BC10, BC12, BC18, BC19 | BC1, BC4, BC6, BC8, BC13, BC14, BC15, BC16, BC20, BC21 | | |
| Return Loss (dB) | ~-10.4 | ~-13.4 | ~-14.1 | ~-6.8 |
| VSWR | ~2.1:1 | ~1.7:1 | ~1.7:1 | ~2.8:1 |
| Efficiency (%) | ~45.0 | ~58.2 | ~53.1 | ~39.9 |
| Peak Gain (dBi) | ~3.6 | ~5.1 | ~5.2 | ~2.7 |
| Average Gain (dB) | ~-3.5 | ~-2.4 | ~-2.8 | ~-4.0 |
| Impedance (Ohm) | 50 | | | |
| Polarisation | Linear | | | |
| Radiation Pattern | Omni-Directional | | | |
| Max. Input Power (W) | 25 | | | |
| Connector Type | SMA-Male Standard (Other Connectors Available) | | | |
| Cable Length | 300 cm Standard (Any Cable Length Available) | | | |
| Cable Type | LL195 Standard (Other Cables Available) | | | |

Cable 2

| Parameters | 5GNR Antenna | | | |
|-----------------------------|---|---|---------------------------------|----------------------|
| Technologies | 5G, 4G, 3G and 2G | | | |
| Standards | 5GNR/4GLTE/FirstNet/CBRS/LPWA/CAT-X/CAT-Mx/CAT-NBx/NB-IoT/3G/2G | | | |
| Frequency (MHz) | 617-960 | 1427-2690 | 3300-5000 | 5150-5925 |
| Band (MHz) | 600, 700, 850, 900 | 1500, 1600, 1700, 1800, 1900, 2000, 2100, 2300, 2500, 2600 | 3300, 3500, 3600, 3700, 4500 | 5200, 5500, 5800 |
| 5GNR Bands | n5, n8 ,12, n20, n28, n71, n81, n82, n83, | n1, n2, n3, n7, n25, n34, n38, n39, n40, n41, n50, n51, n66, n70, n74, n75, n76, n80, n84, n86 | n77, n78, n79 | |
| 4GLTE Bands | B5, B6, B8, B12, B13, B14, B17, B18, B19, B20, B26, B27, B28, B29, B44, B67, B68, B71, B85 | B1, B2, B3, B4, B7, B9, B10, B11, B21, B23, B24, B25, B30, B32, B33, B34, B35, B36, B37, B38, B39, B40, B41, B45, B50, B51, B65, B66, B69, B70, B74, B75, B76 | B22, B42, B43, B48, B49, B52 | B46, B47, B252, B255 |
| 3GCELL Bands | B5, B6, B8, B12, B13, B14, B19, B20, B26 | B1, B2, B3, B4, B7, B9, B10, B11, B21, B25, B32, B33, B34, B35, B36, B37, B38, B39, B40 | B22 | |
| 2GCELL Bands | 710, 750, 810T, 850, 900P, 900E, 900R | 1800DCS, 1900PCS | | |
| CDMACELL Bands | BC0, BC2, BC3, BC7, BC9, BC10, BC12, BC18, BC19 | BC1, BC4, BC6, BC8, BC13, BC14, BC15, BC16, BC20, BC21 | | |
| Return Loss (dB) | ~-12.6 | ~-13.8 | ~-13.9 | ~-8.6 |
| VSWR | ~1.7:1 | ~1.7:1 | ~1.6:1 | ~2.3:1 |
| Efficiency (%) | ~59.7 | ~53.9 | ~57.2 | ~36.9 |
| Peak Gain (dBi) | ~4.6 | ~5.1 | ~5.4 | ~4.8 |
| Average Gain (dB) | ~-2.3 | ~-2.7 | ~-2.4 | ~-4.3 |
| Impedance (Ohm) | 50 | | | |
| Polarisation | Linear | | | |
| Radiation Pattern | Omni-Directional | | | |
| Max. Input Power (W) | 25 | | | |
| Connector Type | SMA-Male Standard (Other Connectors Available) | | | |
| Cable Length | 300 cm Standard (Any Cable Length Available) | | | |
| Cable Type | LL195 Standard (Other Cables Available) | | | |

Antenna Measurement Conditions:

Mounted on Metal Plate of 30 x 30 cm
 100 cm of Cable LL195
 Measured in Certified CTIA 3D Anechoic Chamber

Cable 3

| Parameters | 2.4/5.0/6.0 GHz ISM Antenna | | |
|-----------------------------|---|-----------|-----------|
| Standards | WiFi, BT, ZigBee, ISM, Sigfox, LoRa | | |
| Band (MHz) | 2.4GHz | 5.0 GHz | 6.0GHz |
| Frequency (MHz) | 2410-2490 | 4920-5925 | 5925-7125 |
| Return Loss (dB) | ~-12.8 | ~-12.8 | ~-12.3 |
| VSWR | ~1.6:1 | ~1.7:1 | ~1.8:1 |
| Efficiency (%) | ~59.0 | ~44.8 | ~41.7 |
| Peak Gain (dBi) | ~4.5 | ~5.9 | ~5.7 |
| Average Gain (dB) | ~-2.3 | ~-3.5 | ~-3.8 |
| Impedance (Ohm) | 50 | | |
| Polarisation | Linear | | |
| Radiation Pattern | Omni-Directional | | |
| Max. Input Power (W) | 25 | | |
| Connector Type | SMA-Male-RP Standard (Other Connectors Available) | | |
| Cable Length | 300 cm Standard (Any Cable Length Available) | | |
| Cable Type | LL195 Standard (Other Cables Available) | | |

Cable 4

| Parameters | 2.4/5.0/6.0 GHz ISM Antenna | | |
|-----------------------------|---|-----------|-----------|
| Standards | WiFi, BT, ZigBee, ISM, Sigfox, LoRa | | |
| Band (MHz) | 2.4 GHz | 5.0 GHz | 6.0 GHz |
| Frequency (MHz) | 2410-2490 | 4920-5925 | 5925-7125 |
| Return Loss (dB) | ~-13.0 | ~-11.3 | ~-11.8 |
| VSWR | ~1.6:1 | ~1.9:1 | ~1.8:1 |
| Efficiency (%) | ~60.5 | ~42.9 | ~41.8 |
| Peak Gain (dBi) | ~5.1 | ~6.4 | ~6.6 |
| Average Gain (dB) | ~-2.2 | ~-3.7 | ~-3.8 |
| Impedance (Ohm) | 50 | | |
| Polarisation | Linear | | |
| Radiation Pattern | Omni-Directional | | |
| Max. Input Power (W) | 25 | | |
| Connector Type | SMA-Male-RP Standard (Other Connectors Available) | | |
| Cable Length | 300 cm Standard (Any Cable Length Available) | | |
| Cable Type | LL195 Standard (Other Cables Available) | | |

Antenna Measurement Conditions:

Mounted on Metal Plate of 30 x 30 cm
 100 cm of Cable LL195
 Measured in Certified CTIA 3D Anechoic Chamber

Cable 5

| Parameters | GPS/GLONASS Antenna | |
|---------------------------------|--|-----------|
| | GPS/QZSS/Galileo | GLONASS |
| Standards | | |
| Band (MHz) | 1575 | 1602 |
| Frequency(MHz) | 1575.42 | 1598-1610 |
| Patch Size (mm) | 25 x 25 x 4 | |
| Return Loss (dB) | <=-15.0 dB | |
| VSWR | <=1.4:1 dB | |
| Impedance | 50 | |
| Radiation Pattern | Hemispherical | |
| Polarization | RHCP | |
| Saw Filter | Pre-filter | |
| Active Gain (dB) | 28 @ 2.7 V | |
| Noise Figure (dB) | 1.5 Typ | |
| Voltage (V) | 1.5 – 3.6 | |
| Current Consumption (mA) | 9 Typ | |
| Power Consumption (mW) | 24.3 Typ | |
| ESD Protection (kV) | 2kV | |
| Connector Type | SMA-Male Standard (Other Connectors Available) | |
| Cable Length | 300 cm Standard (Any Cable Length Available) | |
| Cable Type | LL100 Standard (Other Cables Available) | |

2. Mechanical and environmental specifications

| Specifications | 2J6C86MGFa |
|----------------------------------|-------------------|
| Mounting Type | Magnetic Mount |
| Dimensions (mm) | 193 × 76.5 × 56.1 |
| Radome Type | ASA |
| Radome color | Black, White |
| Operating Temperature (C) | -40 to +85 |
| Storage Temperature (C) | -40 to +85 |
| Substance Compliance | RoHS |
| Certificates | IP67, IP69 |

3. Antenna parameters

Cable 1: 5G NR

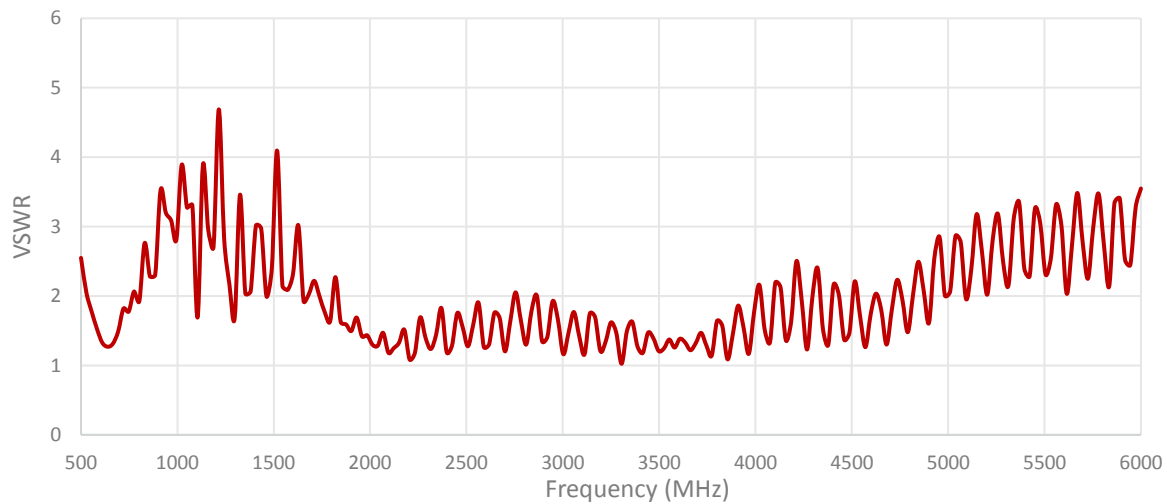
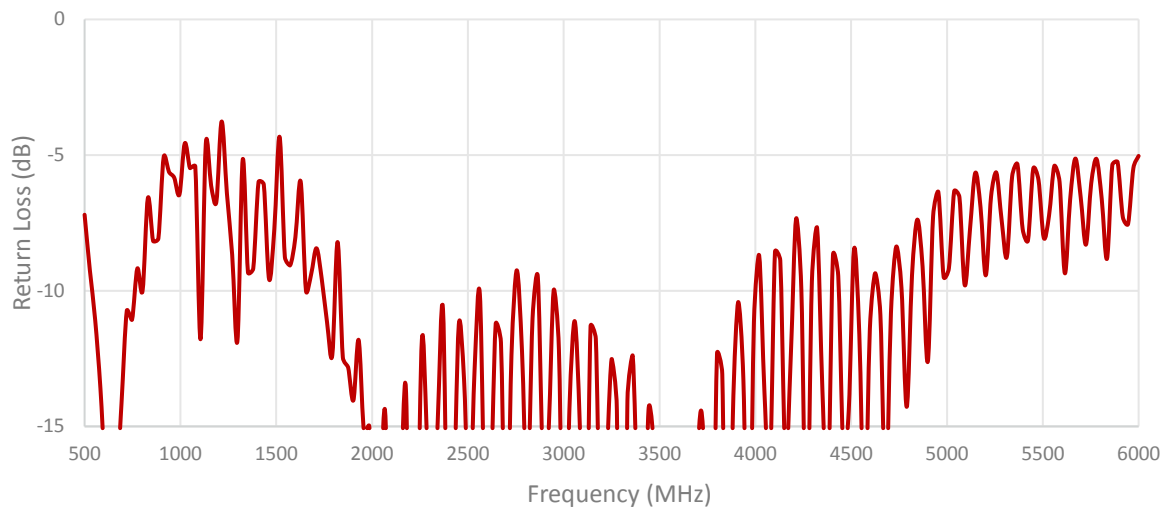

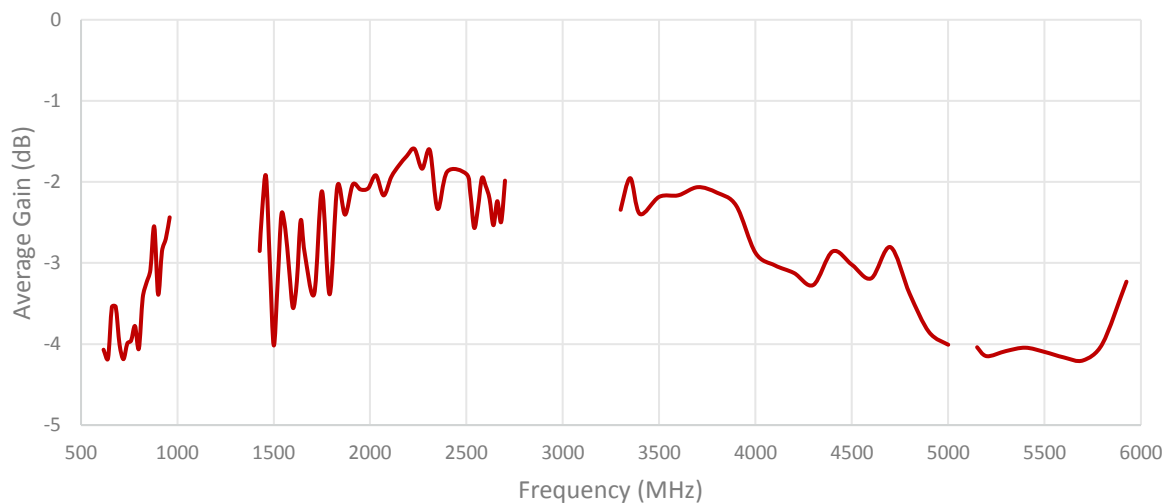
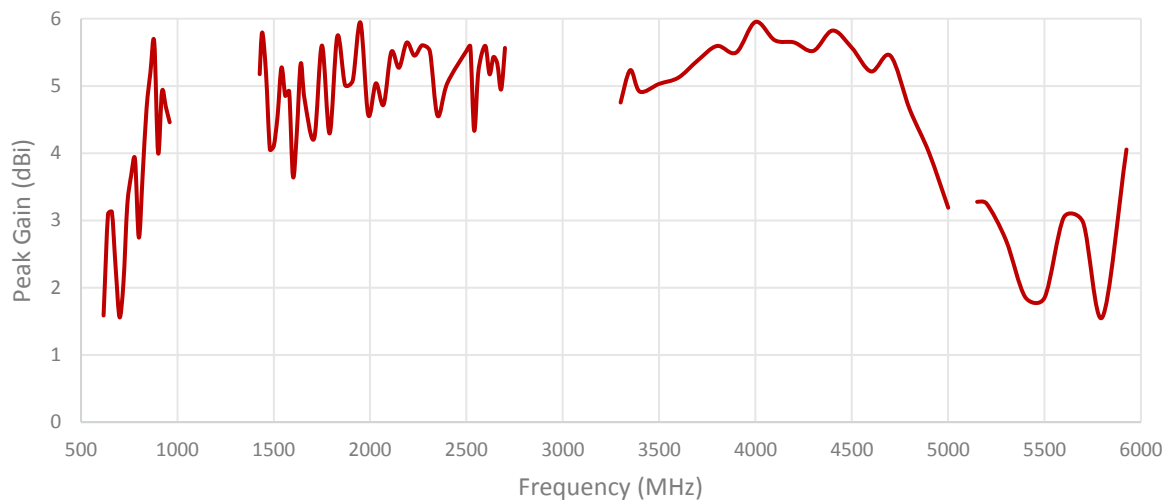
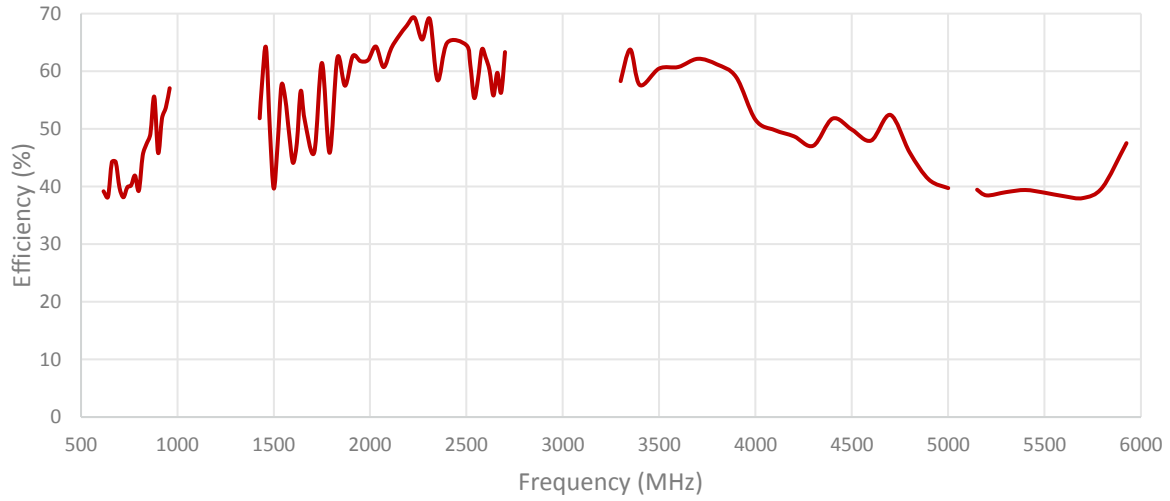

Cable 2: 5GNR

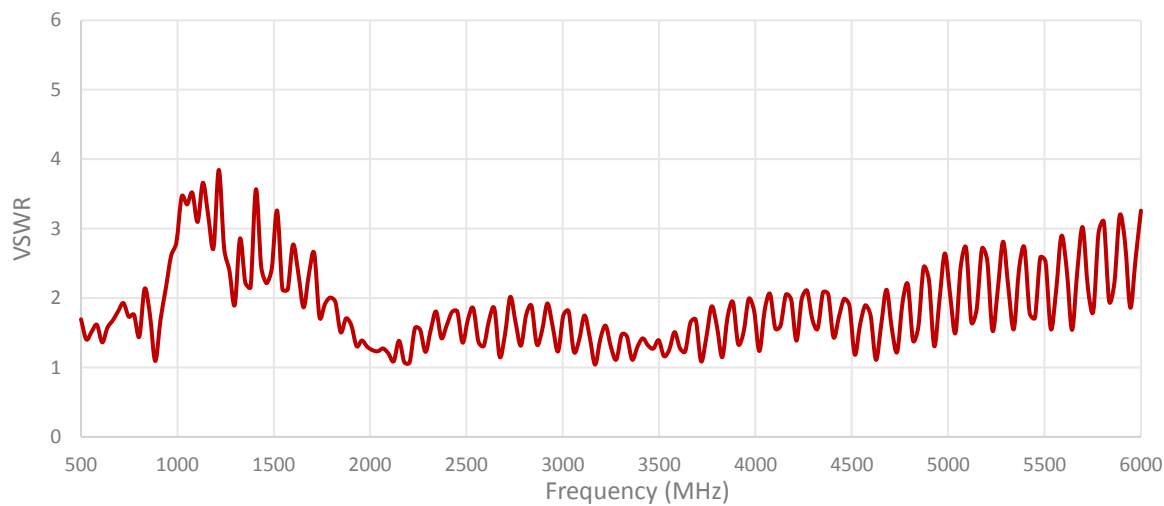
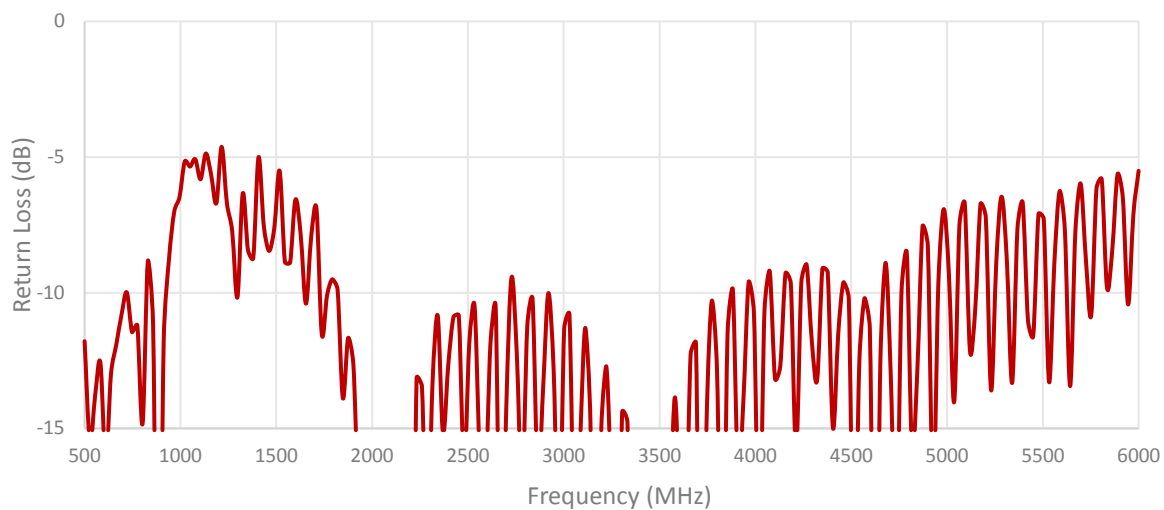

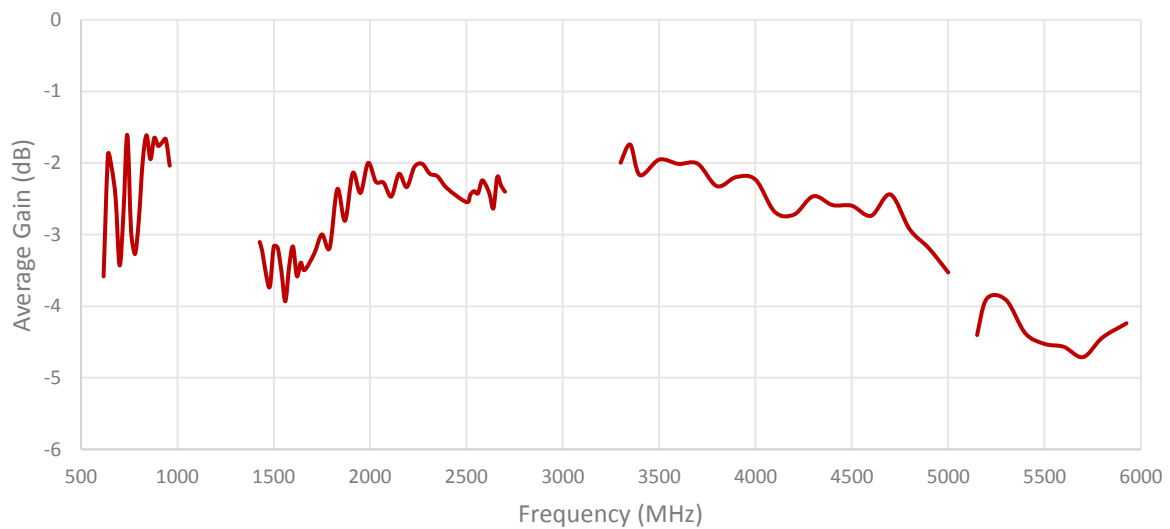
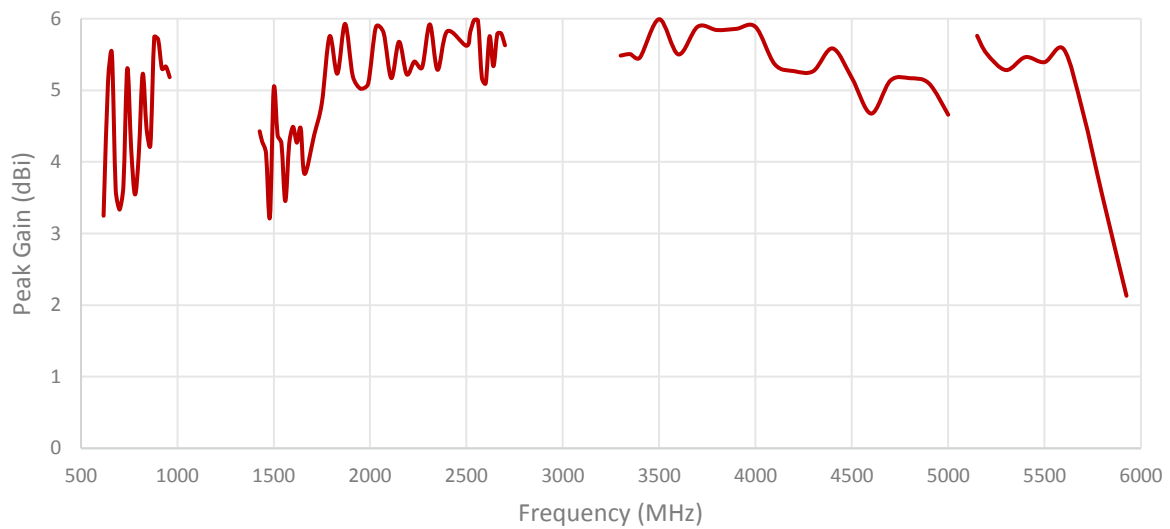
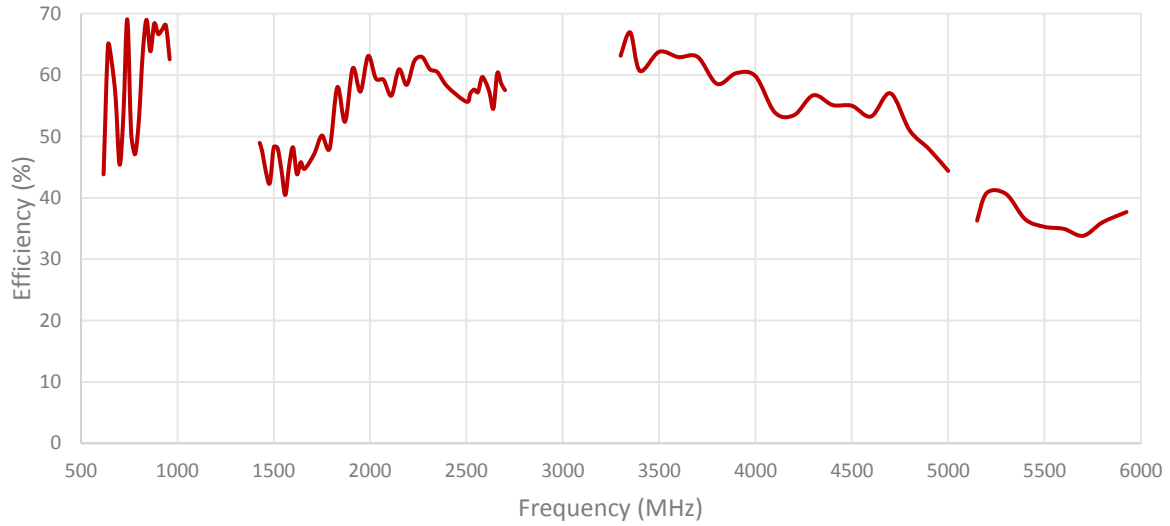

ISOLATION FOR CABLES 1 AND 2

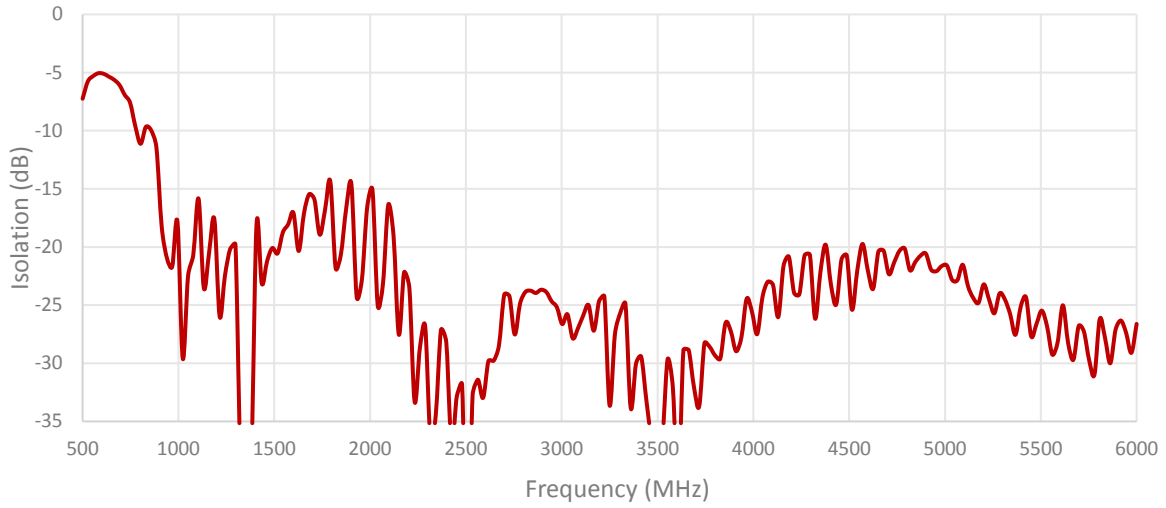

ENVELOPE CORRELATION COEFFICIENT FOR CABLES 1 AND 2

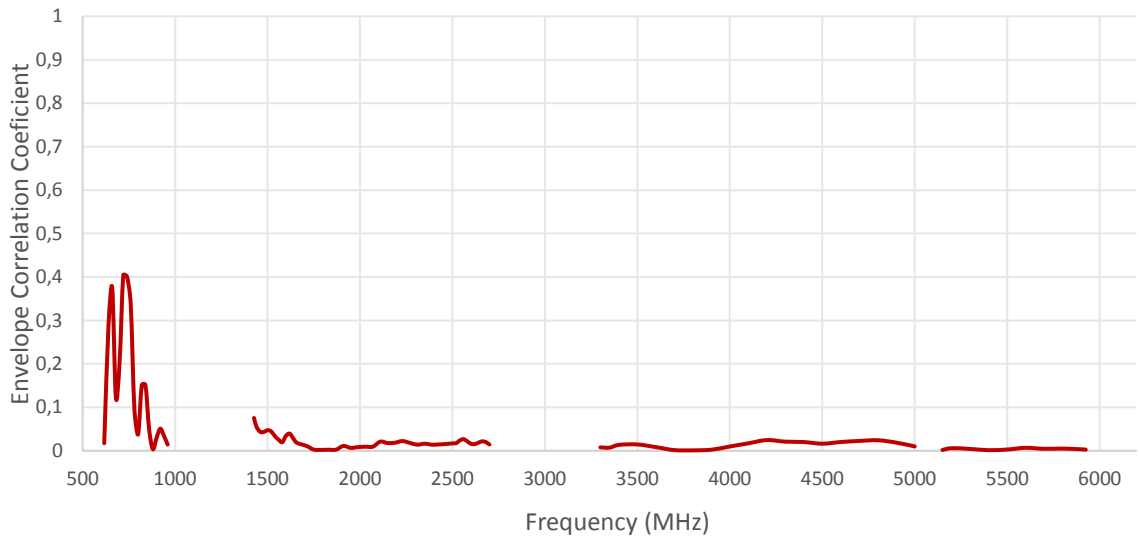

Cable 3: 2.4/5.0/6.0 GHz ISM

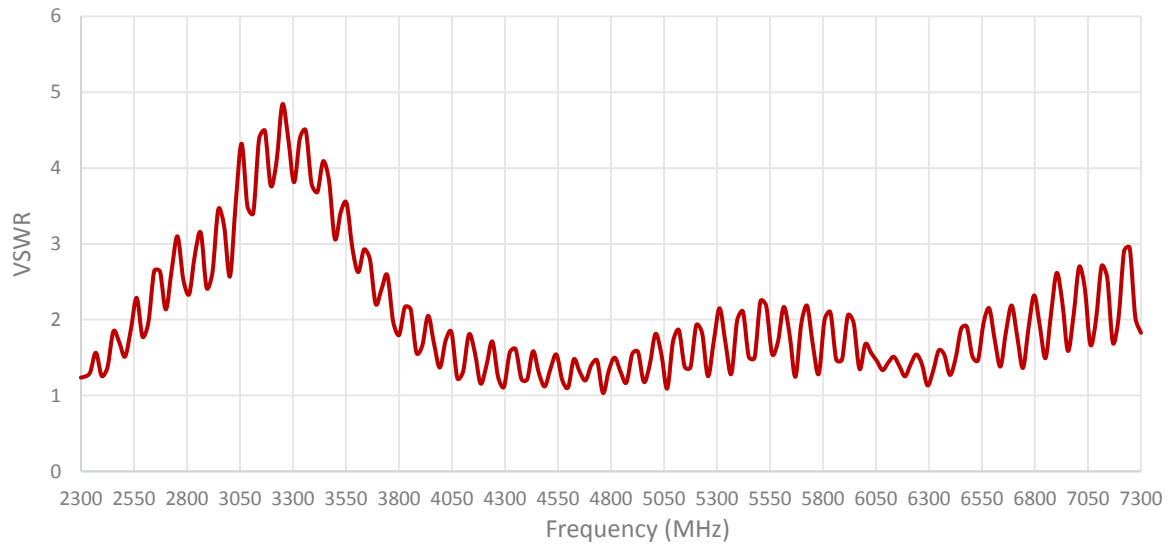
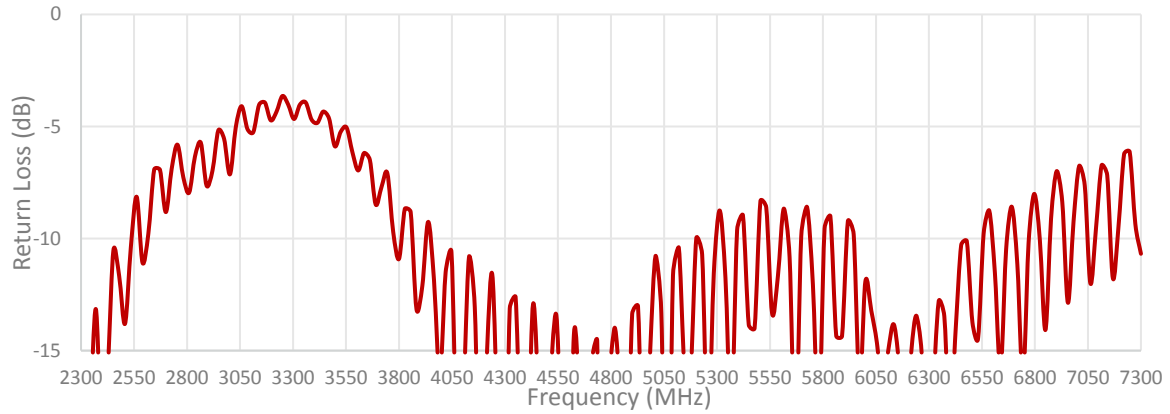

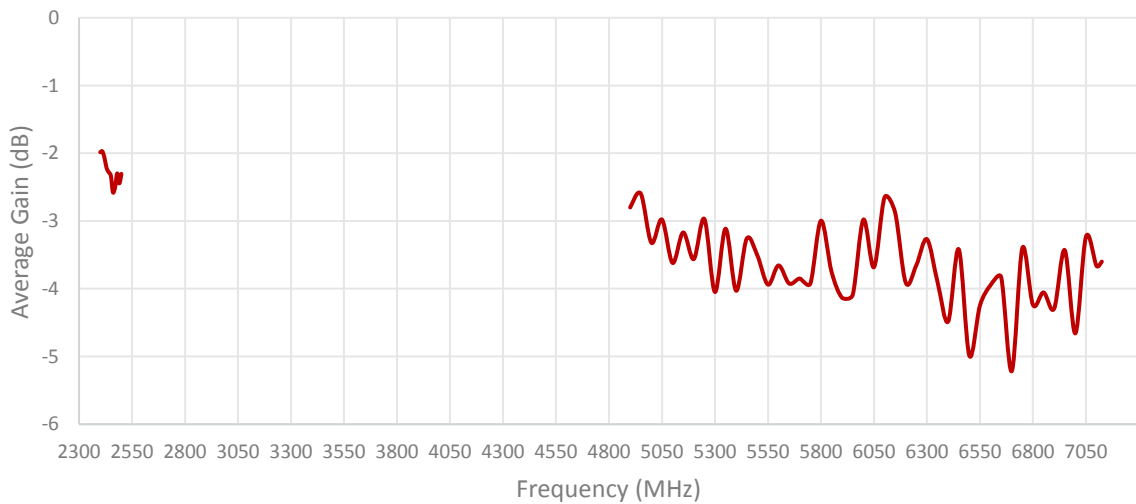
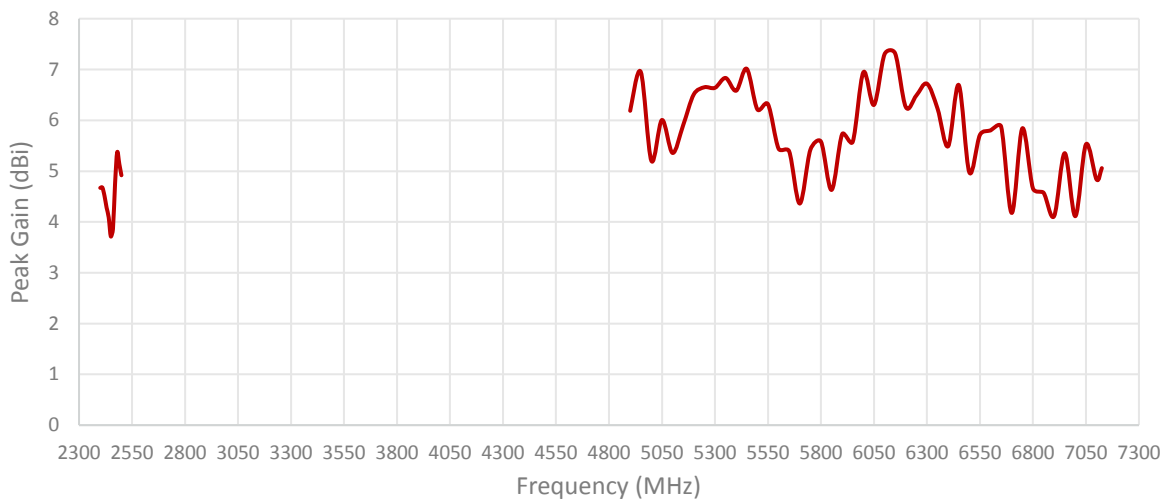
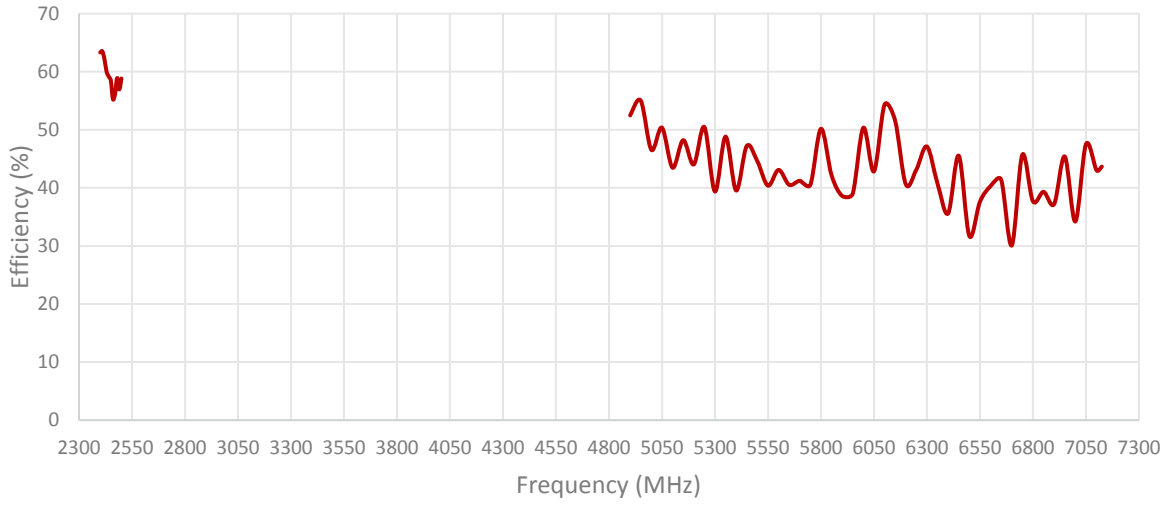
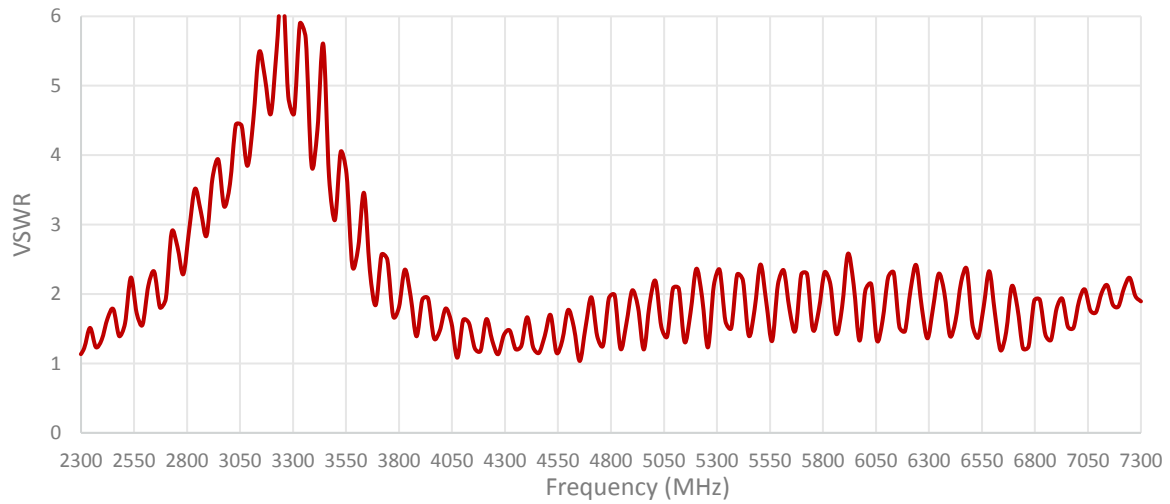
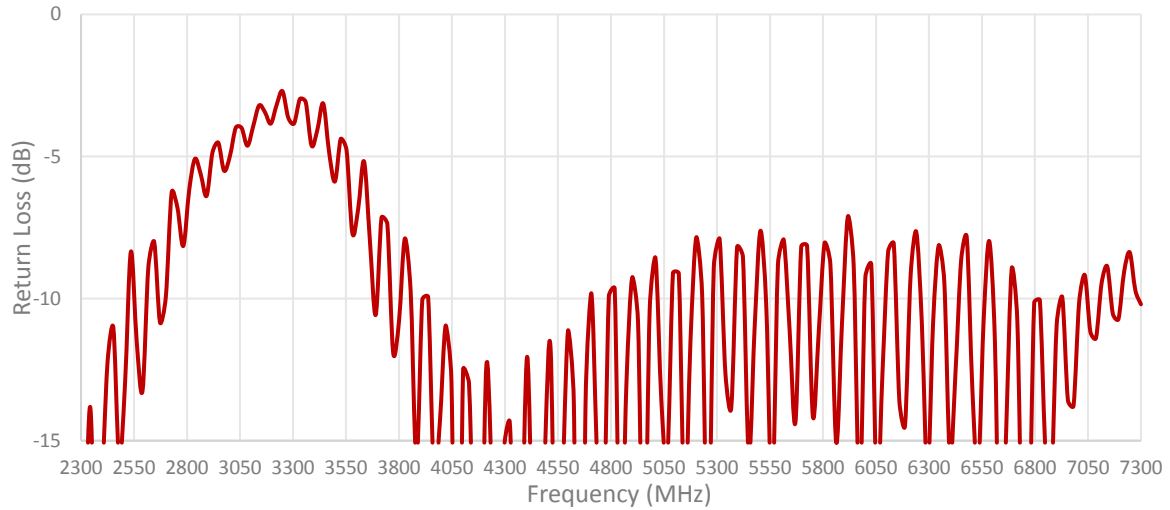
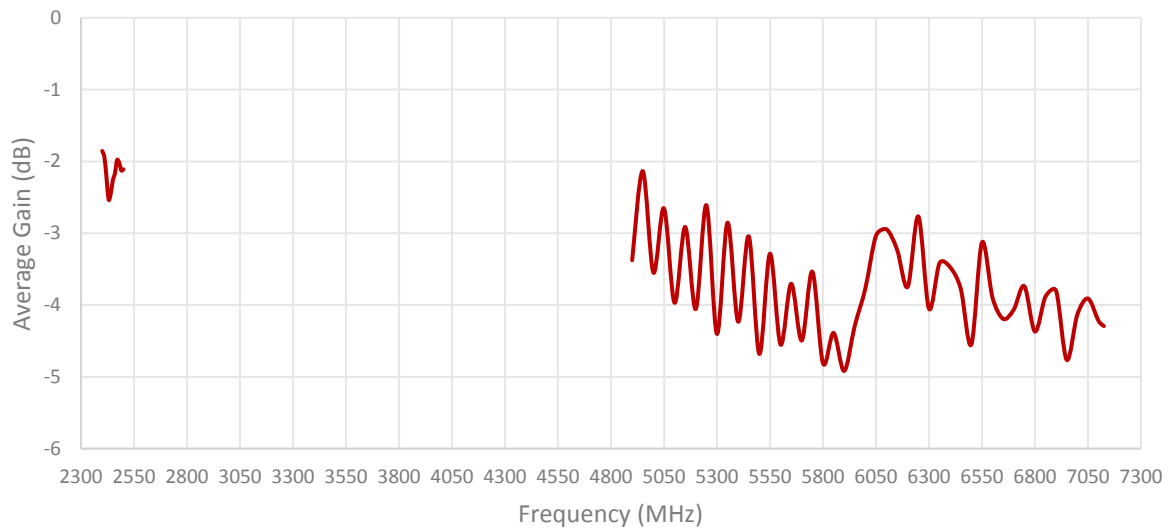
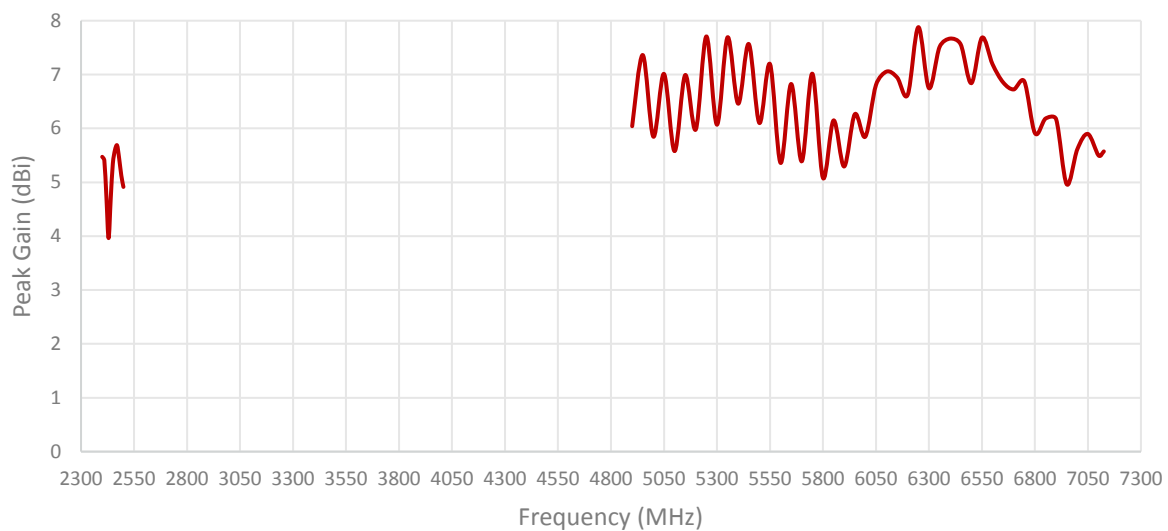
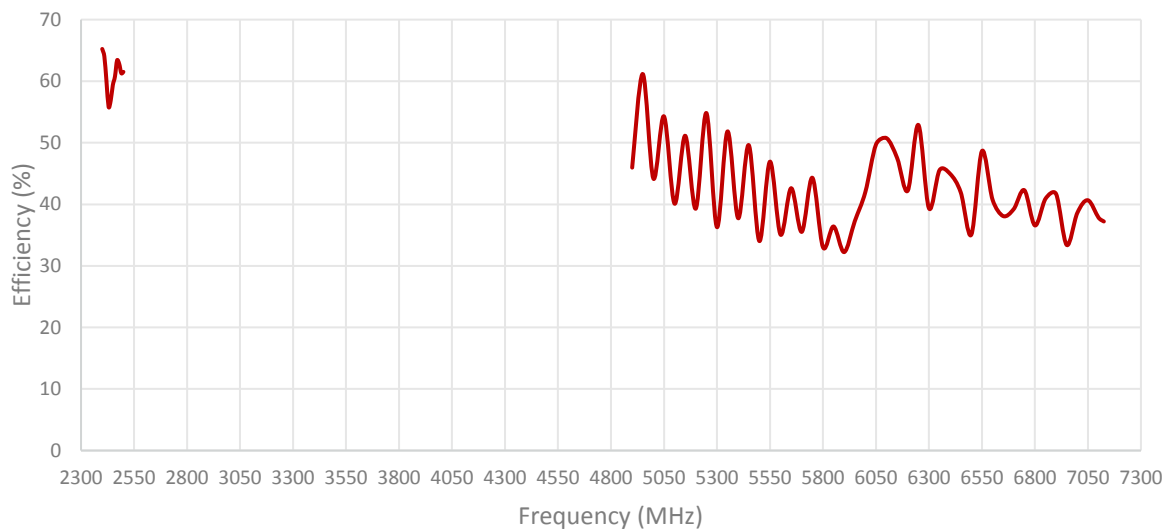
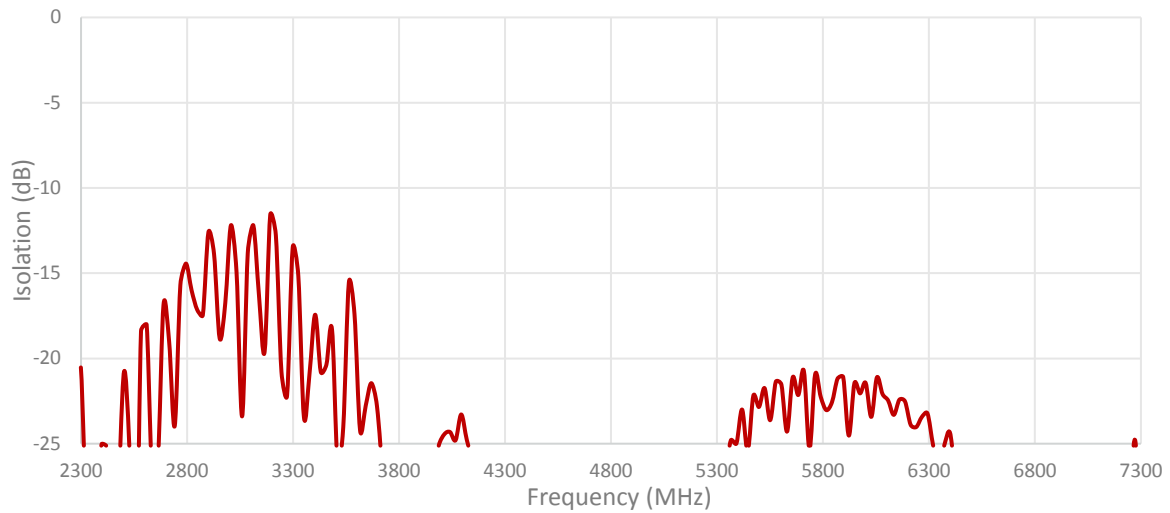

Table 4: 2.4/5.0/6.0 GHz ISM





ISOLATION FOR CABLES 3 AND 4



ENVELOPE CORRELATION COEFFICIENT FOR CABLES 3 AND 4

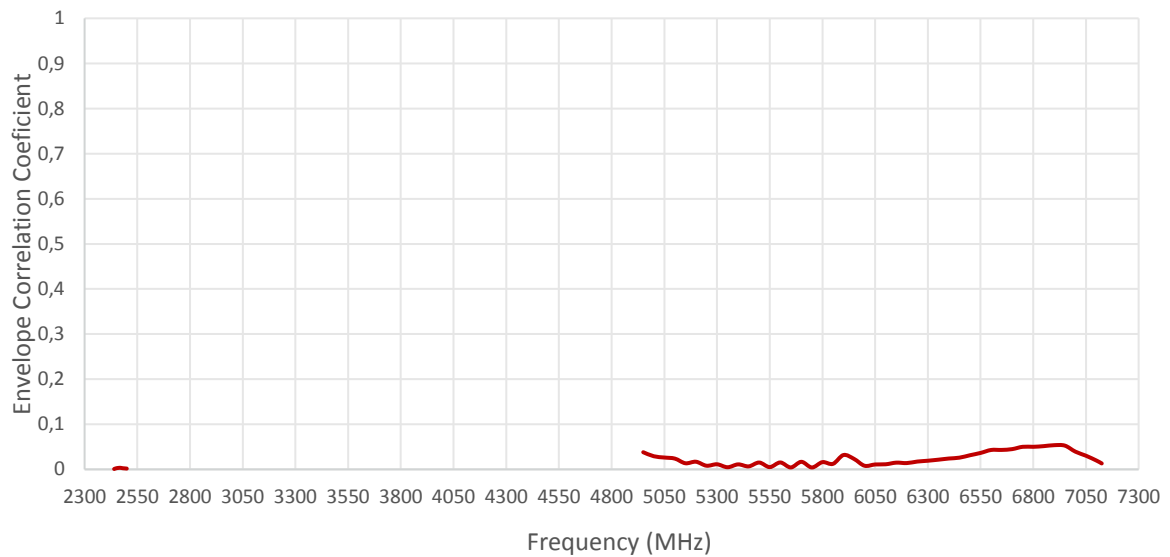

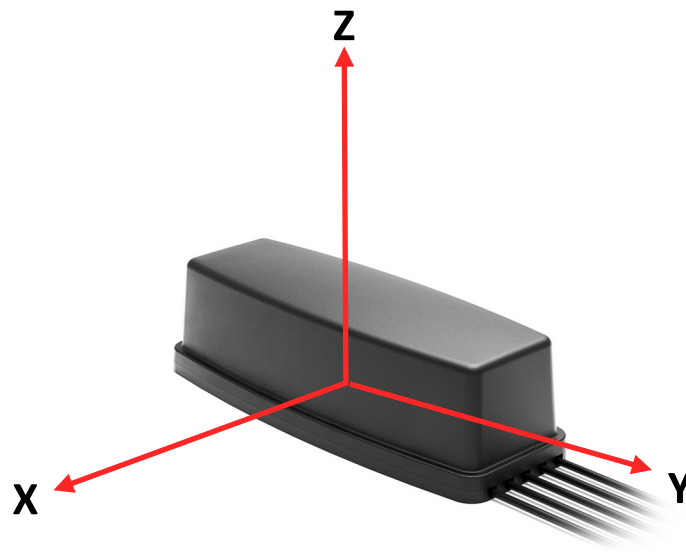

Radiation pattern reference

Cable 1: 5GNR

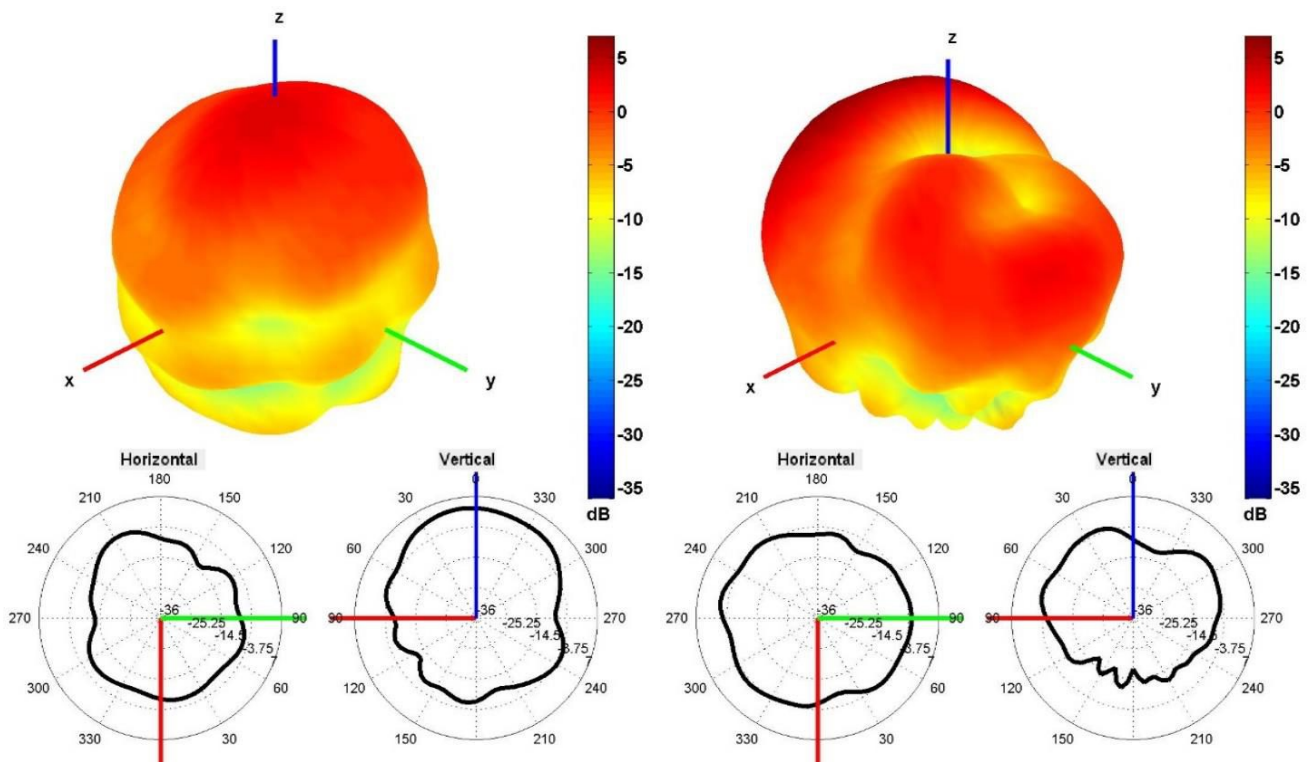

740 and 2500 MHz Radiation pattern

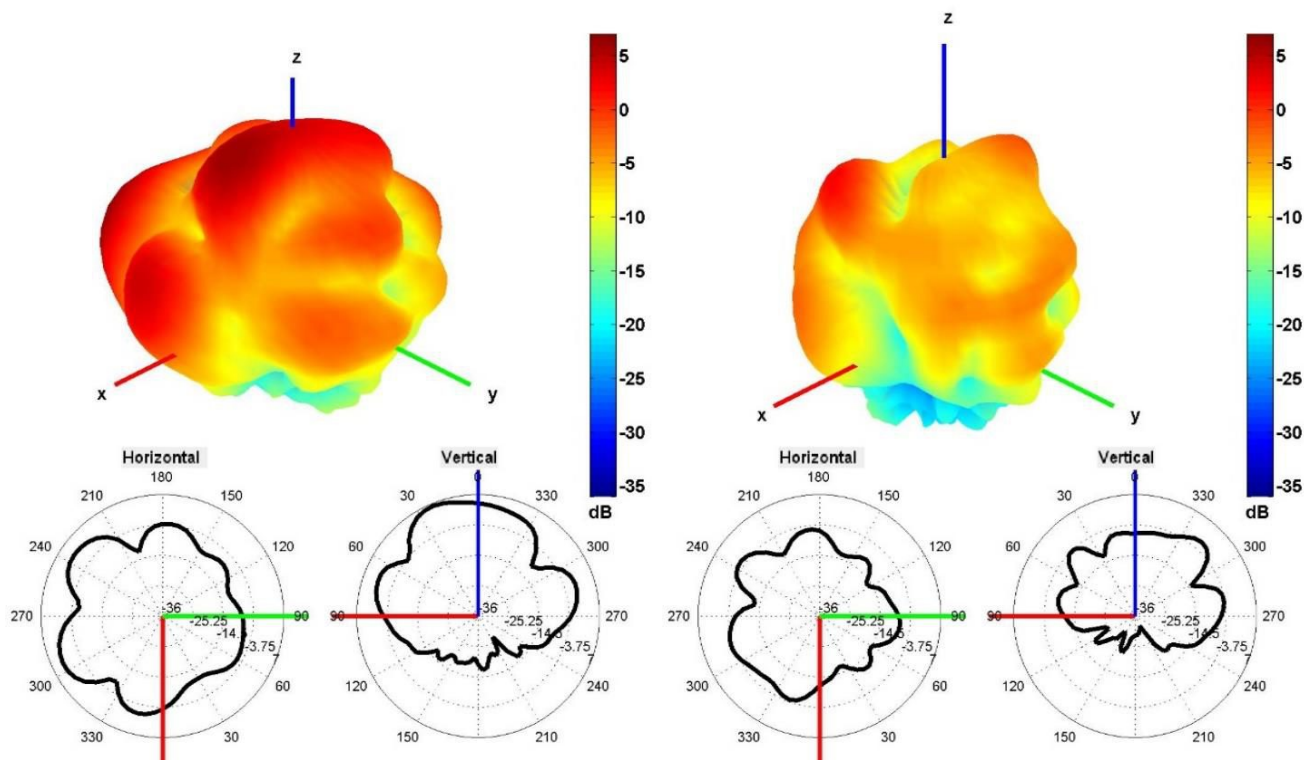

4500 and 5500 MHz Radiation pattern

Cable 2: 5GNR

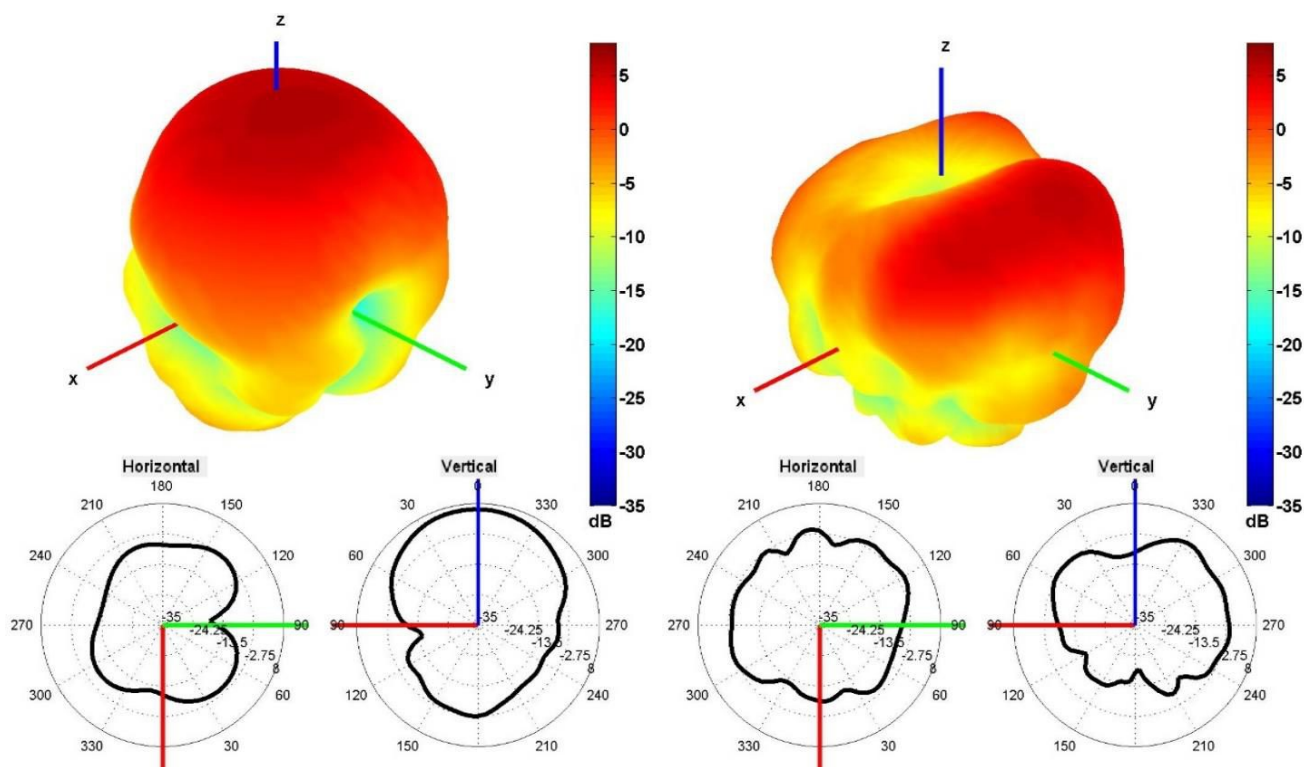

740 and 2500 MHz Radiation pattern

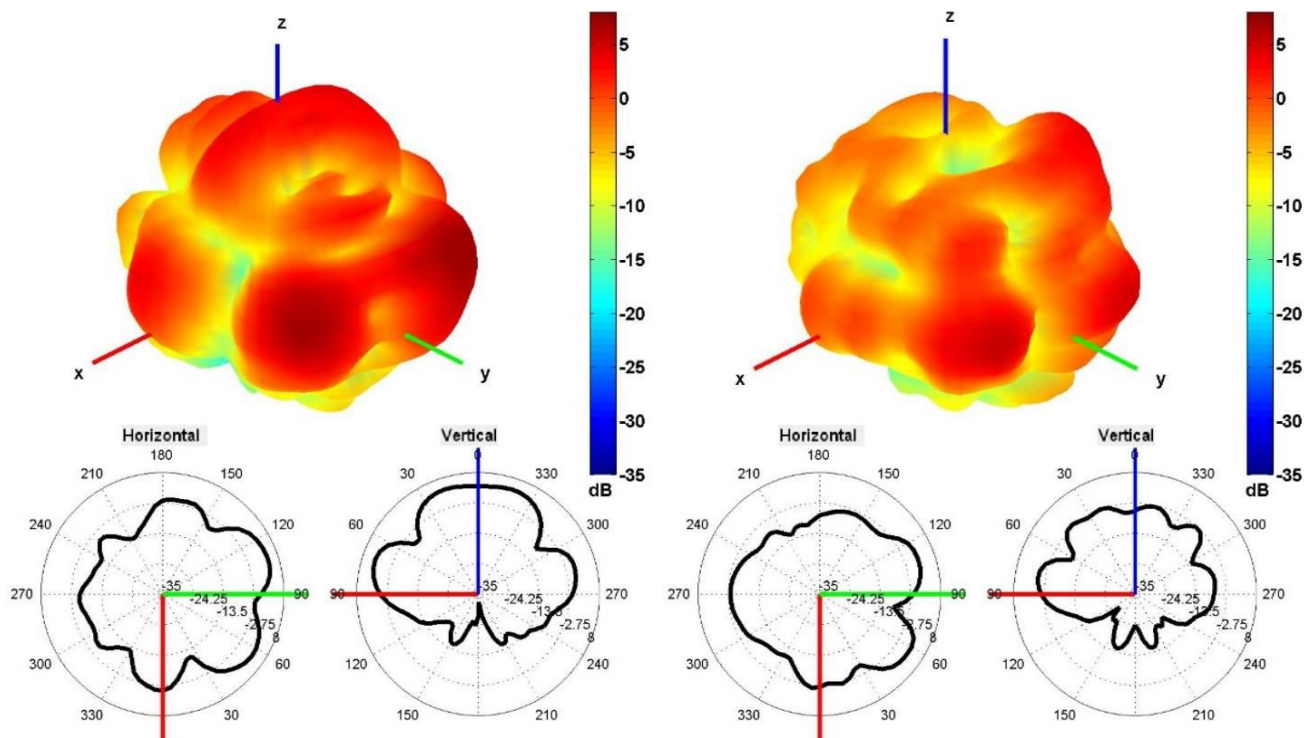

4500 and 5500 MHz Radiation pattern

Cable 3: 2.4/5.0/6.0 GHz ISM

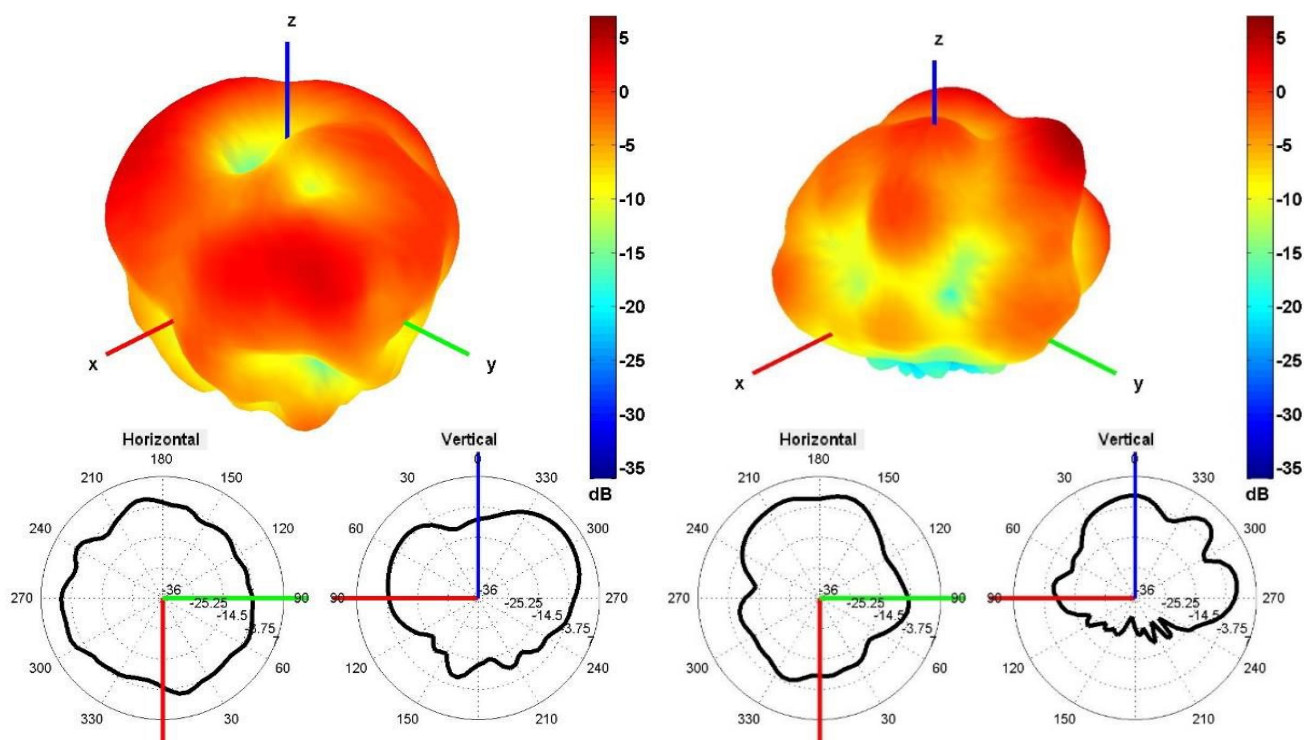

2450 and 5500 MHz Radiation pattern

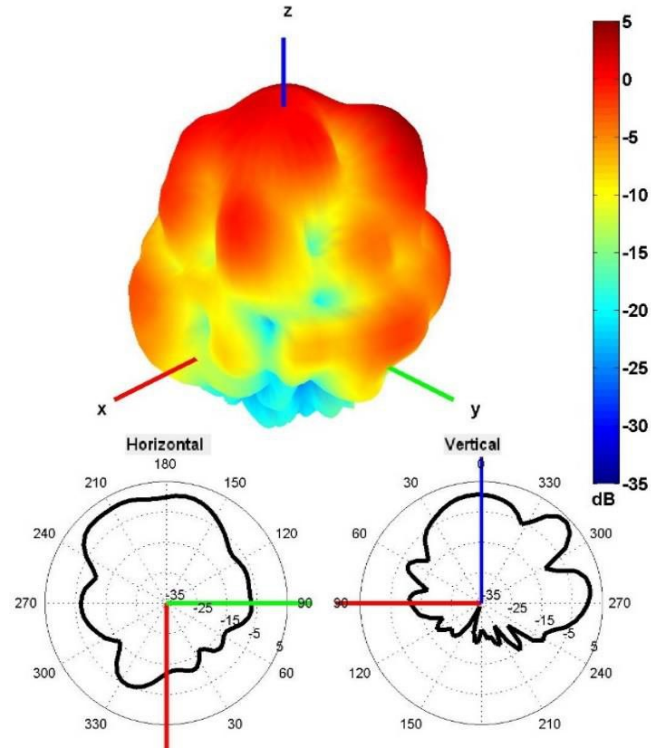

6500 MHz Radiation pattern

Table 4: 2.4/5.0/6.0 GHz ISM

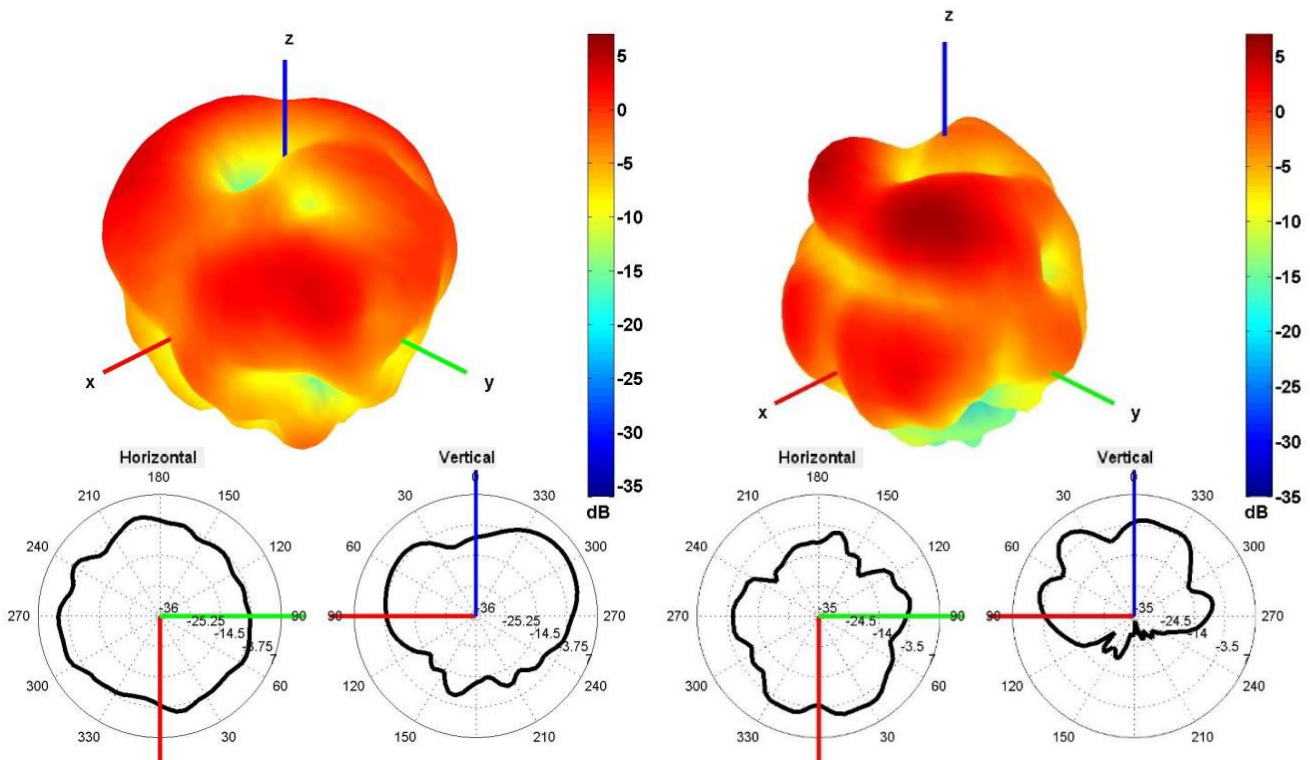

2450 and 5500 MHz Radiation pattern

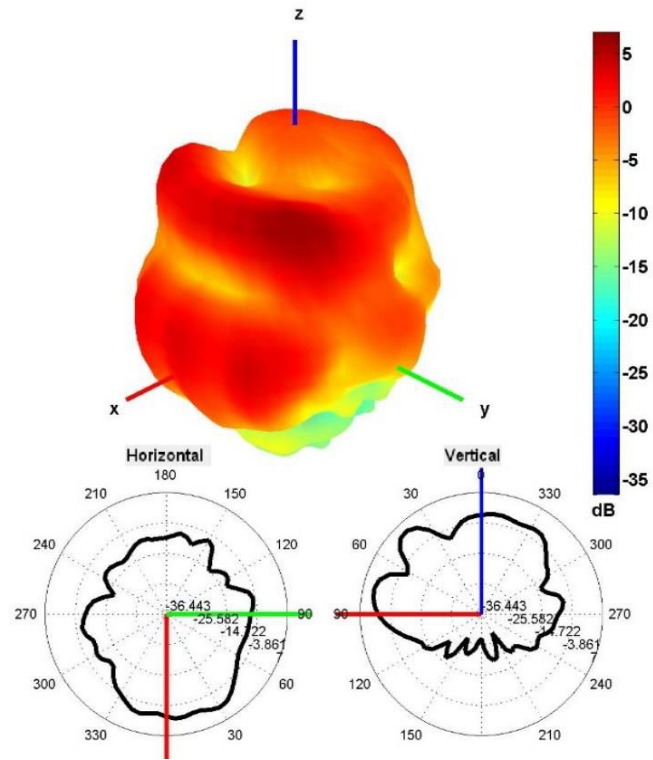

6500 MHz Radiation pattern

4. Antenna drawings

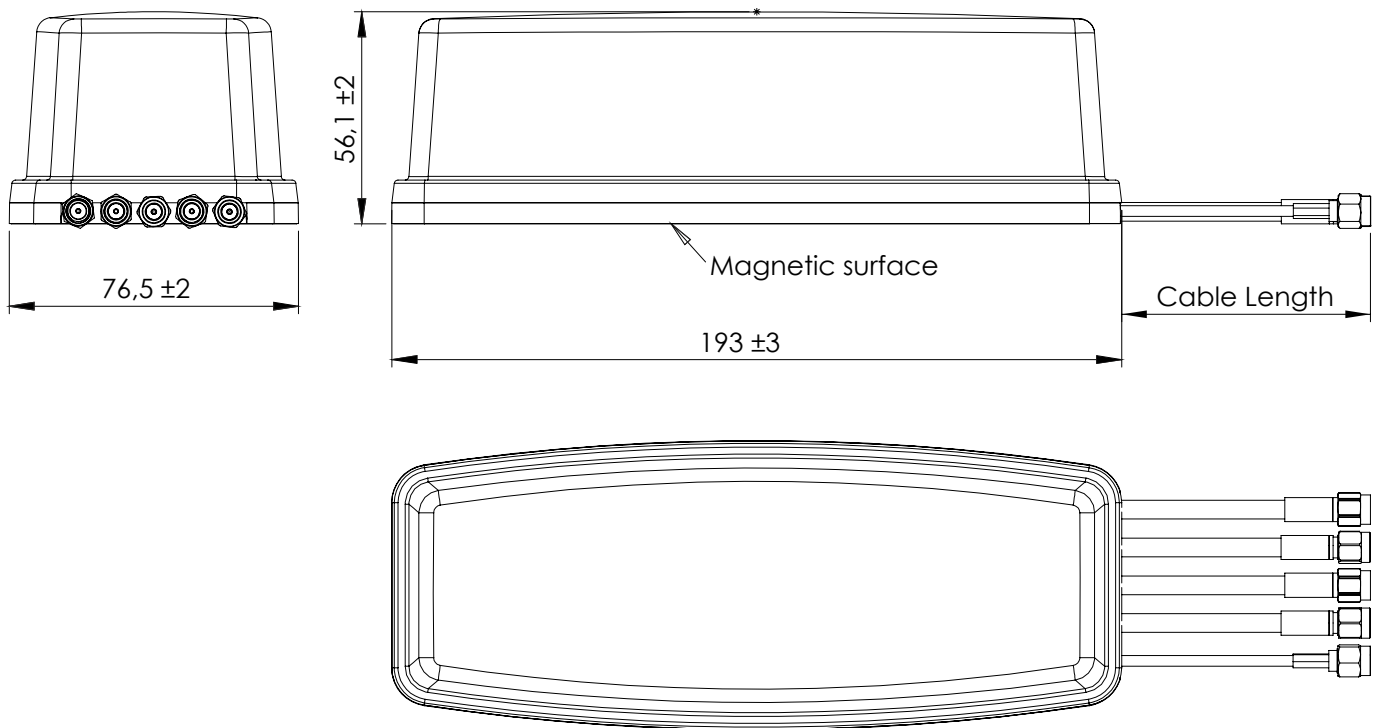

Note: Dimensions are in millimeters
***Dimensions are after mounting**

5. Antenna Images

