

## 2J6984MPGFa

5GNR MIMO and GNSS Magnetic/Adhesive Mount

### Key Features

#### Cable 1 - 2 : 5GNR

- 617-960 MHz
- 1427-2690 MHz
- 3300-5000 MHz
- 5150-5925 Mhz

#### Cable 3: GPS/GLONASS/QZSS/Galileo

- 1575-1606 MHz

Magnetic/Adhesive Mount

Low Profile

High Gain

Ground Plane Independent

Customizable Cable and Connector

Dimensions 89 × 76 × 27/30 mm

Certificates: IP67, IP69



## 1. Antenna and electrical specifications

Cable 1

Parameters	5G NR Antenna			
Technologies	5G, 4G, 3G and 2G			
Standards	5G NR/4GLTE/FirstNet/CBRS/LPWA/CAT-X/CAT-Mx/CAT-NBx/NB-IoT/3G/2G			
Frequency (MHz)	617-960	1427-2690	3300-5000	5150-5925
Band (MHz)	600, 700, 850, 900	1500, 1600, 1700, 1800, 1900, 2000, 2100, 2300, 2500, 2600	3300, 3500, 3600, 3700, 4500	5200, 5500, 5800
5G NR Bands	n5, n8, 12, n20, n28, n71, n81, n82, n83,	n1, n2, n3, n7, n25, n34, n38, n39, n40, n41, n50, n51, n66, n70, n74, n75, n76, n80, n84, n86	n77, n78, n79	
4GLTE Bands	B5, B6, B8, B12, B13, B14, B17, B18, B19, B20, B26, B27, B28, B29, B44, B67, B68, B71, B85	B1, B2, B3, B4, B7, B9, B10, B11, B21, B23, B24, B25, B30, B32, B33, B34, B35, B36, B37, B38, B39, B40, B41, B45, B50, B51, B65, B66, B69, B70, B74, B75, B76	B22, B42, B43, B48, B49, B52	B46, B47, B252, B255
3GCELL Bands	B5, B6, B8, B12, B13, B14, B19, B20, B26	B1, B2, B3, B4, B7, B9, B10, B11, B21, B25, B32, B33, B34, B35, B36, B37, B38, B39, B40	B22	
2GCELL Bands	710, 750, 810T, 850, 900P, 900E, 900R	1800DCS, 1900PCS		
CDMA CELL Bands	BC0, BC2, BC3, BC7, BC9, BC10, BC12, BC18, BC19	BC1, BC4, BC6, BC8, BC13, BC14, BC15, BC16, BC20, BC21		
Return Loss (dB)	~-11.2	~-8.3	~-7.1	~-7.4
VSWR	~2.0:1	~2.6:1	~3.2:1	~2.6:1
Efficiency (%)	~46.2	~50.5	~32.5	~30.5
Peak Gain (dBi)	~2.1	~5.4	~3.8	~3.9
Average Gain (dB)	~-3.5	~-3.1	~-5.1	~-5.2
Impedance (Ohm)	50			
Polarisation	Linear			
Radiation Pattern	Omni-Directional			
Max. Input Power (W)	25			
Connector Type	SMA-Male Standard (Other Connectors Available)			
Cable Length	300 cm Standard (Any Cable Length Available)			
Cable Type	D302 Standard (Other Cables Available)			

**Cable 2**

Parameters	5GNR Antenna			
Technologies	5G, 4G, 3G and 2G			
Standards	5GNR/4GLTE/FirstNet/CBRS/LPWA/CAT-X/CAT-Mx/CAT-NBx/NB-IoT/3G/2G			
Frequency (MHz)	617-960	1427-2690	3300-5000	5150-5925
Band (MHz)	600, 700, 850, 900	1500, 1600, 1700, 1800, 1900, 2000, 2100, 2300, 2500, 2600	3300, 3500, 3600, 3700, 4500	5200, 5500, 5800
5GNR Bands	n5, n8 ,12, n20, n28, n71, n81, n82, n83,	n1, n2, n3, n7, n25, n34, n38, n39, n40, n41, n50, n51, n66, n70, n74, n75, n76, n80, n84, n86	n77, n78, n79	
4GLTE Bands	B5, B6, B8, B12, B13, B14, B17, B18, B19, B20, B26, B27, B28, B29, B44, B67, B68, B71, B85	B1, B2, B3, B4, B7, B9, B10, B11, B21, B23, B24, B25, B30, B32, B33, B34, B35, B36, B37, B38, B39, B40, B41, B45, B50, B51, B65, B66, B69, B70, B74, B75, B76	B22, B42, B43, B48, B49, B52	B46, B47, B252, B255
3GCELL Bands	B5, B6, B8, B12, B13, B14, B19, B20, B26	B1, B2, B3, B4, B7, B9, B10, B11, B21, B25, B32, B33, B34, B35, B36, B37, B38, B39, B40	B22	
2GCELL Bands	710, 750, 810T, 850, 900P, 900E, 900R	1800DCS, 1900PCS		
CDMACELL Bands	BC0, BC2, BC3, BC7, BC9, BC10, BC12, BC18, BC19	BC1, BC4, BC6, BC8, BC13, BC14, BC15, BC16, BC20, BC21		
Return Loss (dB)	~-9.6	~-8.2	~-6.9	~-7.0
VSWR	~2.2:1	~2.6:1	~3.3:1	~2.8:1
Efficiency (%)	~45.1	~52.0	~40.1	~33.5
Peak Gain (dBi)	~3.2	~5.6	~5.1	~4.7
Average Gain (dB)	~-3.7	~-3.0	~-4.3	~-4.9
Impedance (Ohm)	50			
Polarisation	Linear			
Radiation Pattern	Omni-Directional			
Max. Input Power (W)	25			
Connector Type	SMA-Male Standard (Other Connectors Available)			
Cable Length	300 cm Standard (Any Cable Length Available)			
Cable Type	D302 Standard (Other Cables Available)			

**Antenna Measurement Conditions:**

Mounted on 30 x 30 Metal Plate

100 cm of Cable D302

Measured in Certified CTIA 3D Anechoic Chamber

Cable 3

Parameters	GPS/GLONASS Antenna	
	GPS/QZSS/Galileo	GLONASS
<b>Standard</b>		
<b>Band (MHz)</b>	1575	1602
<b>Frequency(MHz)</b>	1575.42	1598-1606
<b>Patch Size (mm)</b>	18 × 18 × 4	
<b>Return Loss (dB)</b>	<= -15.0 dB	
<b>VSWR</b>	<= 1.4:1 dB	
<b>Impedance</b>	50	
<b>Radiation Pattern</b>	Hemispherical	
<b>Polarization</b>	RHCP	
<b>Saw Filter</b>	Pre-filter	
<b>Active Gain (dB)</b>	28 @ 2.7 V	
<b>Noise Figure (dB)</b>	1.5 Typ	
<b>Voltage (V)</b>	1.5 – 3.6	
<b>Current (mA)</b>	9 Typ	
<b>Power Consumption (mW)</b>	24.3 Typ	
<b>ESD Protection (kV)</b>	2kV	
<b>Connector Type</b>	SMA-Male Standard (Other Connectors Available)	
<b>Cable Length</b>	300 cm Standard (Any Cable Length Available)	
<b>Cable Type</b>	D100 Standard (Other Cables Available)	

## 2. Mechanical and environmental specifications

Specifications	2J6984MPGFa
<b>Mounting Type</b>	Magnetic/Adhesive Mount
<b>Dimensions (mm)</b>	89 × 76 × 27/30
<b>Radome Type</b>	ASA
<b>Radome Color</b>	Black, White
<b>Operating Temperature (C)</b>	-40 to +85
<b>Storage Temperature (C)</b>	-40 to +85
<b>Substance Compliance</b>	RoHS
<b>Certificates</b>	IP67, IP69,

### 3. Antenna parameters

Cable 1: 5GNR

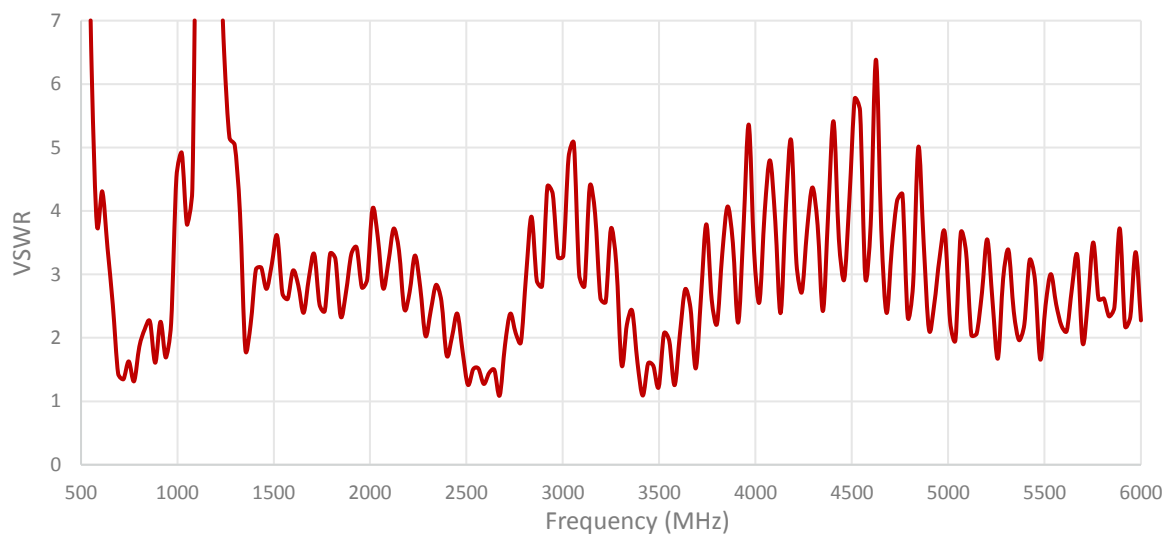
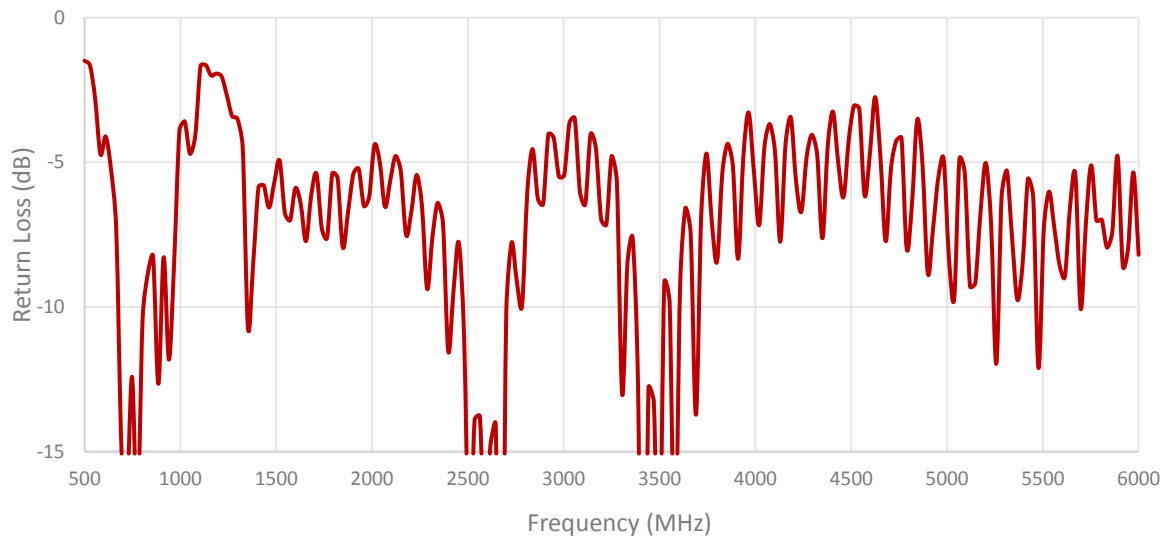

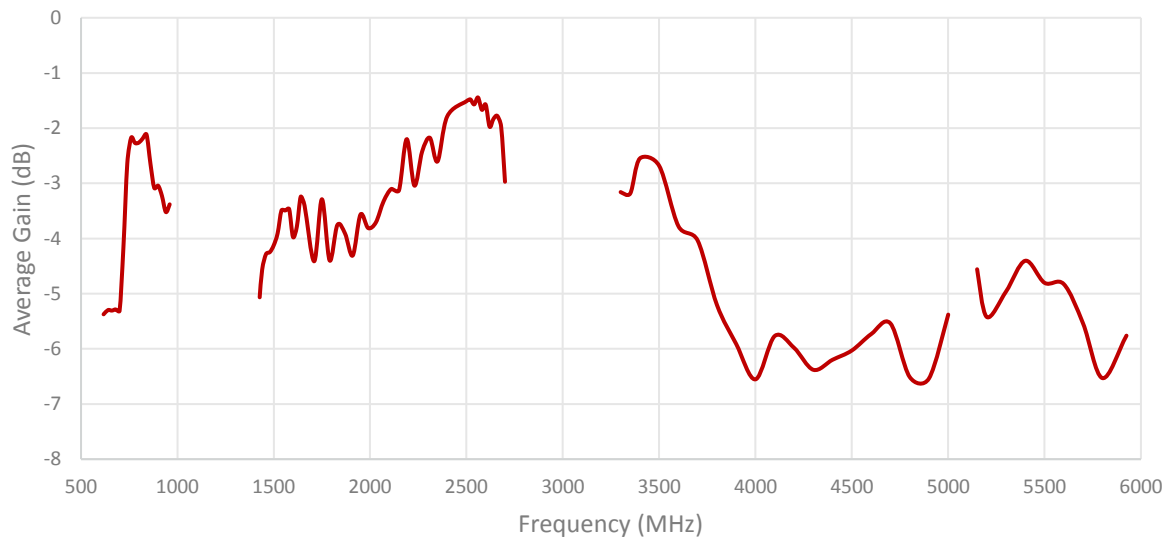
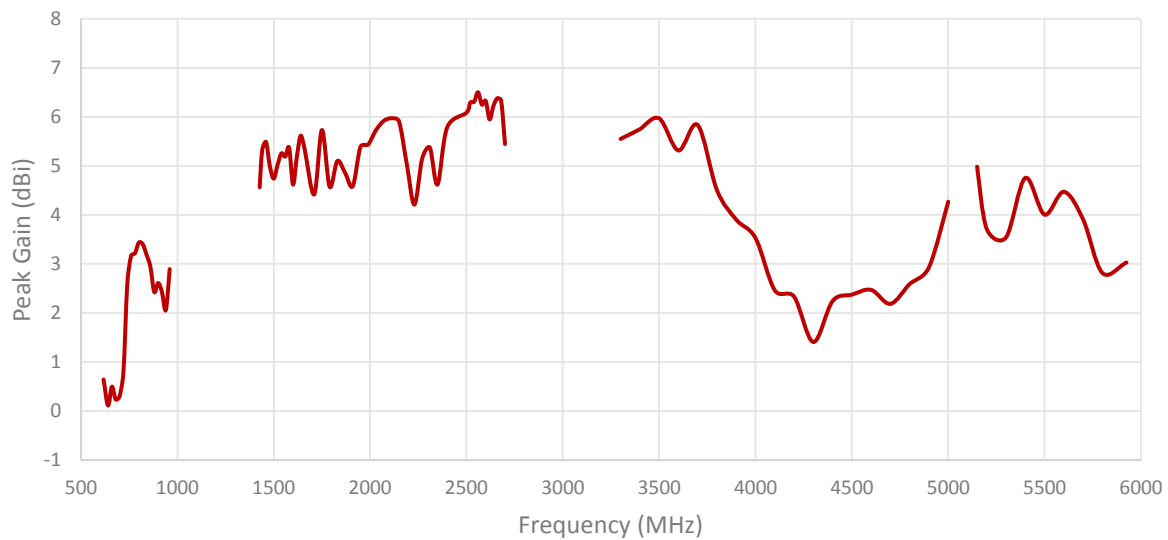
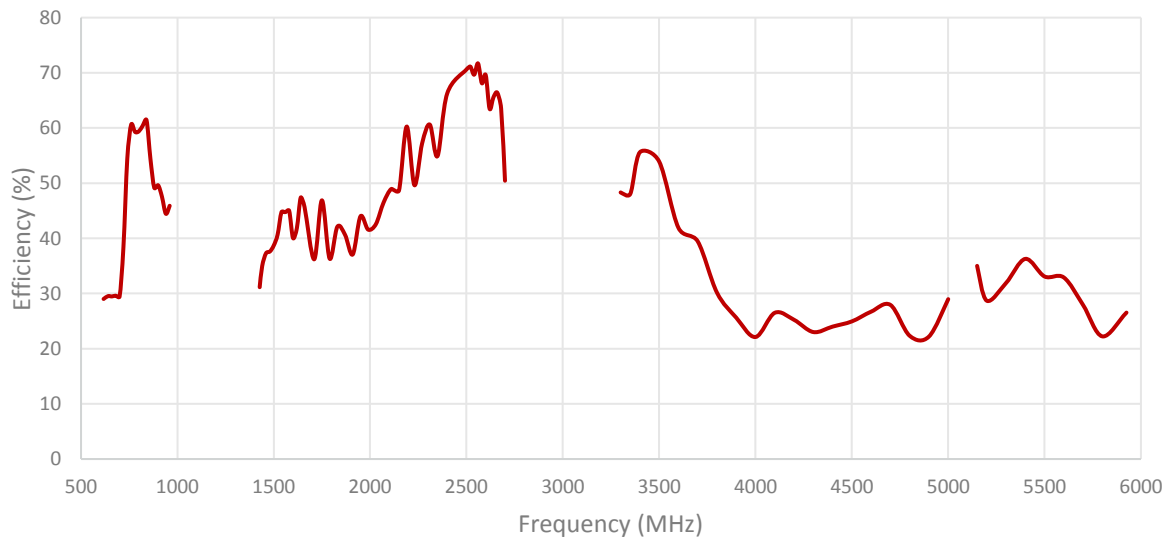

**Cable 2: 5GNR**

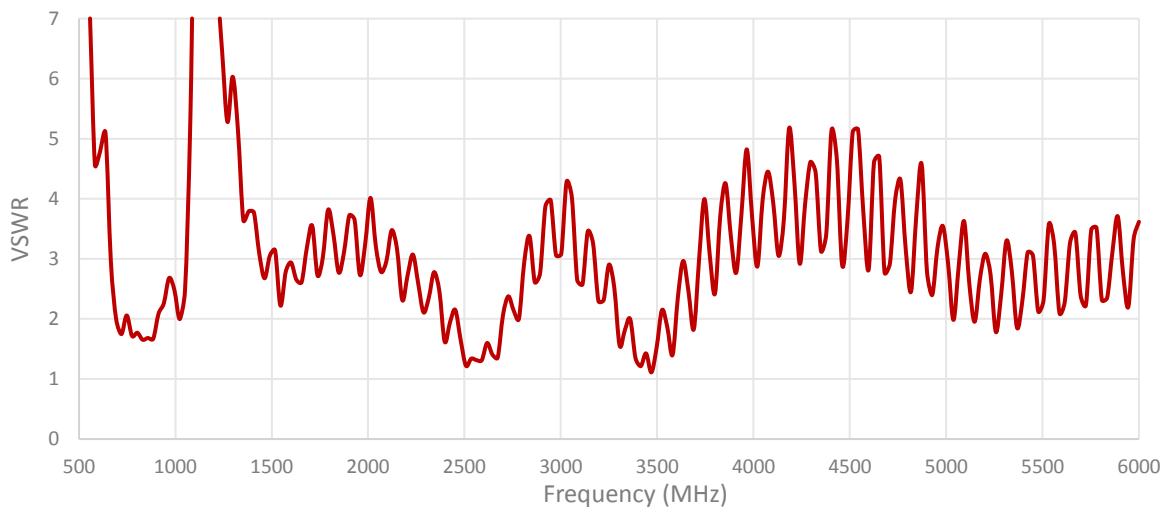
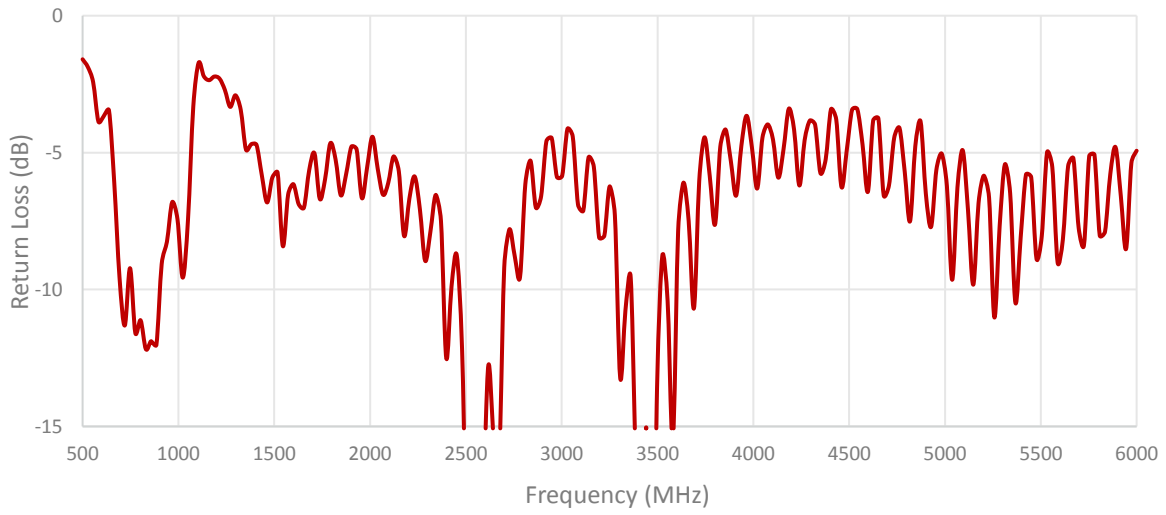

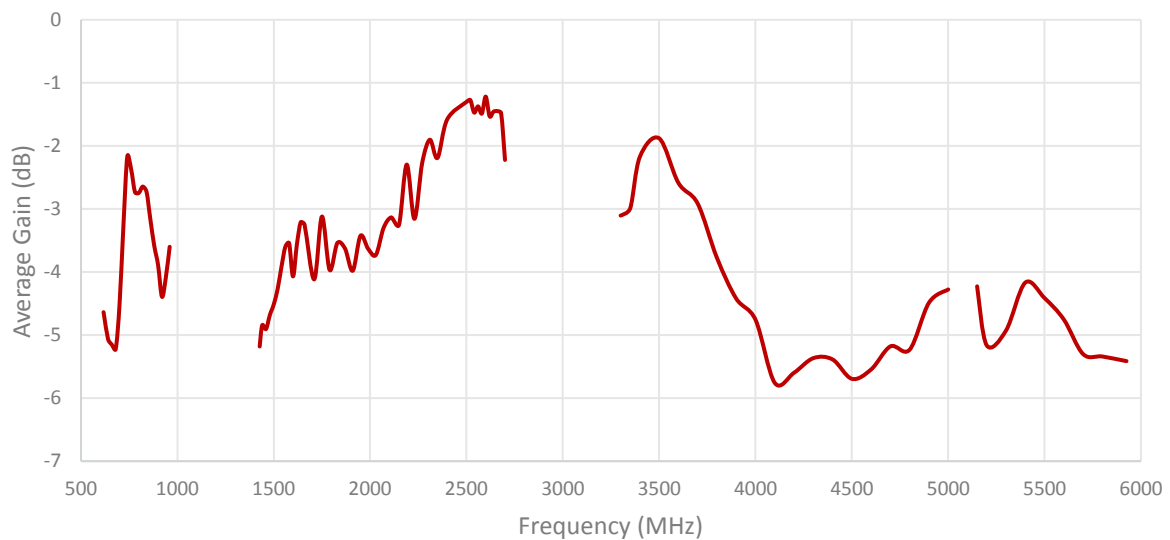
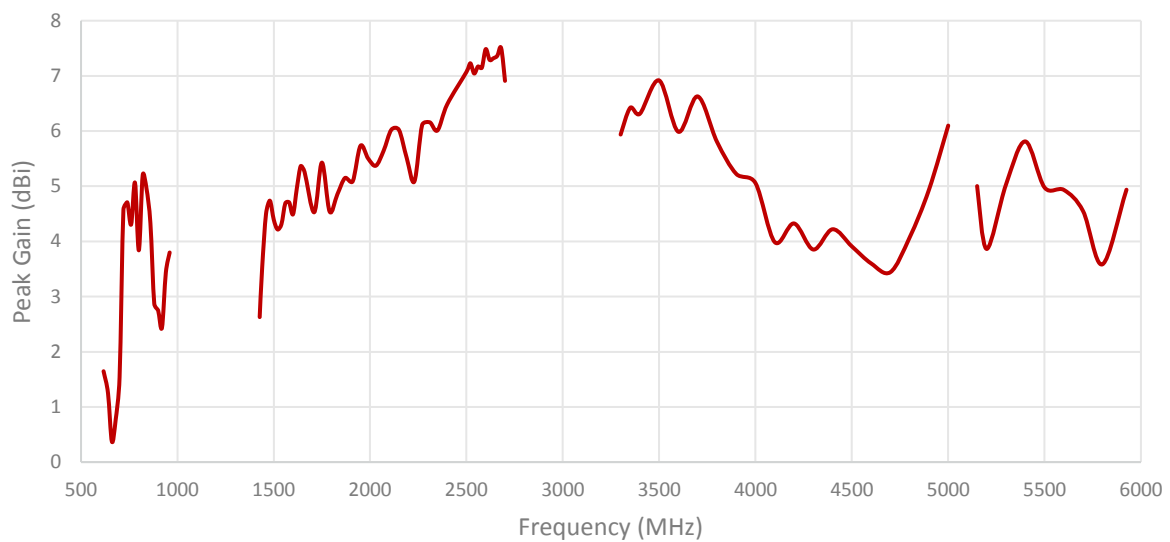
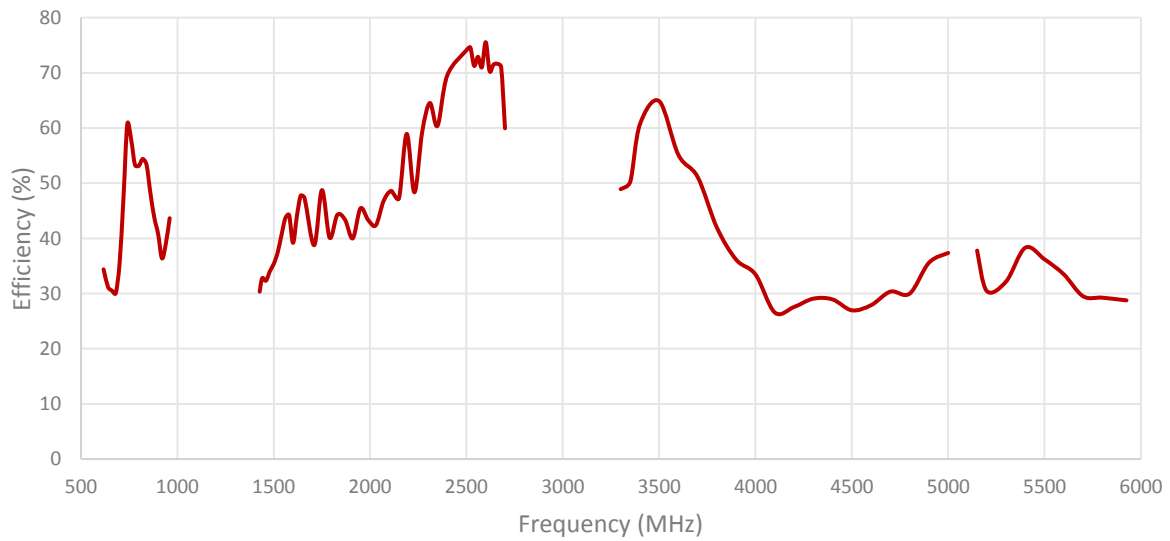



**ISOLATION FOR CABLES 1 AND 2**

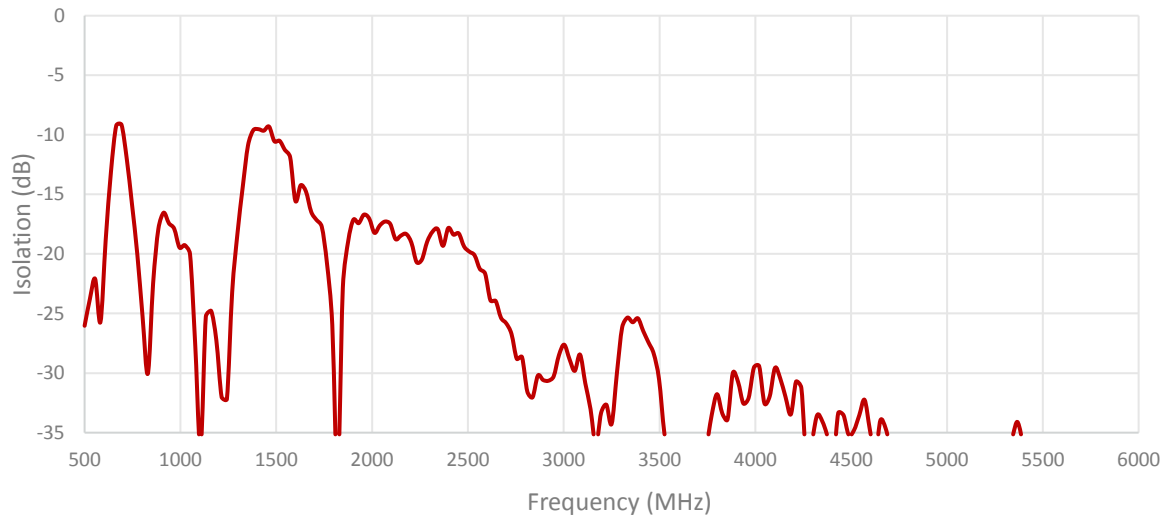

**ENVELOPE CORRELATION COEFFICIENT FOR CABLES 1 AND 2**

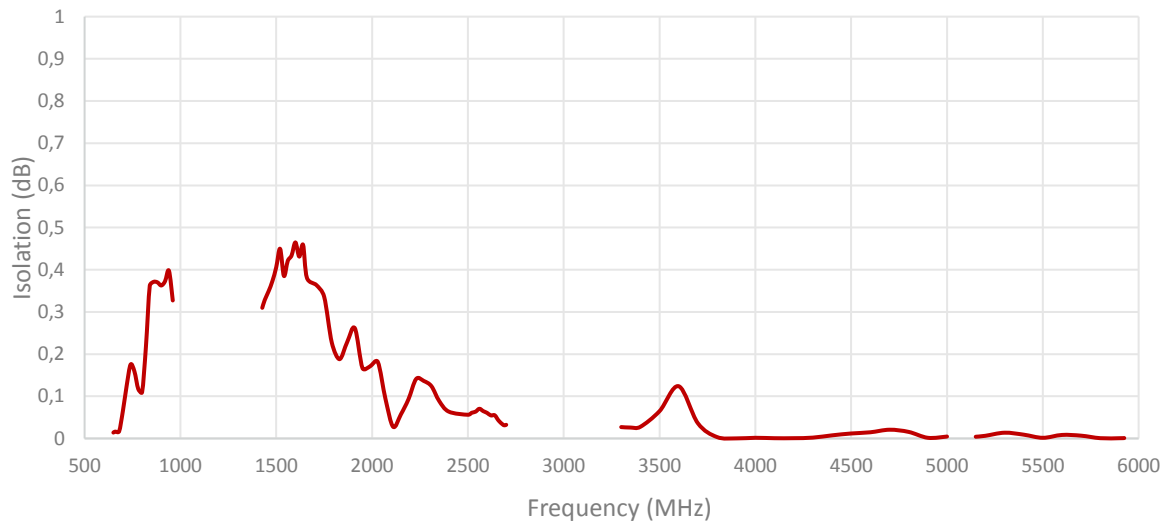

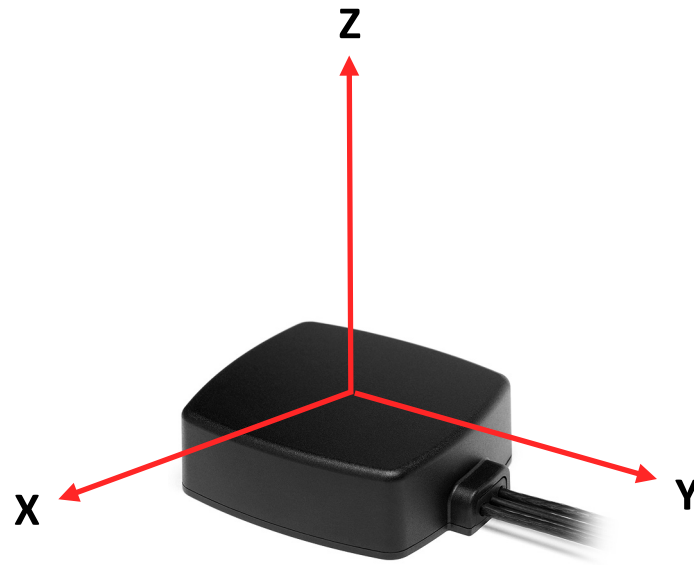

Radiation pattern reference

Cable 1: 5GNR

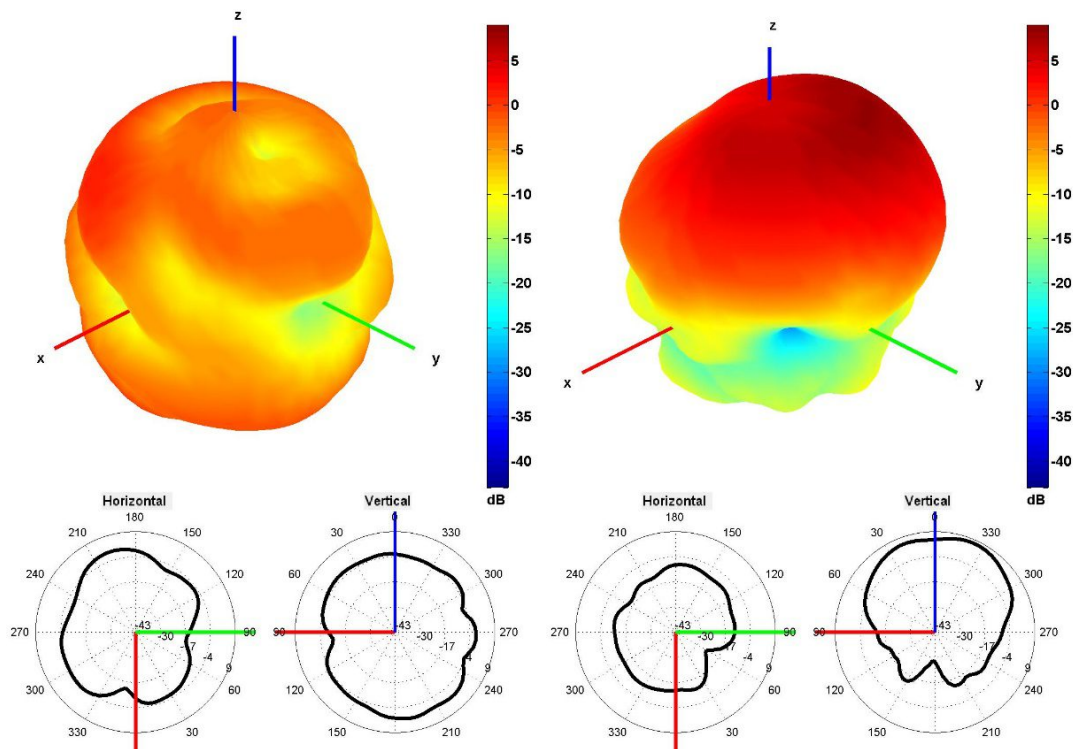

750 and 2500 MHz Radiation pattern

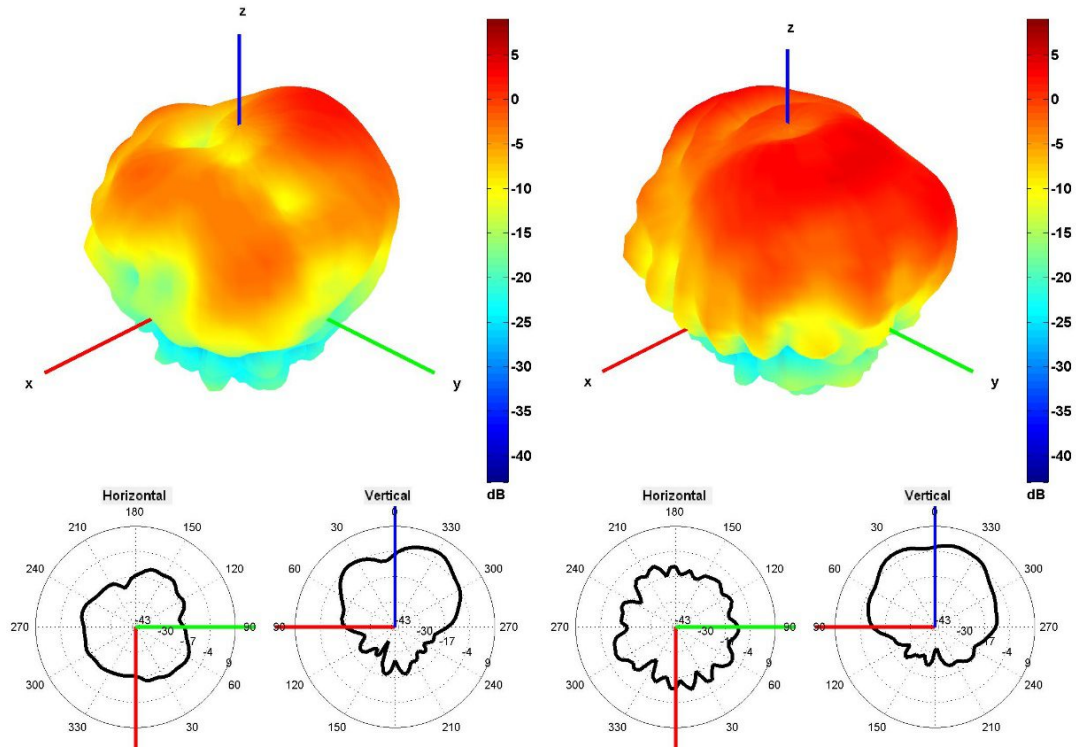

Cable 2: 5GNR

450 and 550 MHz Radiation pattern

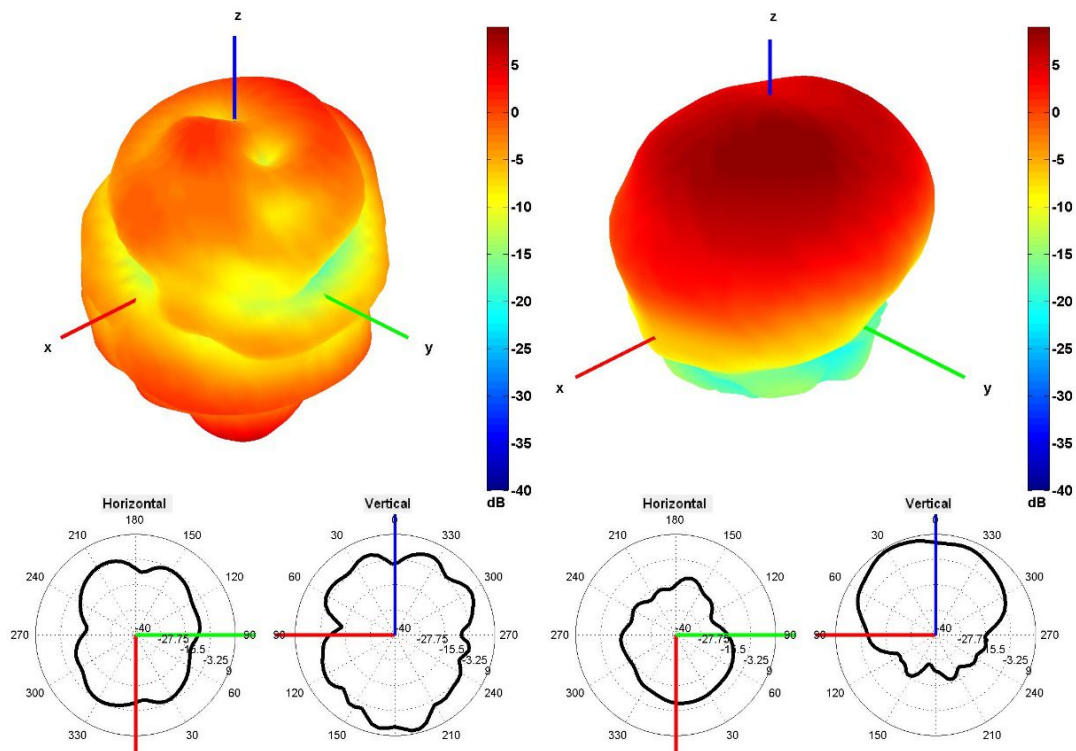

750 and 2500 MHz Radiation pattern

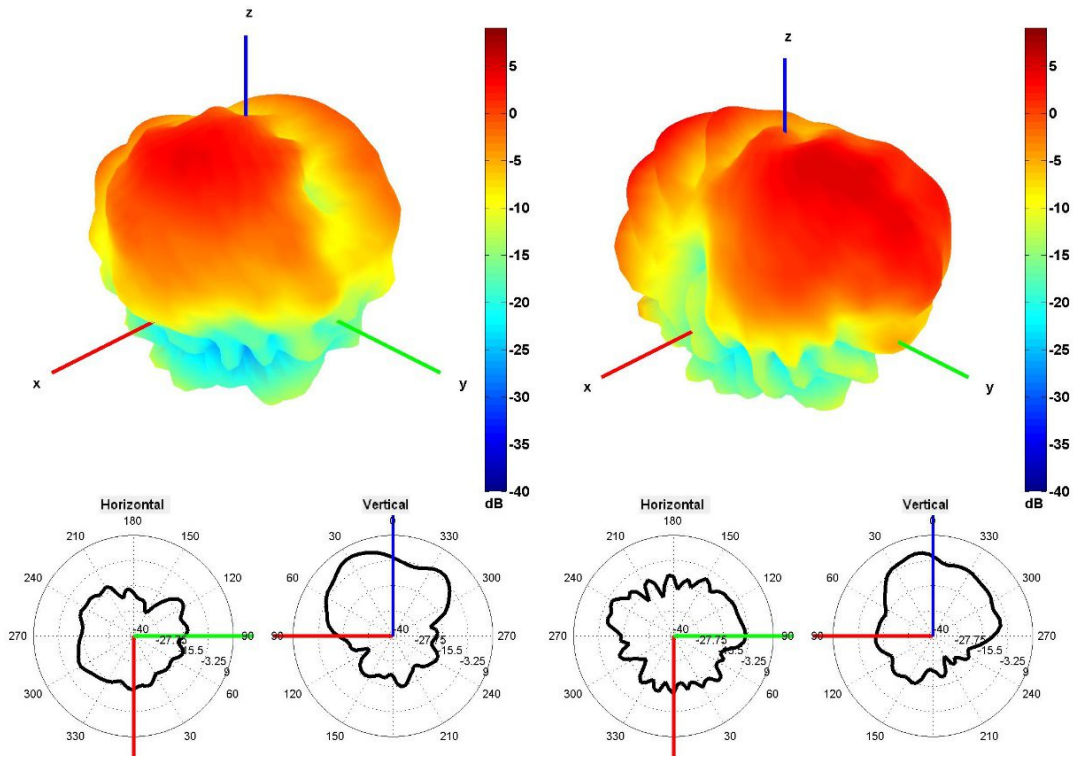

4500 and 5500 MHz Radiation pattern

## 4. Antenna drawings

### Magnetic Mount option

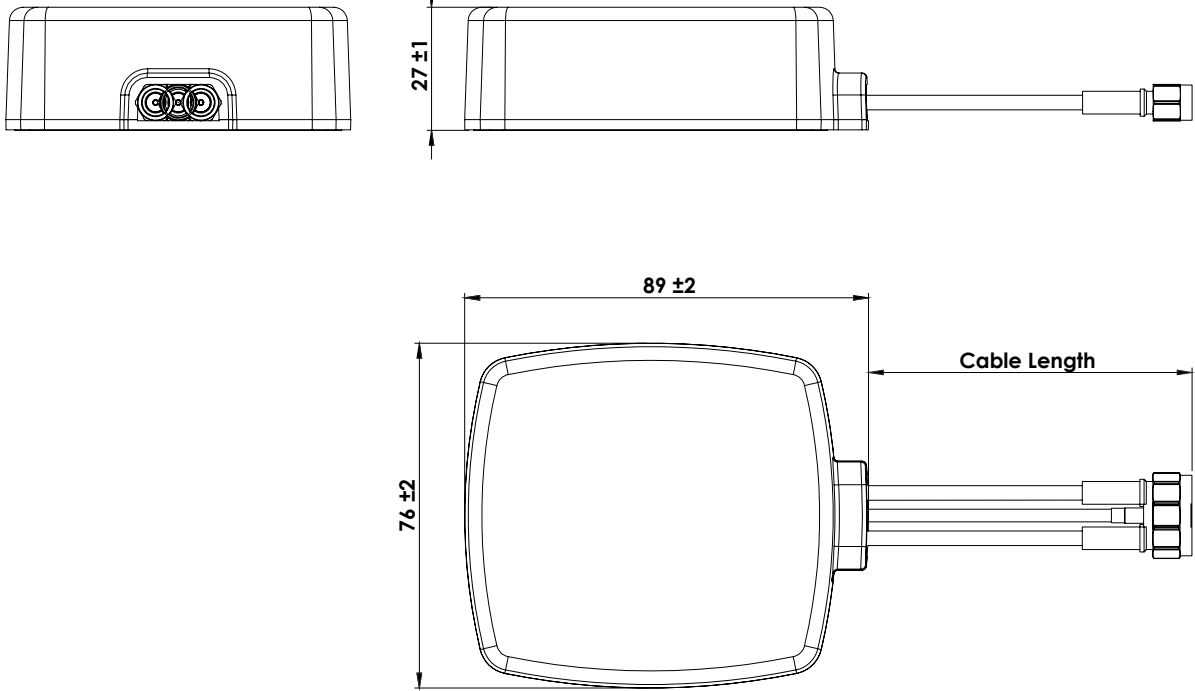

### Adhesive Mount option

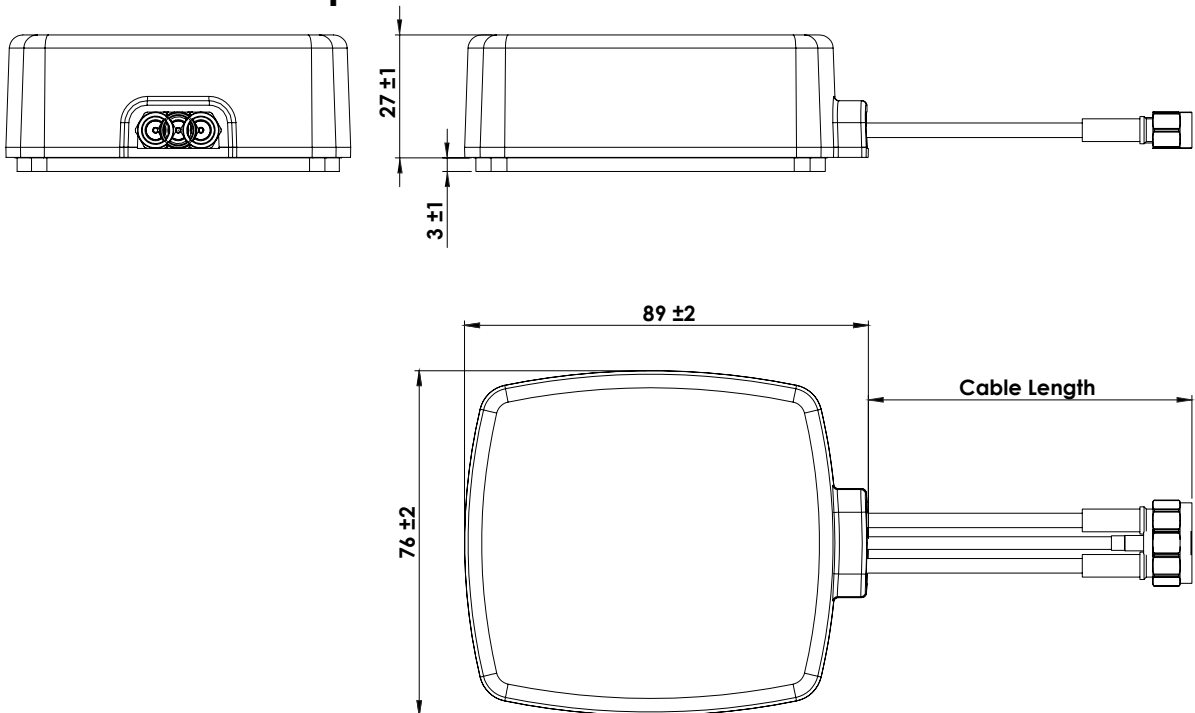

## 5. Antenna Images

