

QUINT-PS/3AC – 3-Phase DIN Rail Power Supply

 [perle.com/products/industrial-power-supply/quint-3-phase.shtml](https://www.perle.com/products/industrial-power-supply/quint-3-phase.shtml)

Robust with SFB (Selective Fuse Breaking) Technology & NFC

- Output Voltages: 24 or 48 V DC
- Adjustable Output Voltage Ranges: 18 to 56 V DC
- Output Amps: 10, 20 or 40 Amps
- Output Watts: 240, 480 or 960 W
- Will operate with 3-phase or 2-phase AC or DC input Voltage Ranges



QUINT 3-Phase Power Supplies offer a range of rugged AC to DC and DC to DC Converters built to meet the high stability and efficiency expectations of industrial, machine automation and process control environments. They also feature the unique combination of preventive function monitoring and power reserve in an incredibly compact size. Perfect for use in high power applications, these Switching (switch mode) Power Supplies ensure a regulated output voltage even in the event of voltage fluctuations in the power supply network. During parallel operation, and when connected to different phases, loads are reliably supplied even in the event of problems with the input voltage. With all required safety certifications to support ITE (Information Technology Equipment), ruggedized packaging, extended operating temperatures, high peak load capabilities and high isolation voltages, QUINT Industrial Power Supplies are designed to meet the needs of your industrial application.

POWER BOOST: reliably start difficult loads

A high degree of flexibility is required to configure, optimize and expand large systems. To optimally adapt a system or machine to your requirements, a power reserve in the power supply unit is crucial. The QUINT supplies up to 50% additional current without a voltage drop. This is useful when it is not possible to predict which loads will be switched on at the same time or high switch-on currents of capacitive loads have to be absorbed without voltage dips. With the QUINT Power Boost function a **static boost**

will continuously provide up to 125% of the nominal current. In addition, you can use the **dynamic boost to supply up to 200%** of the nominal current for 5 seconds when starting up heavy loads.

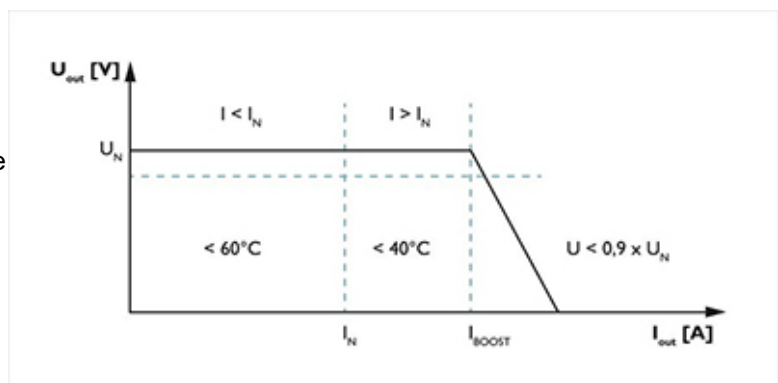

Preventive function monitoring reports critical operating states before they occur

With a QUINT Industrial Power Supply, the output voltage and output current are constantly monitored. Preventive function monitoring visualizes critical operating states and indicates them locally and remotely to the controller as follows:

- Via LED
- Via floating relay contact
- Via active switching output

Industrial operating temperature of -25°C to +70°C

Equipment found in traffic management, oil and gas pipelines, weather tracking, industrial and outdoor applications must function in temperatures that cannot be supported by a commercial power supplies. With an operating temperature of **-25°C to +70°C**, and **reliable device start-up at -40°C**, the QUINT Industrial Power Supply is ideal for use with equipment subjected to harsh environments and severe temperatures.

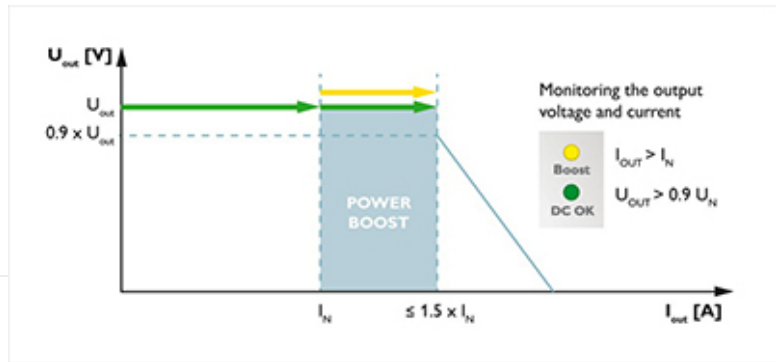

High efficiency and low no load power consumption

Compared with other products on the market, the QUINT Industrial Power Supply provides excellent energy savings. With a very low no load power consumption and high efficiency at nominal load, just a small amount of electrical energy is converted into undesired heat energy making these very ECO friendly power supplies.

SFB (Selective Fuse Breaking) Technology

SFB Technology can be used to quickly and reliably trip miniature circuit breakers and fuses connected on the secondary side. In the event of a short circuit on the secondary side, the QUINT supplies up to 6 times the nominal current for 15 ms. Faulty current paths are switched off selectively, the fault is located, and important system parts remain in operation. Loads that are connected in parallel are still supplied with energy ensuring continued operation of these system parts.

- Tripping circuit breakers: The circuit breaker is typically tripped by the high SFB current within 3 to 5 ms. As a result, any voltage dips for loads connected in parallel are avoided.
- Tripping a fuse: Fuses are tripped by melting the predetermined breaking point inside the fuse capsule. The tripping characteristic of the fuse is described by the melting integral (I^2t). A high current is crucial in order to achieve a very short tripping time.



Near Field Communication (NFC)

Near Field Communication (NFC) is a transmission standard for wireless and contactless data exchange at a close distance. With NFC, you can easily parameterize QUINT Power Supply settings such as define signaling thresholds for preventive function monitoring, adjust output voltage, and adapt the output characteristic curve to your specific requirements using a PC, mobile phone, or mobile terminal device. You can also save and send configuration profiles on your mobile terminal device. QUINT Power NFC



Ideal application environments for a QUINT 3-Phase Power Supply

- Drive motors and other devices
- Machine building
- Automated production process
- Industrial control, automation, assembly, and test equipment
- Building control, security and surveillance, and climate control systems.
- Power countless industrial automation devices such as sensors, controllers and valves

Other reasons to choose a QUINT 3-Phase Power Supply

- Robust input side: high noise immunity, integrated gas-filled surge arrester (up to 6 kV), and ≥ 20 ms mains failure buffer time
- Narrow, slim-line design saves space in the control box
- Voltage Isolation input/output: 4 kV AC
- Protections: Short-circuit, Overload, Over voltage, Over-temperature
- High MTBF (Mean Time Between Failure) values

	23208278	28668028	29046218	29046228
Environmental Product Compliance				
REACH SVHC	Lead 7439-92-1	Lead 7439-92-1	Lead 7439-92-1	Lead 7439-92-1
China RoHS	Environmentally Friendly Use Period = 25;	Environmentally Friendly Use Period = 25;	Environmentally Friendly Use Period = 25;	Environmentally Friendly Use Period = 25;
General				
Net weight	2.5 kg	2.5 kg	0.9 kg	1.1 kg
Efficiency	> 93 % (at 400 V AC and nominal values)	> 94 % (at 400 V AC and nominal values)	typ. 93 % (400 V AC)	typ. 93.9 % (400 V AC)
Insulation voltage input/output	4 kV AC (type test)	4 kV AC (type test)	4 kV AC (type test)	4 kV AC (type test)
	2 kV AC (routine test)	2 kV AC (routine test)	2.4 kV AC (routine test)	2.4 kV AC (routine test)
Insulation voltage input / PE	3.5 kV AC (type test)	3.5 kV AC (type test)	3.5 kV AC (type test)	3.5 kV AC (type test)
	2 kV AC (routine test)	2 kV AC (routine test)	2.4 kV AC (routine test)	2.4 kV AC (routine test)
Insulation voltage output / PE	500 V DC (routine test)	500 V DC (routine test)	0.5 kV DC (type test)	0.5 kV DC (type test)
Protection class	I	I	I	I
Degree of protection	IP20	IP20	IP20	IP20

MTBF (IEC 61709, SN 29500)	889679,72 h (25 °C)	> 880000 h (25 °C)	> 1034000 h (25 °C)	> 985000 h (25 °C)
	501504,51 h (40 °C)	> 500000 h (40 °C)	> 654000 h (40 °C)	> 638000 h (40 °C)
	216825,67 h (60 °C)	> 216000 s (60 °C)	> 320000 h (60 °C)	> 311000 h (60 °C)
Mounting position	horizontal DIN rail NS 35, EN 60715	horizontal DIN rail NS 35, EN 60715	horizontal DIN rail NS 35, EN 60715	horizontal DIN rail NS 35, EN 60715
Assembly instructions	alignable: P _N ≥50%, 5 mm horizontally, 15 mm next to active components, 50 mm vertically alignable: P _N <50%, 0 mm horizontally, 40 mm vertically top, 20 mm vertically bottom	alignable: P _N ≥50%, 5 mm horizontally, 15 mm next to active components, 50 mm vertically alignable: P _N <50%, 0 mm horizontally, 40 mm vertically top, 20 mm vertically bottom	alignable: P _N ≥50%, 5 mm horizontally, 15 mm next to active components, 50 mm vertically alignable: P _N <50%, 0 mm horizontally, 40 mm vertically top, 20 mm vertically bottom	alignable: P _N ≥50%, 5 mm horizontally, 15 mm next to active components, 50 mm vertically alignable: P _N <50%, 0 mm horizontally, 40 mm vertically top, 20 mm vertically bottom
Operating voltage display	Green LED			
Efficiency			typ. 92.6 % (480 V AC)	typ. 93.8 % (480 V AC)
Insulation voltage output / PE			0.5 kV DC (routine test)	0.5 kV DC (routine test)
Standards and Regulations				
Electromagnetic compatibility	Conformance with EMC Directive 2014/30/EU	Conformance with EMC Directive 2014/30/EU	Conformance with EMC Directive 2014/30/EU	Conformance with EMC Directive 2014/30/EU
Noise immunity	EN 61000-6-2:2005	EN 61000-6-2:2005	Immunity according to EN 61000-6-1 (residential), EN 61000-6-2 (industrial), and EN 61000-6-5 (power station equipment zone), IEC/EN 61850-3 (energy supply)	Immunity according to EN 61000-6-1 (residential), EN 61000-6-2 (industrial), and EN 61000-6-5 (power station equipment zone), IEC/EN 61850-3 (energy supply)
Connection in acc. with standard	CSA	CSA		
Standards/regulations	EN 61000-4-2	EN 61000-4-2	EN 61000-4-2	EN 61000-4-2

Contact discharge	4 kV (Test Level 2)	4 kV (Test Level 2)	4 kV (Test Level 2)	4 kV (Test Level 2)
Standards/regulations	EN 61000-4-3	EN 61000-4-3	EN 61000-4-3	EN 61000-4-3
Frequency range	80 MHz ... 1 GHz	80 MHz ... 1 GHz	80 MHz ... 1 GHz	80 MHz ... 1 GHz
Test field strength	10 V/m (Test Level 3)	10 V/m (Test Level 3)	10 V/m (Test Level 3)	10 V/m (Test Level 3)
Frequency range	1.4 GHz ... 2 GHz	1.4 GHz ... 2 GHz	1.4 GHz ... 2 GHz	1.4 GHz ... 2 GHz
Test field strength	3 V/m (Test Level 2)	3 V/m (Test Level 2)	3 V/m (Test Level 2)	3 V/m (Test Level 2)
Standards/regulations	EN 61000-4-4	EN 61000-4-4	EN 61000-4-4	EN 61000-4-4
Comments	Criterion B	Criterion B	Criterion B	Criterion B
Standards/regulations	EN 61000-4-6	EN 61000-6-3	EN 61000-4-6	EN 61000-4-6
Frequency range	0.15 MHz ... 80 MHz	0.15 MHz ... 80 MHz	0.15 MHz ... 80 MHz	0.15 MHz ... 80 MHz
Voltage	10 V (Test Level 3)	10 V (Test Level 3)	10 V (Test Level 3)	10 V (Test Level 3)
Low Voltage Directive	Conformance with LV directive 2006/95/EC	Conformance with LV directive 2006/95/EC	Conformance with Low Voltage Directive 2014/35/EC	Conformance with Low Voltage Directive 2014/35/EC
Standard - Safety of transformers	IEC 61558-2-17		EN 61558-2-16 (air clearances and creepage distances only)	EN 61558-2-16 (air clearances and creepage distances only)
Standard - Electrical safety	IEC 60950-1/VDE 0805 (SELV)	IEC 60950-1/VDE 0805 (SELV)	IEC 60950-1/VDE 0805 (SELV)	IEC 60950-1/VDE 0805 (SELV)
Standard – Electronic equipment for use in electrical power installations and their assembly into electrical power installations	EN 50178/VDE 0160 (PELV)	EN 50178/VDE 0160 (PELV) / Overvoltage category III	EN 50178/VDE 0160 (PELV)	EN 50178/VDE 0160 (PELV)
Standard – Safety extra-low voltage	IEC 60950-1 (SELV) and EN 60204-1 (PELV)	IEC 60950-1 (SELV) and EN 60204-1 (PELV)	IEC 60950-1 (SELV) and EN 60204-1 (PELV)	IEC 60950-1 (SELV) and EN 60204-1 (PELV)
Standard - Safe	DIN VDE 0100-410	DIN VDE 0100-410	DIN VDE 0100-410	DIN VDE 0100-410

Standard – Protection against shock currents, basic requirements for protective separation in electrical equipment	EN 50178			
Standard – Limitation of mains harmonic currents	EN 61000-3-2	EN 61000-3-2	EN 61000-3-2	EN 61000-3-2
Standard - Equipment safety	BG (design tested)	GS (tested safety)		
Standard - Approval for medical use	IEC 60601-1, 2 x MOOP			
UL approvals	UL Listed UL 508	UL Listed UL 508	UL Listed UL 508	UL Listed UL 508
	UL/C-UL Recognized UL 60950-1 (3-wire + PE, star net)	UL/C-UL Recognized UL 60950-1 (3-wire + PE, star net)	UL/C-UL Recognized UL 60950-1	UL/C-UL Recognized UL 60950-1
	UL ANSI/ISA-12.12.01 Class I, Division 2, Groups A, B, C, D (Hazardous Location)	UL ANSI/ISA-12.12.01 Class I, Division 2, Groups A, B, C, D (Hazardous Location)	UL ANSI/ISA-12.12.01 Class I, Division 2, Groups A, B, C, D (Hazardous Location)	UL ANSI/ISA-12.12.01 Class I, Division 2, Groups A, B, C, D (Hazardous Location)
Shock	18 ms, 30g, in each space direction (according to IEC 60068-2-27)	18 ms, 30g, in each space direction (according to IEC 60068-2-27)	18 ms, 30g, in each space direction (according to IEC 60068-2-27)	18 ms, 30g, in each space direction (according to IEC 60068-2-27)
Vibration (operation)	< 15 Hz, amplitude ± 2.5 mm (according to IEC 60068-2-6)	5 Hz ... 100 Hz resonance search 2.3g, 90 min., resonance frequency 2.3g, 90 min. (according to DNV GL Class C)	5 Hz ... 100 Hz resonance search 2.3g, 90 min., resonance frequency 2.3g, 90 min. (according to DNV GL Class C)	5 Hz ... 100 Hz resonance search 2.3g, 90 min., resonance frequency 2.3g, 90 min. (according to DNV GL Class C)
	15 Hz ... 150 Hz, 2.3g, 90 min.			
Information technology equipment - safety (CB scheme)	CB Scheme	CB Scheme		

Overvoltage category (EN 62477-1)	III	III	III (≤ 2000 m)	III (≤ 2000 m)
Standards/regulations		EN 61000-4-6	EN 61000-4-8	EN 61000-4-8
Standard - Safe isolation		DIN VDE 0106-101		
Shipbuilding approval		DNV GL (EMC A), ABS, LR, RINA, NK, BV	DNV GL, PRS, BV, LR, ABS	DNV GL, PRS, BV, LR, ABS
Noise emission			Additional basic standard EN 61000-6-5 (immunity in power station), IEC/EN 61850-3 (energy supply)	Additional basic standard EN 61000-6-5 (immunity in power station), IEC/EN 61850-3 (energy supply)
Conducted noise emission			EN 55016 EN 61000-6-4 (Class A)	EN 55016 EN 61000-6-4 (Class A)
Standards/regulations			EN 61000-4-11	EN 61000-4-11
			EN 61000-4-9	EN 61000-4-9
			EN 61000-4-12	EN 61000-4-12
			EN 61000-4-16	EN 61000-4-16
			EN 61000-4-18	EN 61000-4-18
Standard - power supply devices for low voltage with DC output			EN 61204-3	EN 61204-3
EMC requirements, power plant			IEC 61850-3	
			EN 61000-6-5	
Approval - requirement of the semiconductor industry with regard to mains voltage dips			SEMI F47-0706; EN 61000-4-11	SEMI F47-0706; EN 61000-4-11
Overvoltage category (EN 60950-1)			II (≤ 5000 m)	II (≤ 5000 m)
Overvoltage category (EN 61010-1)			II (≤ 5000 m)	II (≤ 5000 m)
Connection data, input				
Connection method	Screw connection	Screw connection	Screw connection	Screw connection

Conductor cross section solid min.	0.2 mm ²	0.2 mm ²	0.2 mm ²	0.2 mm ²
Conductor cross section solid max.	6 mm ²	6 mm ²	6 mm ²	6 mm ²
Conductor cross section flexible min.	0.2 mm ²	0.2 mm ²	0.2 mm ²	0.2 mm ²
Conductor cross section flexible max.	4 mm ²	4 mm ²	4 mm ²	4 mm ²
Conductor cross section AWG min.	18	18	30	30
Conductor cross section AWG max.	10	10	10	10
Stripping length	7 mm	7 mm	8 mm	8 mm
Screw thread	M3	M3		
Output data				
Nominal output voltage	48 V DC ±1 %	24 V DC ±1 %	24 V DC	24 V DC
Setting range of the output voltage (U _{Set})	30 V DC ... 56 V DC (> 48 V DC, constant capacity restricted)	18 V DC ... 29.5 V DC (> 24 V DC, constant capacity restricted)	24 V DC ... 29.5 V DC (constant capacity)	24 V DC ... 29.5 V DC (constant capacity)
Nominal output current (I _N)	20 A (-25 °C ... 60 °C, U _{OUT} = 48 V DC)	40 A (-25 °C ... 60 °C, U _{OUT} = 24 V DC)	10 A	20 A
POWER BOOST (I _{Boost})	22.5 A (-25°C ... 40°C permanent, U _{OUT} = 48 V DC)	45 A (-25°C ... 40°C permanent, U _{OUT} = 24 V DC)		
Selective Fuse Breaking (I _{SFB})	100 A (12 ms)	215 A (12 ms)	60 A (15 ms)	120 A (15 ms)
Derating	60 °C ... 70 °C (2.5%/K)	60 °C ... 70 °C (2.5%/K)	> 60 °C (2.5%/K)	> 60 °C (2.5%/K)
Connection in parallel	Yes, for redundancy and increased capacity	Yes, for redundancy and increased capacity	Yes, for redundancy and increased capacity	Yes, for redundancy and increased capacity
Connection in series	yes	yes	yes	yes
Feedback resistance	max. 60 V DC	max. 35 V DC	≤ 35 V DC	≤ 35 V DC

Protection against surge voltage on the output	< 60 V DC	< 35 V DC	≤ 32 V DC	≤ 32 V DC
Active current limitation	Approx. $I_{\text{BOOST}} = 22.5 \text{ A}$ (for short-circuit)			
Control deviation	< 1 % (change in load, static 10 % ... 90 %)	< 1 % (change in load, static 10 % ... 90 %)	< 0.5 % (Static load change 10 % ... 90 %)	< 0.5 % (Static load change 10 % ... 90 %)
	< 4 % (change in load, dynamic 10 % ... 90 %)	< 3 % (change in load, dynamic 10 % ... 90 %)	< 2 % (Dynamic load change 10 % ... 90 %, (10 Hz))	< 3 % (Dynamic load change 10 % ... 90 %, (10 Hz))
	< 0.1 % (change in input voltage ±10 %)	< 0.1 % (change in input voltage ±10 %)	< 0.25 % (change in input voltage ±10 %)	< 0.25 % (change in input voltage ±10 %)
Residual ripple	< 50 mV _{PP} (with nominal values)	< 40 mV _{PP} (with nominal values)	< 75 mV _{PP} (with nominal values)	< 60 mV _{PP} (with nominal values)
Output power	960 W	960 W	240 W	480 W
Typical response time	< 1 s	< 0.5 s	300 ms (from SLEEP MODE)	300 ms (from SLEEP MODE)
Maximum power dissipation in no-load condition	24 W	18 W	< 5 W (400 V AC)	< 7 W (400 V AC)
Power loss nominal load max.	70 W	63 W	< 19 W (400 V AC)	< 32 W (400 V AC)
Peak switching voltages nominal load		< 5 mV _{PP} (at nominal values, 20 MHz)		
Static Boost ($I_{\text{Stat.Boost}}$)			12.5 A	25 A
Dynamic Boost ($I_{\text{Dyn.Boost}}$)			20 A (5 s)	30 A (5 s)
Maximum power dissipation in no-load condition			< 5 W (480 V AC)	< 7 W (480 V AC)
Power loss nominal load max.			< 20 W (480 V AC)	< 33 W (480 V AC)
Connection data for signaling				
Conductor cross	0.2 mm ²	0.2 mm ²	0.2 mm ²	0.2 mm ²

Conductor cross section solid max.	6 mm ²	6 mm ²	1.5 mm ²	1.5 mm ²
Conductor cross section flexible min.	0.2 mm ²	0.2 mm ²	0.2 mm ²	0.2 mm ²
Conductor cross section flexible max.	4 mm ²	4 mm ²	1.5 mm ²	1.5 mm ²
Conductor cross section AWG min.	18	18	24	24
Conductor cross section AWG max.	10	10	16	16
Screw thread	M3	M3		
Connection method			Push-in connection	Push-in connection
Stripping length			8 mm	8 mm
Dimensions				
Width	96 mm	96 mm	50 mm	70 mm
Height	130 mm	130 mm	130 mm	130 mm
Depth	179 mm	176 mm	125 mm	125 mm
Width with alternative assembly	176 mm	176 mm	122 mm	122 mm
Height with alternative assembly	130 mm	130 mm	130 mm	130 mm
Depth with alternative assembly	99 mm	99 mm	53 mm	73 mm
Weight per piece	2500.0 GRM	2954.0 GRM	1000.0 GRM	1516.8 GRM
Input data				
Nominal input voltage range	3x 400 V AC ... 500 V AC	3x 400 V AC ... 500 V AC	3x 400 V AC ... 500 V AC	3x 400 V AC ... 500 V AC
Input voltage range	3x 320 V AC ... 575 V AC	3x 320 V AC ... 575 V AC	3x 400 V AC ... 500 V AC -20 % ... +10 %	3x 400 V AC ... 500 V AC -20 % ... +10 %
	2x 360 V AC ... 575 V AC (Not approved by UL)	2x 360 V AC ... 575 V AC	2x 400 V AC ... 500 V AC -10 % ... +10 %	2x 400 V AC ... 500 V AC -10 % ... +10 %
	450 V DC ... 800 V DC	450 V DC ... 800 V DC	± 260 V DC ... 300 V DC -13 % ... +30 %	± 260 V DC ... 300 V DC -13 % ... +30 %
AC frequency range	45 Hz ... 65 Hz	45 Hz ... 65 Hz	50 Hz ... 60 Hz -10 % ... +10 %	50 Hz ... 60 Hz -10 % ... +10 %

Frequency range DC	0 Hz	0 Hz		
Discharge current to PE	< 3.5 mA	< 3.5 mA	< 3.5 mA	< 3.5 mA
Current consumption	3x 2.1 A (400 V AC)	3x 2.1 A (400 V AC)	3x 0.5 A (400 V AC)	3x 0.99 A (400 V AC)
	3x 1.7 A (500 V AC)	3x 1.7 A (500 V AC)	3x 0.41 A (480 V AC)	3x 0.81 A (480 V AC)
	1.7 A (600 V DC)	1.7 A (600 V DC)	2x 1.1 A (400 V AC)	2x 1.62 A (400 V AC)
Nominal power consumption	1386 VA	1342 VA	274 VA	541 VA
Inrush surge current	< 20 A (typical)	< 15 A	typ. 3 A (at 25 °C)	typ. 2 A (at 25 °C)
Mains buffering	typ. 25 ms (400 V AC)	> 25 ms (400 V AC)	typ. 29 ms (3x 400 V AC)	typ. 33 ms (3x 400 V AC)
	typ. 35 ms (500 V AC)	> 35 ms (500 V AC)	typ. 26 ms (3x 480 V AC)	typ. 33 ms (3x 480 V AC)
Choice of suitable circuit breakers	6 A ... 16 A (AC: Characteristics B, C, D, K)	6 A ... 16 A (AC: Characteristics B, C, D, K)	3x 4 A ... 20 A (Characteristic B, C or comparable)	3x 4 A ... 20 A (Characteristic B, C or comparable)
Type of protection	Transient surge protection	Transient surge protection	Transient surge protection	Transient surge protection
Protective circuit/component	Varistor	Varistor, gas-filled surge arrester	Varistor, gas-filled surge arrester	Varistor, gas-filled surge arrester
Nominal input voltage range			2x 400 V AC ... 500 V AC	2x 400 V AC ... 500 V AC
			± 260 V DC ... 300 V DC	± 260 V DC ... 300 V DC
Current consumption			2x 0.91 A (480 V AC)	2x 1.37 A (480 V AC)
			3x 0.4 A (500 V AC)	3x 0.8 A (500 V AC)
			2x 1.1 A (500 V AC)	2x 1.23 A (500 V AC)
Connection data, output				
Conductor cross section solid min.	0.2 mm ²	0.2 mm ²	0.2 mm ²	0.2 mm ²
Conductor cross section solid max.	6 mm ²	6 mm ²	1.5 mm ²	1.5 mm ²
Conductor cross section flexible min.	0.2 mm ²	0.2 mm ²	0.2 mm ²	0.2 mm ²

Conductor cross section flexible max.	4 mm ²	4 mm ²	1.5 mm ²	1.5 mm ²
Conductor cross section AWG min.	18	18	24	24
Conductor cross section AWG max.	10	10	16	16
Screw thread	M3	M3		
Connection method			Push-in connection	Push-in connection
Stripping length			8 mm	8 mm
Screw thread	M3	M4		
Ambient conditions				
Degree of protection	IP20	IP20	IP20	IP20
Ambient temperature (operation)	-25 °C ... 70 °C (> 60 °C Derating: 2.5 %/K)	-25 °C ... 70 °C (> 60 °C Derating: 2.5 %/K)	-25 °C ... 70 °C (> 60 °C Derating: 2.5 %/K)	-25 °C ... 70 °C (> 60 °C Derating: 2.5 %/K)
Ambient temperature (start-up type tested)	-40 °C	-40 °C	-40 °C	-40 °C
Ambient temperature (storage/transport)	-40 °C ... 85 °C	-40 °C ... 85 °C	-40 °C ... 85 °C	-40 °C ... 85 °C
Max. permissible relative humidity (operation)	≤ 95 % (at 25 °C, non-condensing)	≤ 95 % (at 25 °C, non-condensing)	≤ 95 % (at 25 °C, non-condensing)	≤ 95 % (at 25 °C, non-condensing)
Climatic class	3K3 (in acc. with EN 60721)	3K3 (in acc. with EN 60721)	3K3 (in acc. with EN 60721)	3K3 (in acc. with EN 60721)
Degree of pollution	2	2	2	2
Installation height	4000 m	4000 m	≤ 5000 m (> 2000 m, observe derating)	≤ 5000 m (> 2000 m, observe derating)

Approvals

- ABS
- DNV GL
- BV
- cCSAus
- SEMI F47
- RINA
- cUL Recognized
- cUL Listed
- LR
- UL Listed
- IEC/CE CB Scheme
- cULus Listed
- UL Recognized
- EAC
- cULus Recognized
- NK
- CSA
- Bauartgeprüft
- CSAus

QUINT-PS/3AC Industrial Power Supply Block Diagram

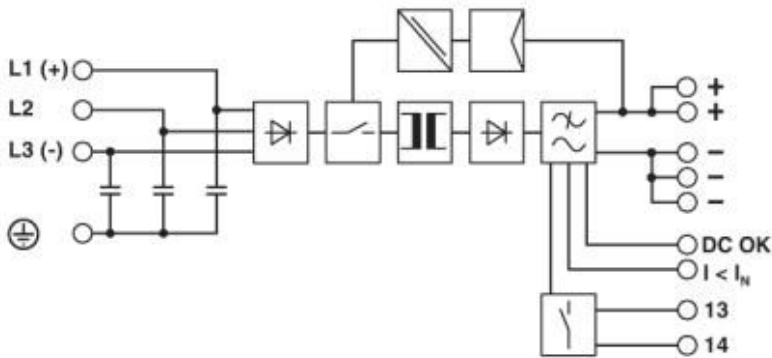

QUINT4-PS/3AC/24DC Industrial Power Supply Block Diagram

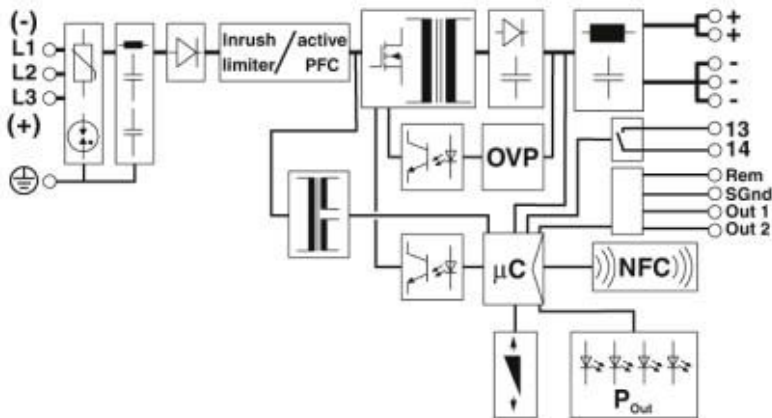

Schematic diagram

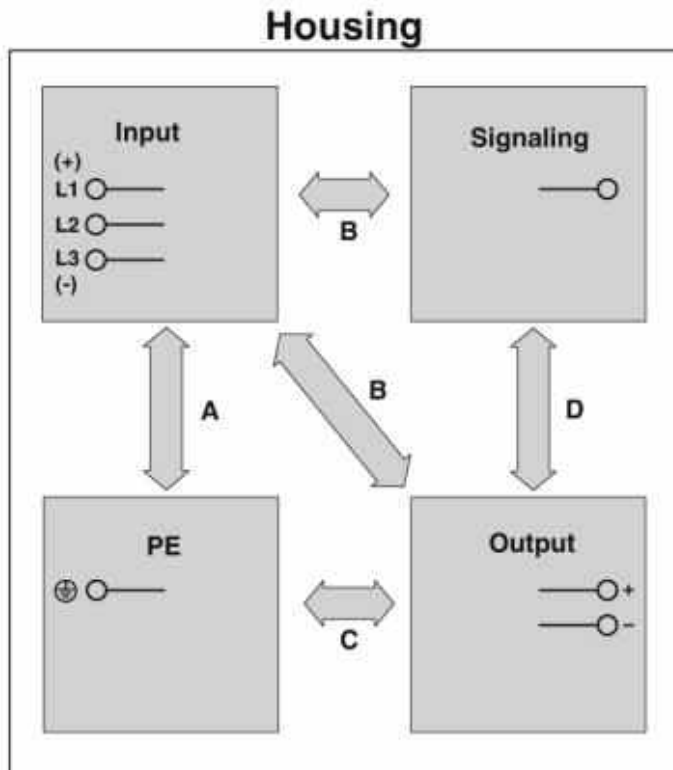

QUINT4-PS/3AC/24DC/10 Input current vs output current

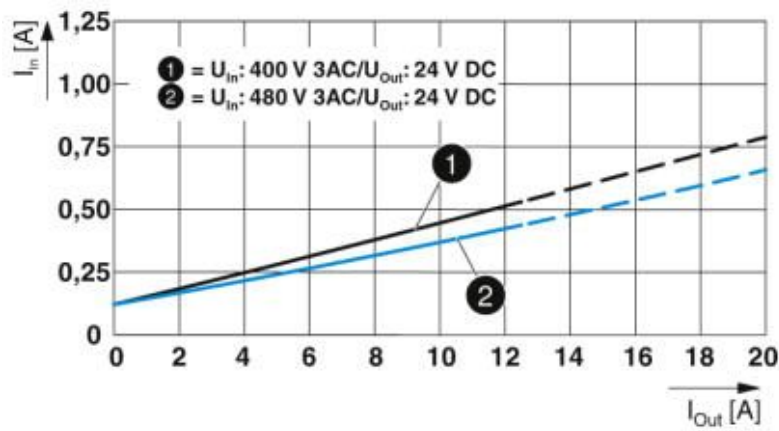

QUINT4-PS/3AC/24DC/20 Input current vs output current



QUINT4-PS/3AC/24DC/10 Power factor diagram

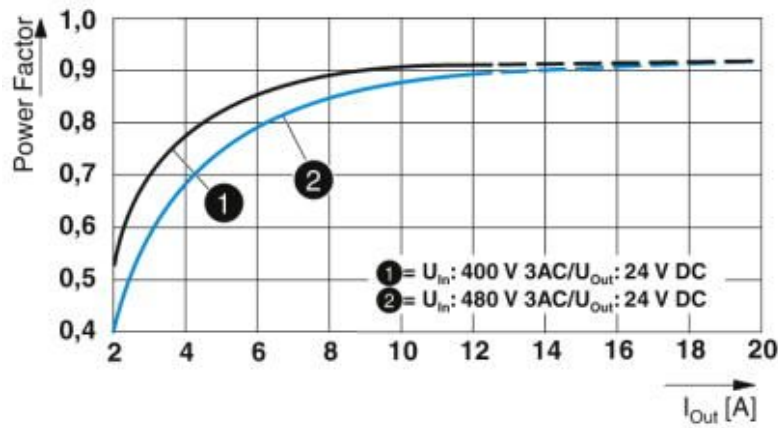

QUINT4-PS/3AC/24DC/20 Power factor diagram

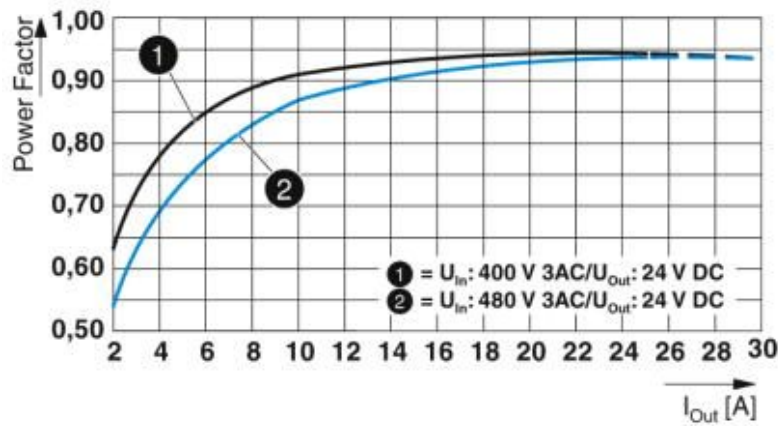

QUINT4-PS/3AC/24DC/10 Efficiency diagram

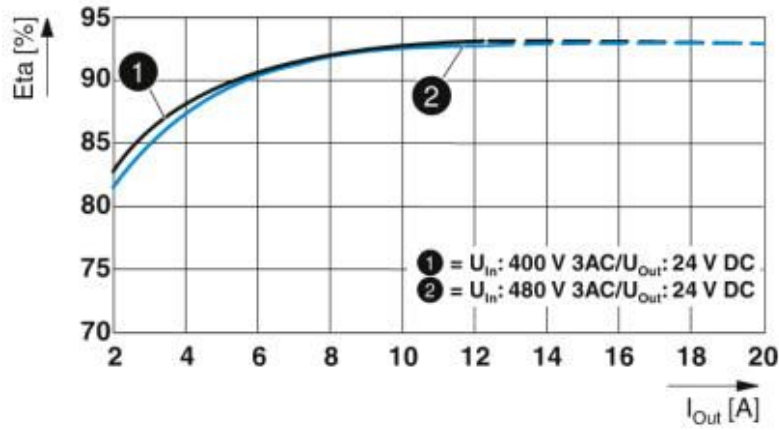

QUINT4-PS/3AC/24DC/20 Efficiency diagram

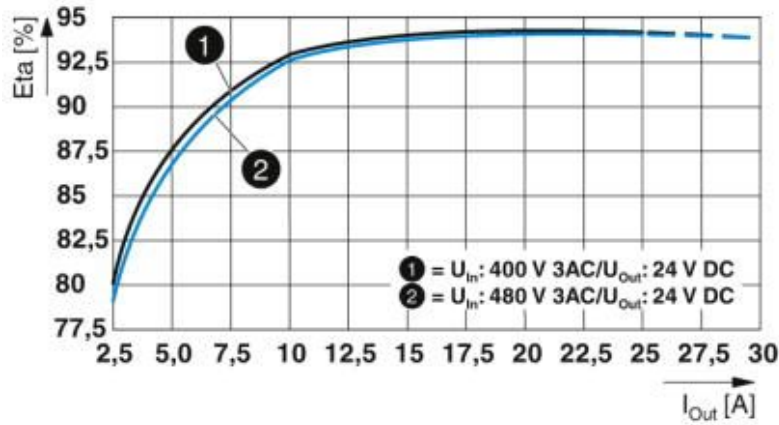



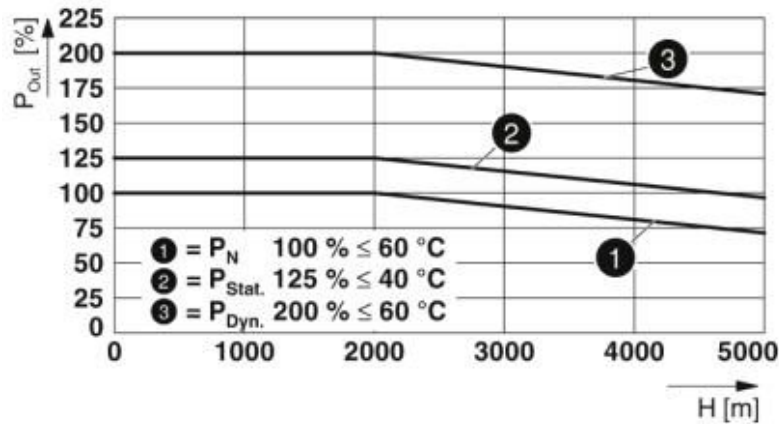

QUINT4-PS/3AC/24DC/10 Output power depending on the installation height

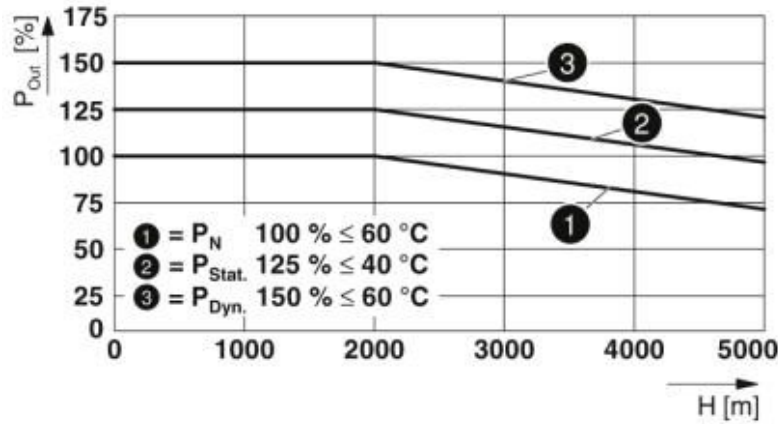

QUINT4-PS/3AC/24DC/20 Output power depending on the installation height



Part Number	Product Name	3-Phase Input Voltage Range (V AC)	2-Phase Input Voltage Range (V AC)	Input Voltage Range (V DC)	Output Voltage (V DC)	Output Range (V DC)	Output Current (Amps)	Output Power (Watts)	Dimensions (W x H x D)	Additional Features
 29046218	QUINT4-PS/3AC/24DC/10	320 ... 550	360 ... 550	± 226 ... 390	24	24 ... 29.5	10	240	50 x 130 x 125	NFC Technology Shipbuilding Approvals
 29046228	QUINT4-PS/3AC/24DC/20	320 ... 550	360 ... 550	± 226 ... 390	24	24 ... 29.5	20	480	70 x 130 x 125	NFC Technology Shipbuilding Approvals
 28668028	QUINT-PS/3AC/24DC/40	320 ... 575	360 ... 575	450 ... 800	24	18 ... 29.5	40	960	96 x 130 x 176	-
 23208278	QUINT-PS/3AC/48DC/20	320 ... 575	360 ... 575	450 ... 800	48	30 ... 56	20	960	96 x 130 x 179	-