

Datasheet

50 mm Compact IO-Link Controlled Multicolor RGB Audible Indicator

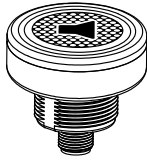

- Bright, uniform indicator light
- Designed with integrated audible alarm
- Available for lower profile applications
- 14 standard colors plus custom color options
- IO-Link control allows access to full color, flashing, and dimming settings, as well as advanced animations and audible tones
- 30 mm threaded polycarbonate base
- Translucent polycarbonate cover
- Rugged IP67, IP69K per DIN 40050-9 and UL Type 4X and UL Type 13 design
- Variety of connector options
- 14 different tones available including intensity control
- Two model options - with or without RGB indication

Models

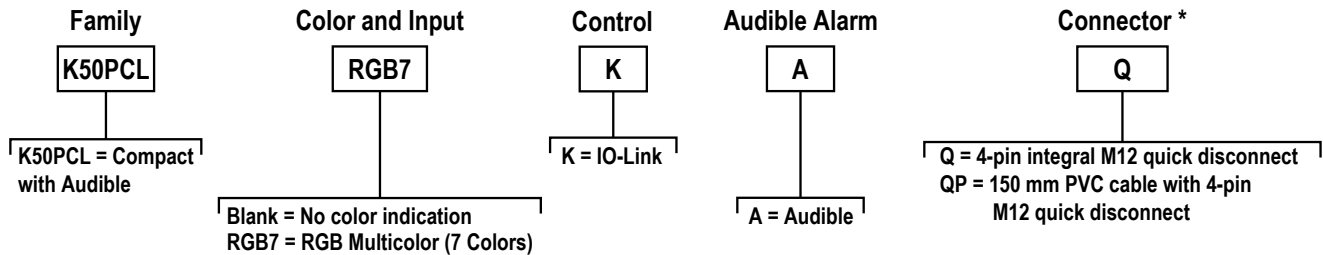

* Models with a quick disconnect require a mating cordset

Wiring Diagram

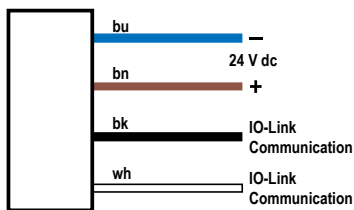

IO-Link Process Data Out (Master to Device)

Use process data out to define device states. Use parameter data to define device modes, states, custom audible settings, and custom colors.

Advanced Mode (All Models)

Use process data to control delays, color, intensity, flash, audible tones, and other animation types. Process data is also used to control the sequence value dynamically. Use parameter data to create custom colors, intensity, and speeds.

Multicolor Mode (RGB7 Models)

Use process data to activate the defined device state. Use parameter data to control delays, color, intensity, flash, and other animation types.

Multifunction Mode (Audible-Only Models)

Use process data to activate the defined device state. Use parameter data to control audible tones.



Definitions for device states in Advanced Mode and Multicolor Mode — RGB7 Models	
Name	Description
Animation Type	
Off	Indicator is off
Steady	Color 1 is solid on at defined intensity
Flash	Color 1 flashes at defined speed, color intensity, and pattern
Two Color Flash	Color 1 and Color 2 flash alternately at defined speed, color intensities, and pattern
50/50	Color 1 is displayed on 50% of the indicator and Color 2 is displayed on the other 50% of the indicator at the defined color intensities
50/50 Rotate	Color 1 is displayed on 50% of the indicator and Color 2 is displayed on the other 50% of the indicator while rotating at the defined speed, color intensities, and rotational direction
Chase	Color 1 is displayed as a single spot against the background of Color 2 while rotating at the defined speed, color intensities, and rotational direction
Intensity Sweep	Color 1 repeatedly increases and decreases intensity between 0% to 100% at defined speed and color intensity
Color Sweep	Color 1 and Color 2 transition alternately at defined speed and color intensities
Sequence	Color 1 increments against the background of Color 2 at defined Dynamic or Static Sequence Value (Advanced mode and other modes respectively)
Wave	Color 1 increments in a sweeping pattern around the perimeter of the device
Double Wave	Color 1 increments against the background of Color 2 in a sweeping pattern around the perimeter of the device
Animation Direction	Defines the direction of rotation for the 50/50 rotate, chase, sequence, and wave animations (CW or CCW)
Animation Pattern	Defines the flash pattern for flash and two color flash animations (normal, strobe, three pulse, SOS, or random)
Animation Speed	Defines the animation speed (slow, medium, fast, or custom)
Off Delay Type	Defines if the Off Delay should be measured from when the conditions for the State began (Leading Edge) or from when the conditions ended (Trailing Edge)
Off Delay (ms)	The duration of the animation Off Delay. Leading Edge Off Delays can be used to ensure the animation is active for at least a minimum amount of time.
Dynamic/Static Sequence Value	Defines the span of Color 1 in the Sequence animation [0-255]. 0 means no portion of the animation will be Color 1, and it increases in a circular manner to 255 which indicates the full circumference will be Color 1. In Advanced Mode, this is in process data and is called Dynamic Sequence Value. In the other modes, this is in parameter data and is called Static Sequence Value.
Sequence Shift	Shifts the beginning of the sequence animation to the specified LED (LED1 at 12 o'clock continuing in the direction indicated by the Animation Direction parameter)
Color 1	Defines Color 1 of defined animation
Color 1 Intensity	Defines the intensity of Color 1 in the animation (high, medium, low, off, or custom)
Color 2	Defines Color 2 of defined animation
Color 2 Intensity	Defines the intensity of Color 2 in the animation (high, medium, low, off, or custom)
Audible Feedback	Defines the type of audible feedback
Audible Volume	Defines the volume of the audible tone
Audible Type	Defines the type of audible tone played

Definitions for device states in Advanced Mode and Multifunction Mode — Audible-Only Models	
Name	Description
Audible Feedback	Defines the type of audible feedback
Audible Volume	Defines the volume of the audible tone
Audible Type	Defines the type of audible tone played

LED Control Mode (RGB7 Models)

Use process data to define the color and intensity of each individual LED. Use parameter data to define customer colors and intensities. LED1 is oriented at the 12 o'clock position continuing clockwise through LED8 near 11 o'clock position.

Name	Description
LED 1 Color...LED 8 Color	Defines the color of the designated LED.
LED 1 Intensity...LED 8 Intensity	Defines the intensity of the designated LED [Values: 0-10]
Audible Feedback	Defines the type of audible feedback

Name	Description
Audible Volume	Defines the volume of the audible tone
Audible Type	Defines the type of audible tone played

Demo Mode (RGB7 Models)

Cycles through all 14 available colors. When set to demo mode, the device will cycle through the defined sequence when power is applied regardless of its connection to an IO-Link master.

Custom Audible Settings (All Models)

Use Parameter Data to define the following settings.

Setting	Description
Custom Audible Type	Defines the type of audible tone for the custom audible tone
Sweep Type	Defines the direction of the sweep audible tone, if selected
Frequency 1	Defines a frequency that will act as the start/end frequency for sweeps, or a set frequency for tones/beeps
Frequency 2	Defines a frequency that will act as the start/end frequency for sweeps, or a set frequency for tones/beeps

Specifications

Supply Voltage and Current

18 V DC to 30 V DC

Standard Models: 145 mA maximum

- 130 mA at 18 V DC
- 83 mA at 24 V DC
- 69 mA at 30 V DC

Audible-Only Models: 25 mA maximum

- 22 mA at 18 V DC
- 14 mA at 24 V DC
- 13 mA at 30 V DC

Supply Protection Circuitry

Protected against reverse polarity and transient voltages

Leakage Current Immunity

400 μ A

Input Response Time

250 milliseconds maximum

Audible Characteristics

Values shown apply to continuous tone. Frequency and intensity response vary depending on the Audible Tone selected.

2.9 KHz \pm 250 Hz

Audible Intensity:

- Low intensity at 2.9 KHz: 83 dB at 1 m
- Medium intensity at 2.9 KHz: 88 dB at 1 m
- High intensity at 2.9 KHz: 92 dB at 1 m

Connections

Integral 4-pin M12 male quick-disconnect connector or 150 mm (6 in) PVC cable with an M12 quick disconnect, depending on model
Models with a quick disconnect require a mating cordset

Mounting

M30 by 1.5 threaded base, maximum torque 4.5 N·m (40 inch-lbf)
Mounting nut included

Vibration and Mechanical Shock

Meets IEC 60068-2-6 requirements (Vibration: 10 Hz to 55 Hz, 1.0 mm amplitude, 5 minutes sweep, 30 minutes dwell)
Meets IEC 60068-2-27 requirements (Shock: 30G 11 ms duration, half sine wave)

Operating Conditions

-40 °C to +50 °C (-40 °F to +122 °F)

90% at +50 °C maximum relative humidity (non-condensing)

Storage Temperature: -40 °C to +70 °C (-40 °F to +158 °F)

Environmental Rating

IP67, IP69K per DIN 40050-9

Meets UL Type 4X, and UL Type 12 or UL Type 13 when mounted in a UL Type 12 or Type 13 enclosure

All cabled models also meet IP69K per DIN 40050-9 if the cable and cable entrance are protected from high-pressure spray

Default Indicator Characteristics

Color	Dominant Wavelength (nm) or Color Temperature (CCT)	Color Coordinates ¹		Lumen Output (Typical at 25 °C)
		x	y	
Green	532	0.181	0.735	8.9
Red	621	0.691	0.308	3.9
Yellow	578	0.473	0.474	11.6
Blue	467	0.137	0.056	1.6
Magenta	-	0.379	0.177	5.7
Cyan	492	0.150	0.334	10.1
Amber	590	0.552	0.414	7.8
Rose	-	0.508	0.230	4.7
Lime Green	565	0.393	0.535	11.5
Orange	600	0.611	0.370	6
Sky Blue	485	0.146	0.241	10.6
Violet	-	0.212	0.091	3.4
Spring Green	509	0.157	0.553	9.3
White	5700K	0.328	0.337	13.7

¹ Refer to CIE 1931 chromaticity diagram or color chart, to show equivalent color with indicated color coordinates. Actual coordinates may differ by 10%.

Construction

Model Base, Dome, and Nut: Polycarbonate

Certifications



Banner Engineering Europe Park Lane,
Culliganlaan 2F bus 3, 1831 Diegem, BELGIUM



Turck Banner LTD Blenheim House, Blenheim
Court, Wickford, Essex SS11 8YT, Great Britain



Required Overcurrent Protection



WARNING: Electrical connections must be made by qualified personnel in accordance with local and national electrical codes and regulations.

Overcurrent protection is required to be provided by end product application per the supplied table.
Overcurrent protection may be provided with external fusing or via Current Limiting, Class 2 Power Supply.
Supply wiring leads < 24 AWG shall not be spliced.
For additional product support, go to www.bannerengineering.com.

Supply Wiring (AWG)	Required Overcurrent Protection (Amps)
20	5.0
22	3.0
24	2.0
26	1.0
28	0.8
30	0.5

Dimensions

All measurements are listed in millimeters [inches], unless noted otherwise.

150 mm PVC Cable Quick Disconnect Models

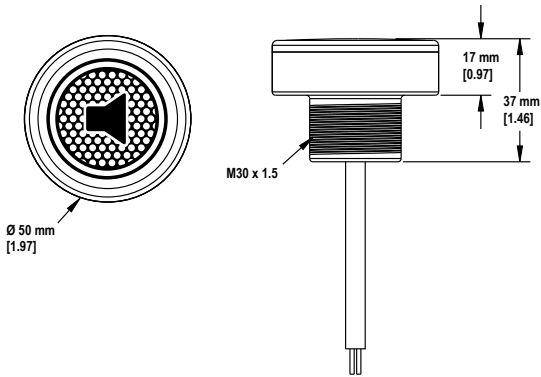

Quick Disconnect Models

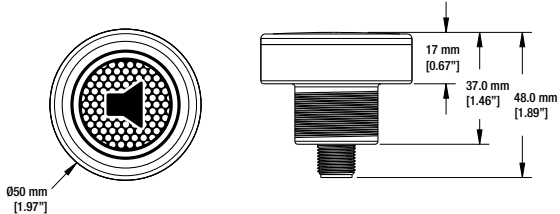

Accessories

Cordsets

4-Pin Threaded M12 Cordsets—Double Ended				
Model	Length	Style	Dimensions	Pinout
MQDEC-401SS	0.31 m (1 ft)	Male Straight/ Female Straight		Female
MQDEC-403SS	0.91 m (2.99 ft)			
MQDEC-406SS	1.83 m (6 ft)			Male
MQDEC-412SS	3.66 m (12 ft)			
MQDEC-420SS	6.10 m (20 ft)			
MQDEC-430SS	9.14 m (30.2 ft)			
MQDEC-450SS	15.2 m (49.9 ft)			
				1 = Brown 2 = White 3 = Blue 4 = Black

4-Pin Threaded M12 Cordsets—Double Ended, Oil Resistant				
Model	Length	Style	Dimensions	Pinout
MQDEC-401SS-PUR	0.3 m (0.98 ft)	Male Straight/ Female Straight		Female
MQDEC-403SS-PUR	1 m (3.28 ft)			
MQDEC-406SS-PUR	2 m (6.56 ft)			Male
MQDEC-415SS-PUR	5 m (16.4 ft)			
MQDEC-430SS-PUR	10 m (32.8 ft)			<p>1 = Brown 2 = White 3 = Blue 4 = Black</p>

4-Pin Threaded M12 Cordsets—Double Ended, Washdown, Stainless Steel				
Model	Length	Style	Dimensions	Pinout
MQDEC-WDSS-401SS	0.31 m (1 ft)	Male Straight/ Female Straight		Female
MQDEC-WDSS-403SS	0.91 m (2.99 ft)			
MQDEC-WDSS-406SS	1.83 m (6 ft)			Male
MQDEC-WDSS-412SS	3.66 m (12 ft)			
				<p>1 = Brown 2 = White 3 = Blue 4 = Black</p>

Brackets

SMB30A

- Right-angle bracket with curved slot for versatile orientation
- Clearance for M6 (1/4 in) hardware
- Mounting hole for 30 mm sensor
- 12-ga. stainless steel

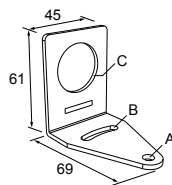

Hole center spacing: A to B=40

Hole size: A=ø 6.3, B= 27.1 x 6.3, C=ø 30.5

SMB30FVK

- V-clamp, flat bracket and fasteners for mounting to pipe or extensions
- Clamp accommodates 28 mm dia. tubing or 1 in. square extrusions
- 30 mm hole for mounting sensors

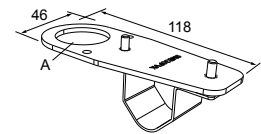

Hole size: A= ø 31

SMB30RAVK

- V-clamp, right-angle bracket and fasteners for mounting sensors to pipe or extrusion
- Clamp accommodates 28 mm dia. tubing or 1 in. square extrusions
- 30 mm hole for mounting sensors

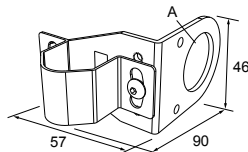

Hole size: A = ø 30.5

SMBAMS30P

- Flat SMBAMS series bracket
- 30 mm hole for mounting sensors
- Articulation slots for 90°+ rotation
- 12-ga. 300 series stainless steel

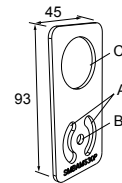

Hole center spacing: A=26.0, A to B=13.0

Hole size: A=26.8 x 7.0, B=ø 6.5, C=ø 31.0

SMBAMS30RA

- Right-angle SMBAMS series bracket
- 30 mm hole for mounting sensors
- Articulation slots for 90°+ rotation
- 12-ga. (2.6 mm) cold-rolled steel

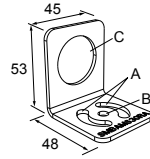

Hole center spacing: A=26.0, A to B=13.0
Hole size: A=26.8 x 7.0, B=∅ 6.5, C=∅ 31.0

SMB30MM

- 12-ga. stainless steel bracket with curved mounting slots for versatile orientation
- Clearance for M6 (¼ in) hardware
- Mounting hole for 30 mm sensor

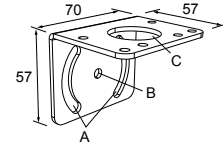

Hole center spacing: A = 51, A to B = 25.4
Hole size: A = 42.6 x 7, B = ∅ 6.4, C = ∅ 30.1

SMB30SC

- Swivel bracket with 30 mm mounting hole for sensor
- Black reinforced thermoplastic polyester
- Stainless steel mounting and swivel locking hardware included

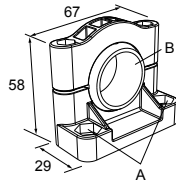

Hole center spacing: A=∅ 50.8
Hole size: A=∅ 7.0, B=∅ 30.0

SMB30FA

- Swivel bracket with tilt and pan movement for precise adjustment
- Mounting hole for 30 mm sensor
- 12-ga. 304 stainless steel
- Easy sensor mounting to extrude rail T-slot
- Metric and inch size bolt available

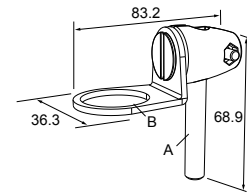

Bolt thread: SMB30FA, A= 3/8 - 16 x 2 in; SMB30FAM10, A= M10 - 1.5 x 50
Hole size: B= ∅ 30.1

LMBE12RA35

- Direct mounting of stand-off pipe, with common bracket type
- Zinc-plated steel
- 1/2-14 NPSM nut
- Mounting distance from the wall to the center of the 1/2-14 NPSM nut is 35 mm

Hole center spacing: 20.0

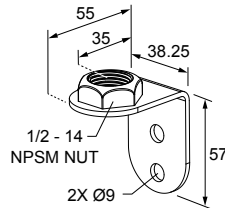
**LMBE12RA45**

- Direct mounting of stand-off pipe, with common bracket type
- Zinc-plated steel
- 1/2-14 NPSM nut
- Mounting distance from the wall to the center of the 1/2-14 NPSM nut is 45 mm

Hole center spacing: 35.0

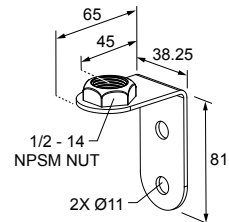

All measurements are listed in millimeters [inches], unless noted otherwise.

Banner Engineering Corp. Limited Warranty

Banner Engineering Corp. warrants its products to be free from defects in material and workmanship for one year following the date of shipment. Banner Engineering Corp. will repair or replace, free of charge, any product of its manufacture which, at the time it is returned to the factory, is found to have been defective during the warranty period. This warranty does not cover damage or liability for misuse, abuse, or the improper application or installation of the Banner product.

THIS LIMITED WARRANTY IS EXCLUSIVE AND IN LIEU OF ALL OTHER WARRANTIES WHETHER EXPRESS OR IMPLIED (INCLUDING, WITHOUT LIMITATION, ANY WARRANTY OF MERCHANTABILITY OR FITNESS FOR A PARTICULAR PURPOSE), AND WHETHER ARISING UNDER COURSE OF PERFORMANCE, COURSE OF DEALING OR TRADE USAGE.

This Warranty is exclusive and limited to repair or, at the discretion of Banner Engineering Corp., replacement. **IN NO EVENT SHALL BANNER ENGINEERING CORP. BE LIABLE TO BUYER OR ANY OTHER PERSON OR ENTITY FOR ANY EXTRA COSTS, EXPENSES, LOSSES, LOSS OF PROFITS, OR ANY INCIDENTAL, CONSEQUENTIAL OR SPECIAL DAMAGES RESULTING FROM ANY PRODUCT DEFECT OR FROM THE USE OR INABILITY TO USE THE PRODUCT, WHETHER ARISING IN CONTRACT OR WARRANTY, STATUTE, TORT, STRICT LIABILITY, NEGLIGENCE, OR OTHERWISE.**

Banner Engineering Corp. reserves the right to change, modify or improve the design of the product without assuming any obligations or liabilities relating to any product previously manufactured by Banner Engineering Corp. Any misuse, abuse, or improper application or installation of this product or use of the product for personal protection applications when the product is identified as not intended for such purposes will void the product warranty. Any modifications to this product without prior express approval by Banner Engineering Corp will void the product warranties. All specifications published in this document are subject to change; Banner reserves the right to modify product specifications or update documentation at any time. Specifications and product information in English supersede that which is provided in any other language. For the most recent version of any documentation, refer to: www.bannerengineering.com.

For patent information, see www.bannerengineering.com/patents.

FCC Part 15

This device complies with Part 15 of the FCC Rules. This equipment generates, uses, and can radiate radio frequency energy and, if not installed and used in accordance with the instruction manual, may cause harmful interference to radio communications. Operation is subject to the following two conditions: 1) This device may not cause harmful interference; and 2) This device must accept any interference received, including interference that may cause undesired operation.

Industry Canada

This device complies with CAN ICES-3 (B)/NMB-3(B). Operation is subject to the following two conditions: 1) This device may not cause harmful interference; and 2) This device must accept any interference received, including interference that may cause undesired operation.

Cet appareil est conforme à la norme NMB-3(B). Le fonctionnement est soumis aux deux conditions suivantes : (1) ce dispositif ne peut pas occasionner d'interférences, et (2) il doit tolérer toute interférence, y compris celles susceptibles de provoquer un fonctionnement non souhaité du dispositif.



more sensors, more solutions