

Area Monitoring Gateway with CLOUD ID™



Scalable Condition Monitoring Solution

The Area Monitoring Gateway with Cloud ID from Banner Engineering provides real-time insights about the operation and performance of the assets in your facility. This helps you make informed decisions to increase productivity, save energy, and prevent unexpected maintenance issues.

Benefits:

- User-friendly, no-code setup—begin monitoring equipment in minutes, not months
- Automatically recognizes an array of compatible sensors
- Measures vibration, differential pressure, temperature and humidity, tank level, and a lot more
- Almost any asset in your facility can be monitored

Applications:

- Pumps, motors, and gearboxes
- Rooftop HVAC units
- Air compressors
- Dust-collection units

Banner's Cloud Data Services platform provides access to your data in customizable online dashboards on a device of your choice. Allow your maintenance, production, and sustainability teams real-time access to data, to evaluate overall operational performance from anywhere.

Area Monitoring Gateway with CLOUD ID™

The Area Monitoring Gateway with Cloud ID enables users to obtain actionable insights about their industrial processes. It is a robust and easily deployable condition monitoring solution. From high-grade sensing hardware and gateways, to trusted network connectivity and intuitive software, the Banner Cloud ID solution provides the entire stack of technologies needed to evaluate the Industrial Internet of Things (IIoT) within an enterprise.

Cloud ID is a technology from Banner Engineering that simplifies IIoT projects by providing a no-code platform where wireless sensor nodes are automatically recognized by compatible gateways. Cloud ID also automates the cloud dashboard development process by automatically configuring dashboards based on sensor nodes connected to the gateway.



Think Big, Start Small, Scale Fast

The Area Monitoring Gateway with Cloud ID can deliver value in minutes with a simple curated setup and commissioning process. Choose from a family of industrial-grade sensor nodes that are compatible with these gateways, and adapt the system for the specific requirements of the application or facility.

Cloud ID solutions combine both hardware and software as part of a comprehensive condition monitoring strategy. With wireless and cloud technology, you can actively track machine performance online, conduct predictive maintenance, and improve operational efficiency. This approach is a prime application of IIoT (the Industrial Internet of Things). For manufacturers, Cloud ID achieves several important goals:

Enables Data-Driven Decision-Making

Cloud ID solutions are designed to begin collecting data and providing value on day one. With more information on the health and productivity of your equipment, you can make more informed decisions about maintenance, where to assign production based on availability and throughput, and more.

Provides End-to-End IIoT Solutions

Gateways in Banner Cloud ID solutions are preconfigured to easily connect with a wide variety of our compatible sensors right out of the box. Because there is no programming needed, you spend less time setting up and commissioning the system. It also means that more people across your organization can deploy Cloud ID, with less reliance on your most technical personnel.

Reduces Installation Time and Cost

Set up your entire end-to-end condition monitoring solution in a few simple steps: apply power, bind sensors to the gateway, activate the data services, then install sensors on your equipment and immediately push data to the cloud.

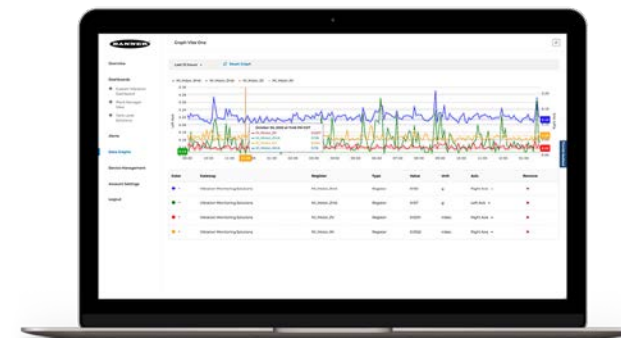

Maximizes Uptime and Increases Efficiency

Condition monitoring for predictive maintenance is a key capability of our Banner Cloud ID solution. Our Cloud Data Services (CDS) platform allows users to access, store, protect, and export critical data collected by Banner's wireless sensors. Device data is actionable, making it easy to identify trends, predict maintenance requirements, avoid costly equipment failures, and prevent unplanned downtime.

Features:

- Up to 40 sensor nodes can be connected for your specific application needs
- Preconfigured gateway provides time-saving direct-to-cloud functionality
- Wireless gateway rated for indoor and outdoor applications
- Prepaid trial for Banner Cloud Data Services platform, which delivers valuable insights and alerts
- 900 MHz or 2.4GHz ISM radio for long-range communication with wireless sensor nodes
- On-board display for wireless sensor network commissioning and configuring the solution for Ethernet or optional cellular connectivity

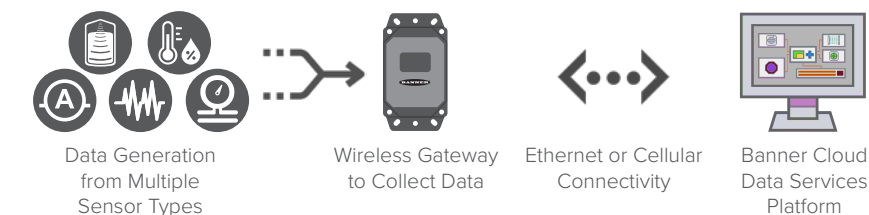

Acquire Insights with One Direct-to-Cloud Solution

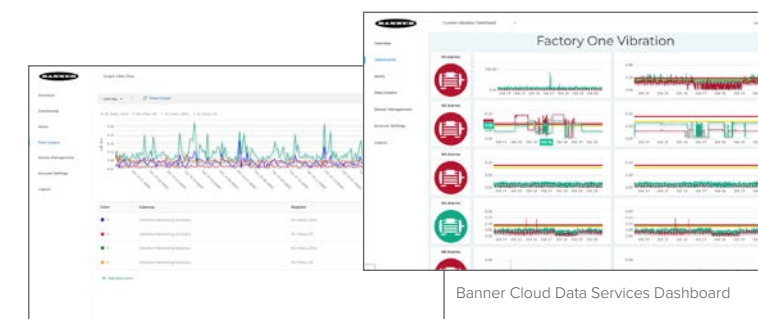

Compatible Sensor Nodes

Part of making installation easy is eliminating the need to run cables between devices on your equipment. These sensor nodes are battery powered and can monitor a variety of points such as vibration, temperature, humidity, fill level, pressure, and current.





Area Monitoring Gateway

Banner's wireless gateway is an industrial wireless device that facilitates Industrial Internet of Things (IIoT) applications. As a communications gateway, it offers seamless connectivity by hosting a robust ISM radio network for local wireless devices. These devices are used to acquire and transmit data from assets within the industrial environment. The intuitive on-board display is used to bind the nodes to the wireless network, and the device arrives preconfigured for Ethernet communication to Banner Cloud Data Services.

- Equipped with IP67-rated housing for use in challenging environments
- DC power supply included within Banner Cloud ID Gateway
- Embedded cellular device provides optional connection to Verizon, AT&T, or multiple carriers for international regions
- External antennas ensure reliable data transmission in all conditions
- Default Ethernet connection (users can also enable Cellular Data Services in minutes)



Description	Models
ISM 900 MHz radio; preconfigured device detection and Ethernet communication with Verizon cellular module and SIM	DXM1200-CK9-V
ISM 900 MHz radio; preconfigured device detection and Ethernet communication with AT&T cellular module and SIM	DXM1200-CK9-A
ISM 2.4 GHz radio; preconfigured device detection and Ethernet communication with multi-carrier cellular module and SIM	DXM1200-CK2-W

Supply Voltage	12 to 30 V DC (use only with a suitable Class 2 power supply (UL) or a Limited Power Source (LPS) (CE) power supply)
Construction	Polycarbonate
Environmental Rating	IEC IP67
Operating Conditions	-20 to +60 °C (-4 to +140 °F)
Push to Cloud Rate	Once every 5 minutes (Ethernet connection) [default] Once every 10 minutes (cellular connection)
900 MHz Compliance	FCC ID UE3RM1809; FCC Part 15, Subpart C, 15.247 IC: 7044A-RM1809 IFT: RCPBARM13-2283
Cellular Connectivity	4G LTE CATM1 (LTE-M/NB-IoT)
2.4 GHz Compliance (SX243 Radio Module)	FCC ID: UE3SX243; FCC Part 15, Subpart C, 15.247 Radio Equipment Directive (RED) 2014/53/EU IC: 7044A-SX243
900 MHz Certifications	 
2.4 GHz Certifications	

Support Literature	
216539	Sure Cross® DXM1200-Bx Wireless Controller Instruction Manual
196719	Sure Cross® DXM1200-Bx Wireless Controller Datasheet
222401	Banner Cloud ID Kit Setup Guide

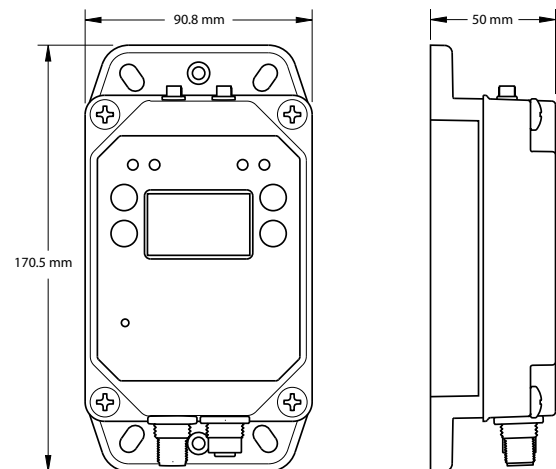

Compatible Sensors for Your Area Monitoring Gateway

Use the simple binding process to bind sensor nodes to the gateway that monitors tank level, ambient temperature and humidity, and the health of rotating machines and pressurized systems.

The radio frequency of compatible sensors must match the radio frequency of the Gateway Controller (or some other designator).



All-in-One Vibration Sensor Node

Vibration and temperature sensors that monitor the health and performance of motors, pumps, and similar equipment with rotating motion. Available accessories are shown below.

Radio Frequency	Power Supply	Inputs	Models
900 MHz ISM band	C cell lithium battery (included)	Vibration and temperature detection	DX80N9Q45VAC
2.4 GHz ISM band	C cell lithium battery (sold separately)		DX80N2Q45VAC NB

Includes mounting bracket BWA-Q45VAC-FESS.

Accessories







	Curved surface magnet mount	BWA-Q45VAC-CMSS
	Flat surface epoxy mount	BWA-Q45VAC-FESS
	3.6 V C cell lithium replacement battery	BWA-BATT-013

Wireless Node and Compact Vibration Sensor

Vibration and temperature sensors that monitor the health and performance of motors, pumps, and similar equipment. Available accessories are shown below.

Radio Frequency	Power Supply	Bracket	Models
900 MHz ISM band	D cell lithium battery	Aluminum flat surface tape mount (BWA-QM30-FTAL)	DX80N9Q45VTPD-QM30
2.4 GHz ISM band	D cell lithium battery (sold separately)		DX80N2Q45VTPD-QM30 NB

Accessories

	Right-angle, low profile	LMB30LP
	Backside magnet mount	BWA-Q45VA-FMSSB
	Curved surface magnet mount	BWA-QM30-CMAL
	Flat surface magnet mount	BWA-QM30-FMSS
	Flat surface screw mount with rapid release set screw	BWAQM30-FSALR
	3.6 V D cell lithium replacement battery	BWA-BATT-011

Compatible Sensors for Your Area Monitoring Gateway (continued)





All-in-One Temperature and Humidity Sensor Node

Temperature and humidity wireless node monitors environmental conditions in a variety of applications, such as refrigerators or chillers, warehouses, cleanrooms, incubators, storage rooms, and distribution centers. Available accessories are shown below.

Radio Frequency	Power Supply	Measurement Range	Inputs	Models
900 MHz ISM band	AA lithium cell batteries	-40 to +85 °C (-40 to +185 °F)	Temperature and relative humidity (%)	DX80N9Q45THA
2.4 GHz ISM band	AA lithium cell batteries (sold separately)	0 to 100% relative humidity		DX80N2Q45THA NB

Accessories



	Right-angle, low profile	LMB30LP
	Backside magnet mount	BWA-Q45VA-FMSSB
	2 x 3.6 V 2.4 Ah AA lithium cell replacement batteries	BWA-BATT-006

All-in-One Temperature Probe Sensor Node

Thermistor nodes measure temperature in key areas or processes like air- and liquid-handling applications. Available accessories are shown below.

Radio Frequency	Power Supply	Measurement Range	Inputs	Models
900 MHz ISM band	AA lithium cell batteries	-20 to +105 °C (-4 to +221 °F)	Temperature	DX80N9Q45TA
2.4 GHz ISM band	AA lithium cell batteries (sold separately)			DX80N2Q45TA NB

Accessories

	Right-angle, low profile	LMB30LP
	Backside magnet mount	BWA-Q45VA-FMSSB
	2 x 3.6 V 2.4 Ah AA lithium cell replacement batteries	BWA-BATT-006





All-in-One Dual Temperature Probe Sensor Node

Dual Thermistor nodes measure two temperatures in key areas of processes like air- and liquid handling applications and also report the differential between them. Available accessories are shown below.

Radio Frequency	Power Supply	Measurement Range	Inputs	Models
900 MHz ISM band	AA lithium cell batteries	-20 to +105 °C (-4 to +221 °F)	Temperature	DX80N9Q45DT
2.4 GHz ISM band	AA lithium cell batteries (sold separately)			DX80N2Q45DT NB

Accessories

	Right-angle, low profile	LMB30LP
	Backside magnet mount	BWA-Q45VA-FMSSB
	2 x 3.6 V 2.4 Ah AA lithium cell replacement batteries	BWA-BATT-006





All-in-One Ultrasonic Sensor Node

Ultrasonic sensor nodes monitor the level or position of fluid or dry assets in tanks, totes, and containers. Available accessories are shown below.

Radio Frequency	Power Supply	Ultrasonic Input Range and Frequency	Inputs	Models
900 MHz ISM band	AA lithium cell batteries	Range: 100 mm to 1 m (3.94 in to 39.4 in) Frequency: 240 kHz	One ultrasonic input and one thermistor input	DX80N9Q45UAA
2.4 GHz ISM band	AA lithium cell batteries (sold separately)			DX80N2Q45UAA NB
900 MHz ISM band	AA lithium cell batteries	Range: 300 mm to 3 m (11.8 in to 118 in) Frequency: 114 kHz		DX80N9Q45UAC
2.4 GHz ISM band	AA lithium cell batteries (sold separately)			DX80N2Q45UAC NB

Accessories

	Backside magnet mount	BWA-Q45VA-FMSSB
	2 x 3.6 V 2.4 Ah AA lithium cell replacement batteries	BWA-BATT-006





All-in-One Current Sensor Node

Wireless node uses a current transformer to measure current draw, helping to reveal issues with critical motor performance. Available accessories are shown below.

Radio Frequency	Power Supply	Measurement Range	Inputs	Models
900 MHz ISM band	AA lithium cell batteries	0–20 or 0–150 Amps	Amperage (two current transformers included)	DX80N9Q45CT
2.4 GHz ISM band	AA lithium cell batteries (sold separately)			DX80N2Q45CT NB

Accessories

	Right-angle, low profile	LMB30LP
	Backside magnet mount	BWA-Q45VA-FMSSB
	2 x 3.6 V 2.4 Ah AA lithium cell replacement batteries	BWA-BATT-006

Compatible Sensors for Your Area Monitoring Gateway (continued)

Wireless Node and Pressure Sensor

Wireless node and pressure transducers measure air, gas, and liquid pressure systems and equipment. Available accessories are shown below.



Communication	Power Supply	Pressure Range	Inputs	Models
900 MHz ISM frequency band	D cell lithium battery	0–50 PSI	Pressure	DX80N9Q45UPSD-PS50
		0–150 PSI		DX80N9Q45UPSD-PS150
		0–500 PSI		DX80N9Q45UPSD-PS500
		0–3000 PSI		DX80N9Q45UPSD-PS3000
2.4 GHz ISM frequency band	D cell lithium battery (sold separately)	0–50 PSI		DX80N2Q45UPSD-PS50 NB
		0–150 PSI		DX80N2Q45UPSD-PS150 NB
		0–500 PSI		DX80N2Q45UPSD-PS500 NB
		0–3000 PSI		DX80N2Q45UPSD-PS3000 NB

Accessories



Right-angle, low profile

LMB30LP



3.6 V D lithium cell replacement battery

BWA-BATT-011

Wireless Node and Differential Pressure Sensor

Wireless node and differential pressure sensors provide the ability to monitor low-pressure applications such as filter and vacuum lines, HVAC and duct pressure, dust collectors, clean rooms, fume hoods, and air flow. Available accessories are shown below.



Communication	Power Supply	Pressure Range	Inputs	Models
900 MHz ISM frequency band	D cell lithium battery	±1 inches of water column	Low-pressure differential sensor	DX80N9Q45DPSD-DP1
		±5 inches of water column		DX80N9Q45DPSD-DP5
		±20 inches of water column		DX80N9Q45DPSD-DP20
2.4 GHz ISM frequency band	D cell lithium battery (sold separately)	±1 inches of water column		DX80N2Q45DPSD-DP1 NB
		±5 inches of water column		DX80N2Q45DPSD-DP5 NB
		±20 inches of water column		DX80N2Q45DPSD-DP20 NB

Accessories



Right-angle, low profile

LMB30LP



3.6 V D lithium cell replacement battery

BWA-BATT-011



Banner Engineering Corp.

9714 10th Avenue North • Minneapolis, MN 55441 • 1-888-373-6767 • www.bannerengineering.com