

# HOBO® TidbiT® MX Temp 400 (MX2203) and Temp 5000 (MX2204) Logger Manual



MX2203 Model Shown

## HOBO TidbiT MX Temp Logger

### Models:

- MX Temp 400 (MX2203)
- MX Temp 5000 (MX2204)

### Items included:

- Protective boot

### Required Items:

- HOBOconnect app
- Mobile device with Bluetooth and iOS, iPadOS®, or Android™, or a Windows computer with a native BLE adapter or supported BLE dongle

### Accessories:

- Solar radiation shield (RS1 or M-RSA) for MX2203
- Mounting bracket for solar radiation shield (MX2200-RS-BRACKET), for use with MX2203 models
- Replacement O-rings (MX2203-ORING) for MX2203
- Replacement boots for both models in gray (BOOT-MX220x-GR), black (BOOT-MX220x-BK), or white (BOOT-MX220x-WH)

HOBO TidbiT MX Temp loggers measure temperature in streams, lakes, oceans, coastal habitats, and soil environments. Housed in a protective boot, these rugged loggers are designed for extended deployments in fresh or salt water at depths up to 400 ft (MX2203) or 5,000 ft (MX2204). The loggers use Bluetooth® Low Energy for wireless communication with a phone, tablet, or computer, and are equipped with an optional water detection feature that automatically turns Bluetooth advertising off when the logger is submerged in water, thereby preserving battery power. Using the HOBOconnect® app, you can easily configure the loggers, download logged data to your mobile device or computer, or automatically upload the data to HOBOLink® for further analysis. You can also configure the loggers to calculate statistics, set up alarms to trip at specific thresholds, or enable burst logging in which data is logged at a faster interval when sensor readings are above or below certain limits.

## Specifications



### Temperature Sensor

<b>Range</b>	MX2203: -20° to 70°C (-4° to 158°F) in air; -20° to 50°C (-4° to 122°F) in water MX2204: -20° to 70°C (-4° to 158°F) in air; -20° to 50°C (-4° to 122°F) in water, maximum sustained temperature in water 30°C (86°F)
<b>Accuracy</b>	±0.25°C from -20° to 0°C (±.45°F from -4° to 32°F) ±0.2°C from 0° to 70°C (±0.36°F from 32° to 158°F)
<b>Resolution</b>	0.01°C (0.018°F)
<b>Drift</b>	<0.1°C (0.18°F) per year
<b>Response Time</b>	MX2203: 17 minutes typical to 90% in air moving 1 m/s, unmounted; 7 minutes typical to 90% in stirred water, unmounted MX2204: 15 minutes typical to 90% in air moving 1 m/s, unmounted; 4 minutes typical to 90% in stirred water, unmounted

### Logger

<b>Logger Operating Range</b>	-20° to 70°C (-4° to 158°F)
<b>Buoyancy (Fresh Water)</b>	MX2203: 3.1 g (0.11 oz) negative MX2204: 7.6 g (0.27 oz) negative
<b>Waterproof</b>	MX2203: To 122 m (400 ft) MX2204: To 1,524 m (5,000 ft)
<b>Water Detection</b>	Water conductivity level of 100 µS/cm or greater necessary for reliable detection of water. Deionized water or water below 100 µS/cm may not be detected. The water conductivity circuit may not reliably detect water that has frozen around the electrodes, i.e. below 0°C (32°F).
<b>Radio Power</b>	1 mW (0 dBm)
<b>Transmission Range</b>	Approximately 30.5 m (100 ft) line-of-sight
<b>Wireless Data Standard</b>	Bluetooth Low Energy (Bluetooth Smart)
<b>Logging Rate</b>	1 second to 18 hours
<b>Time Accuracy</b>	±1 minute per month at 25°C (77°F)
<b>Battery</b>	CR2477 3V lithium, user replaceable in MX2203, non-replaceable in MX2204
<b>Battery Life</b>	3 years, typical at 25°C (77°F) with logging interval of 1 minute and Bluetooth Always Off disabled in software. 5 years, typical at 25°C (77°F) with logging interval of 1 minute and Bluetooth Always Off or Bluetooth Off Water Detect enabled in software. Faster logging intervals and statistics sampling intervals, burst logging, remaining connected with the app, excessive downloads, and paging may impact battery life. To ensure proper battery installation, see <i>Battery Information</i> for detailed instructions on replacing the battery in the MX2203 logger.
<b>Memory</b>	96,000 measurements

## Specifications (continued)

<b>Full Memory Download Time</b>	Approximately 45 seconds; may take longer the farther the device is from the logger
<b>Wetted Materials</b>	MX2203: Polypropylene case, Delrin® battery cover, EPDM O-ring, stainless steel screws, Santoprene® (TPE) boot MX2204: Epoxy case, Santoprene (TPE) boot
<b>Dimensions</b>	MX2203: 4.45 x 7.32 x 3.58 cm (1.75 x 2.88 x 1.41 inches) MX2204: 4.06 x 6.99 x 3.51 cm (1.6 x 2.75 x 1.38 inches)
<b>Weight</b>	MX2203: 36.2 g (1.28 oz) MX2204: 32.8 g (1.16 oz)
<b>Environmental Rating</b>	IP68
	The CE Marking identifies this product as complying with all relevant directives in the European Union (EU).
	See last page

## Logger Components and Operation

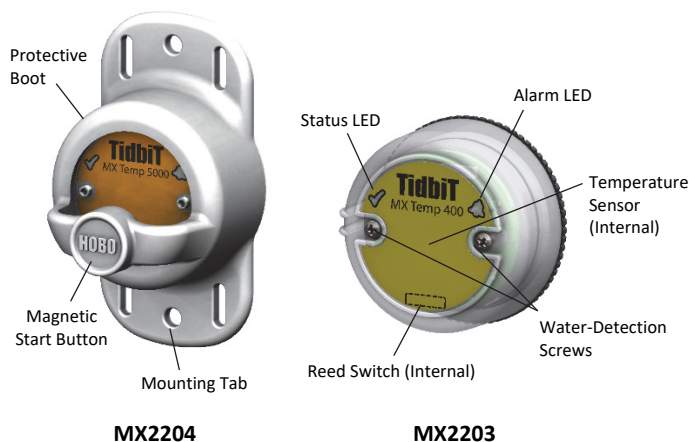

**Protective Boot:** This waterproof cover protects the logger during deployment. It has two mounting tabs and a built-in magnet to use with the logger's internal reed switch (see *Deploying and Mounting the Logger*).

**Magnetic Start Button:** This button is functional when the logger is inside the protective boot. Press this button for 3 seconds to start or stop the logger when it is configured to start or stop "On Button Push" (see *Configuring the Logger*). Press this button for 1 second to wake up the logger (if configured with Bluetooth Always Off as described in *Configuring the Logger*). You may need to press the button a second time to wake up the logger if it is logging every 5 seconds or faster and the temperature is  $-10^{\circ}\text{C}$  ( $14^{\circ}\text{F}$ ) or below.

**Mounting Tab:** Use the tabs at the top and bottom of the logger to mount it (see *Deploying and Mounting the Logger*).

**Reed Switch:** The logger has an internal reed switch represented by the dotted rectangle on the logger. The reed switch is used in conjunction with the magnetic button in the protective boot. When the logger is removed from the boot, a magnet placed over the reed switch can substitute for the built-in button (see *Deploying and Mounting the Logger*).

**Water Detection Screws:** These two screws can detect the presence of water. This allows you to configure the logger in power-saving mode in which Bluetooth advertising is active only when the logger is removed from water. See *Configuring*

*the Logger* for details. **Note:** The logger will check for the presence of water every 15 seconds when the Bluetooth Off Water Detect power-saving mode is selected.

**Temperature Sensor:** The internal temperature sensor (not visible in the diagram) is located on upper right side of the logger.

**Status LED:** This LED blinks green every 4 seconds when the logger is logging (unless Show LED is disabled as described in *Configuring the Logger*). If the logger is waiting to start logging because it was configured to start "On Button Push" or with a delayed start, it will blink green every 8 seconds. Both this LED and the Alarm LED will blink once when you press the button to wake up the logger or will blink four times when you press the

button to start or stop logging. If you select  in the app, both LEDs will be illuminated for 5 seconds (see *Getting Started* for more details).

**Alarm LED:** This LED blinks red every 4 seconds when an alarm is tripped (unless Show LED is disabled as described in *Configuring the Logger*).

## Getting Started









Install the app to connect to and work with the logger.

- Download HOBObconnect to a phone or tablet from the App Store® or Google Play™.  
Download the app to a Windows computer from [www.onsetcomp.com/products/software/hobobconnect](http://www.onsetcomp.com/products/software/hobobconnect).
- Open the app and enable Bluetooth in the device settings if prompted.
- If this is the first time you are using the logger, firmly press the magnetic start HOBOb button near the center of the logger to wake it up. The alarm and status LEDs will blink once when the logger wakes up. This will also bring the logger to the top of the list if you are working with multiple loggers.
- Tap Devices and then tap the logger in the app to connect to it.

If the logger does not appear in the list or if it is having trouble connecting, follow these tips.

- If the logger was configured with Bluetooth Always Off (see *Configuring the Logger*), it is currently logging at a fast interval (5 seconds or faster), and the temperature is -10°C (14°F) or below, you may need to press the button twice before it appears in the list.
- Make sure the logger is within range of your mobile device or computer. The range for successful wireless communication in air is approximately 30.5 m (100 ft) with full line-of-sight.
- Change the orientation of your device to ensure the antenna is pointed toward the logger. Obstacles between the antenna in the device and the logger may result in intermittent connections.
- If the logger is in water and configured with Bluetooth Off Water Detect, you must remove the logger from the water to connect to it.
- If your device can connect to the logger intermittently or loses its connection, move closer to the logger, within sight if possible. If the logger is in water, the connection can be unreliable. Remove it from water for a consistent connection.
- If the logger appears in the app, but you cannot connect to it, close the app and then power down your device to force the previous Bluetooth connection to close.

Once the logger is connected, you can:

Tap this:	To do this:
	Select logger settings and save them onto the logger to start logging. See <i>Configuring the Logger</i> .
	Read out (offload) logger data. See <i>Reading Out the Logger</i> .
	Start logging if the logger was configured to start with a button push. See <i>Configuring the Logger</i> .
	Stop the logger from recording data (this overrides any Stop Logging settings described in <i>Configuring the Logger</i> ).
	Illuminate the logger LEDs for 5 seconds.
	Set a password for the logger that will be required if another mobile device attempts to connect to it. To reset a password, press the button on the logger for 10 seconds or tap  and tap Reset.
	Mark the logger as a favorite. You can then filter the list of devices to only show loggers marked as favorites.



Update the firmware on the logger. A logger readout will be completed automatically at the beginning of the firmware update process

**Important:** Before updating the firmware on the logger, check the remaining battery level and make sure it is no less than 30%. Make sure you have the time to complete the entire update process, which requires that the logger remains connected to the device during the upgrade.



**Note:** Tapping this icon is only required when using the app on an iPhone®, iPad®, or Android device.

## Configuring the Logger

Use the app to set up the logger, including selecting the logging interval, start and stop logging options, and configuring alarms. These steps provide an overview of setting up the logger. For complete details, see the app user’s guide.

1. If the logger was previously configured with Bluetooth Always Off, press the button on the logger to wake it up. If the logger was previously configured with Bluetooth Off Water Detect and it is deployed in water, remove it from water. If you are working with multiple loggers, pressing the button also brings the logger to the top of the list in the app.
2. Tap Devices. Tap the logger in the app to connect to it.
3. Tap  to configure the logger.
4. Tap Name and type a name for the logger (optional). If no name is selected, the logger serial number is used as the name.
5. Tap Group to add the logger to a group (optional). Tap Save.
6. Tap Logging Interval and choose how frequently the logger will record data unless operating in burst logging mode (see *Burst Logging*).
7. Tap Start Logging and select when logging will begin:
  - **Now.** Logging will begin immediately after configuration settings are loaded on the logger.
  - **On Next Logging Interval.** Logging will begin at the next even interval as determined by the selected logging interval.
  - **On Button Push.** Logging will begin once you press the button on the logger for 3 seconds.
  - **On Date/Time.** Logging will begin at a date and time you specify. Select the Date and time.
 Tap Save.
8. Tap Stop Logging and select the options for when logging will end.
  - a. Choose one of two memory options:
    - **When Memory Fills.** The logger will continue recording data until the memory is full.
    - **Never (Wrap When Full).** The logger will continue recording data indefinitely, with newest data overwriting the oldest.



- b. Select On Button Push if you want to be able to stop logging by pushing the button on the logger for 3 seconds.
- c. Select one of the following time options for when to stop logging:
  - **Never.** Select this if you do not want the logger to stop at any predetermined time frame.
  - **On Date/Time.** Select this if you want the logger to stop logging on a specific date and time. Select the date and time.
  - **After.** Select this if you want to control how long the logger should continue logging once it starts. Choose the amount of time you want the logger to log data. For example, select 30 days if you want the logger to log data for 30 days after logging begins.
- d. Tap Save.
9. Tap Logging Mode. Select either fixed or burst logging. With fixed logging, the logger records data for all enabled sensors and/or selected statistics at the logging interval selected (see *Statistics Logging* for details on choosing statistics options). In burst mode, logging occurs at a different interval when a specified condition is met. See *Burst Logging* for more information. Tap Save.
10. Enable or disable Show LED. If Show LED is disabled, the alarm and status LEDs on the logger will not be illuminated while logging (the alarm LED will not blink if an alarm trips). You can temporarily turn on LEDs when Show LED is disabled by pressing the button on the logger for 1 second.
11. Select the power saving mode, which determines when the logger will “advertise” or regularly send out a Bluetooth signal for the phone, tablet, or computer to find via the app.
  - **Bluetooth Always Off.** The logger will only advertise during logging when you press the button on the protective boot (or place a magnet where the reed switch is located if the logger is out of the protective boot). This will wake up the logger when you need to connect to it. This option uses the least battery power.
  - **Bluetooth Off Water Detect.** The logger will not advertise when the presence of water is detected. Once the logger is removed from the water, advertising will automatically turn on, thereby not requiring you to push a button (or use a magnet) to wake up the logger when you need to connect to it. This option preserves some battery power. **Note:** The logger will check for the presence of water every 15 seconds when this option is selected.
  - **Bluetooth Always On.** The logger will always advertise. You will never need to push a button (or use a magnet) to wake up the logger. This option uses the most battery power.
12. You can set up alarms to trip when a sensor reading rises above or falls below a specified value. See *Setting up Alarms* for details on enabling sensor alarms.
13. Tap  to save the configuration settings.

Logging will begin based on the settings you selected. See *Deploying and Mounting the Logger* for details on mounting and see *Reading Out the Logger* for details on downloading.

## Setting up Alarms

You can set up alarms for the logger so that if a sensor reading rises above or falls below a specified value, the logger alarm LED will blink and an alarm icon will appear in the app. This can alert you to problems so you can take corrective action.

To set an alarm:

1. Tap Devices. If the logger was configured with Bluetooth Always Off enabled, press the HOBOS button on the logger to wake it up. If the logger was configured with Bluetooth Off Water Detect and is currently underwater, remove it from the water.
2. Tap the logger to connect to it and tap .
3. Tap a sensor (tap the Enable Logging toggle if necessary).
4. Select High if you want an alarm to trip when the sensor reading rises above the high alarm value. Drag the slider or type a value to set the high alarm value.
5. Select Low if you want an alarm to trip when the sensor reading falls below the low alarm value. Drag the slider or type a value to set the low alarm value.
6. For the Duration, select how much time should elapse before the alarm trips and select one of the following:
  - **Cumulative.** The alarm will trip once the sensor reading is out of the acceptable range for the selected duration any time during logging. For example, if the high alarm is set to 85°F and the duration is set to 30 minutes, then the alarm will trip once the sensor readings have been above 85°F for a total of 30 minutes since the logger was configured.
  - **Consecutive.** The alarm will trip once the sensor reading is out of the acceptable range continuously for the selected duration. For example, the high alarm is set to 85°F and the duration is set to 30 minutes, then the alarm will only trip if all sensor readings are 85°F or above for a continuous 30-minute period.
7. Tap Save.
8. In the configuration settings, select one of the following options to determine how the alarm indications are cleared:
  - **Logger Reconfigured.** The alarm indication will display until the next time the logger is reconfigured.
  - **Sensor in Limits.** The alarm indication will display until the sensor reading returns to the normal range between any configured high and low alarm limits.
9. Tap .

When an alarm trips, the logger alarm LED blinks every 4 seconds (unless Show LED is disabled), an alarm icon appears in the app, and an Alarm Tripped event is logged. The alarm state will clear when the readings return to normal if you selected Sensor in Limits in step 8. Otherwise, the alarm state will remain in place until the logger is reconfigured.

### Notes:



- Alarm limits are checked at every logging interval. For example, if the logging interval is set to 5 minutes, then the logger will check the sensor readings against your configured high and low alarm setting every 5 minutes.

- The actual values for the high and low alarm limits are set to the closest value supported by the logger. For example, the closest value to 85°F that the logger can record is 84.990°F. In addition, alarms can trip or clear when the sensor reading is within resolution specifications.
- When you read out the logger, alarm events can be displayed on the plot or in the data file. See *Logger Events*.

## Burst Logging

Burst logging is a logging mode that allows you to set up more frequent logging when a specified condition is met. For example, a logger is recording data at a 5-minute logging interval and burst logging is configured to log every 30 seconds when the temperature rises above 85°F (the high limit) or falls below 32°F (the low limit). This means the logger will record data every 5 minutes as long as the temperature remains between 85°F and 32°F. Once the temperature rises above 85°F, the logger will switch to the faster logging rate and record data every 30 seconds until the temperature falls back to 85°F. At that time, logging then resumes every 5 minutes at the normal logging interval. Similarly, if the temperature falls below 32°F, then the logger would switch to burst logging mode again and record data every 30 seconds. Once the temperature rises back to 32°F, the logger will then return to normal mode, logging every 5 minutes. **Note:** Sensor alarms, statistics, and the Stop Logging option “Wrap When Full” are not available in burst logging mode.

To set up burst logging:

1. Tap Devices. If the logger was configured with Bluetooth Always Off enabled, press the HOBOS button on the logger to wake it up. If the logger was configured with Bluetooth Off Water Detect and is currently underwater, remove it from the water.
2. Tap the logger to connect to it and tap .
3. Tap Logging Mode and then tap Burst Logging.
4. Select Low and/or High and either type or drag the slider to set the low and/or high values.
5. Set the burst logging interval, which must be faster than the logging interval. Keep in mind that the faster the burst logging rate, the greater the impact on battery life and the shorter the logging duration. Because measurements are being taken at the burst logging interval throughout the deployment, the battery usage is similar to what it would be if you had selected this rate for the normal logging interval.
6. Tap Save.
7. Tap .

### Notes:

- The high and low burst limits are checked at the burst logging interval rate whether the logger is in normal or burst condition. For example, if the logging interval is set to 1 hour and the burst logging interval is set to 10 minutes, the logger will always check for burst limits every 10 minutes.
- The actual values for the burst logging limits are set to the closest value supported by the logger. In addition,

burst logging can begin or end when the sensor reading is within the specified resolution. This means the value that triggers burst logging may differ slightly than the value entered.

- Once the high or low condition clears, the logging interval time will be calculated using the last recorded data point in burst logging mode, not the last data point recorded at the normal logging rate. For example, the logger has a 10-minute logging interval and logged a data point at 9:05. Then, the high limit was surpassed and burst logging began at 9:06. Burst logging then continued until 9:12 when the sensor reading fell back below the high limit. Now back in normal mode, the next logging interval will be 10 minutes from the last burst logging point, or 9:22 in this case. If burst logging had not occurred, the next data point would have been at 9:15.
- A New Interval event is created each time the logger enters or exits burst logging mode. See *Logger Events* for details on plotting and viewing the event. In addition, if the logger is stopped with a button push while in burst logging mode, then a New Interval event is automatically logged and the burst condition is cleared, even if the actual high or low condition has not cleared.

## Statistics Logging

During fixed interval logging, the logger records data for the temperature sensor and/or selected statistics at the logging interval selected. Statistics are calculated at a sampling rate you specify with the results for the sampling period recorded at each logging interval. The following statistics can be logged:

- The maximum, or highest, sampled value,
- The minimum, or lowest, sampled value,
- An average of all sampled values, and
- The standard deviation from the average for all sampled values.

For example, the logging interval is 5 minutes. The logging mode is set to fixed interval logging with Normal and all four statistics enabled, and with a statistics sampling interval of 30 seconds. Once logging begins, the logger will measure and record the actual temperature values every 5 minutes. In addition, the logger will take a temperature sample every 30 seconds and temporarily store them in memory. The logger will then calculate the maximum, minimum, average, and standard deviation using the samples gathered over the previous 5-minute period and log the resulting values. When reading out the logger, this would result in five data series: one temperature series (with data logged every 5 minutes) plus four maximum, minimum, average, and standard deviation series (with values calculated and logged every 5 minutes based on the 30-second sampling).

To log statistics:



1. Tap Devices. If the logger was configured with Bluetooth Always Off enabled, press the HOBOS button on the logger to wake it up. If the logger was configured with Bluetooth Off Water Detect and is currently underwater, remove it from the water.
2. Tap the logger in the app to connect to it and tap .
3. Tap Logging Mode and then select Fixed Logging.



4. Select Normal to record the current reading for the temperature sensor at the logging interval shown at the top of the screen. Do not select this if you only want to log statistics.
5. Select the statistics you want the logger to record at each logging interval: Maximum, Minimum, Average, and Standard Deviation (average is automatically enabled when selecting Standard Deviation). Statistics will be logged for all enabled sensors. In addition, the more statistics you record, the shorter the logger duration and the more memory is required.
6. Tap Statistics Sampling Interval and select the rate to use for calculating statistics. The rate must be less than, and a factor of, the logging interval. For example, if the logging interval is 1 minute and you select 5 seconds for the sampling rate, then the logger will take 12 sample readings between each logging interval (one sample every 5 seconds for a minute) and use the 12 samples to record the resulting statistics at each 1-minute logging interval. Note that the faster the sampling rate, the greater the impact on battery life. Because measurements are being taken at the statistics sampling interval throughout the deployment, the battery usage is similar to what it would be if you had selected this rate for the normal logging interval.
7. Tap Save.
8. Tap .

### Setting a Password

You can create an encrypted password for the logger that will be required if another device attempts to connect to it. This is recommended to ensure that a deployed logger is not mistakenly stopped or purposely altered by others. This password uses a proprietary encryption algorithm that changes with every connection.



To set a password:

1. Tap Devices. If the logger was configured with Bluetooth Always Off enabled, press the HOBOS button on the logger to wake it up. If the logger was configured with Bluetooth Off Water Detect and is currently underwater, remove it from the water.
2. Tap the logger in the app to connect to it. Tap  (if applicable) and then .
3. Type a password and then tap Set.

Only the device used to set the password can then connect to the logger without entering a password; all other devices will be required to enter the password. For example, if you set the password for the logger with your tablet and then try to connect to the logger later with your phone, you will be required to enter the password on the phone but not with your tablet. Similarly, if others attempt to connect to the logger with different devices, then they would also be required to enter the password. To reset a password, press the button on the logger for 10 seconds or connect to the logger and tap  (if applicable), then , and tap Reset.

### Reading Out the Logger

To download data from the logger:



1. Tap Devices.
2. If the logger was configured with Bluetooth Always On, continue to step 3.  
If the logger was configured with Bluetooth Always Off, press the button on the logger for 1 second to wake it up.  
If the logger was configured with Bluetooth Water Detect and it is deployed in water, remove it from the water.
3. Tap the logger in the app to connect to it and tap . The logger will read out the data to the phone, tablet, or computer.
4. Once the readout is complete, tap HOBO Files and select the file to view it. Tap  (if applicable) and  to export the data.

Data can also be uploaded automatically to HOBOLink, Onset's web-based software, via the app or the MX gateway. For details, see the app user's guide and see the HOBOLink help for details on working with data in HOBOLink.

### Logger Events

The logger records the following events to track logger operation and status. You can view events in exported files or plot events in the app.

To plot events, tap HOBO Files and select a file to open.

Tap  (if applicable) and then tap . Select the events you want to plot and tap OK.

Event Name	Definition
Host Connect	The logger was connected to a mobile device.
Started	The logger started logging.
Stopped	The logger stopped logging.
Alarm Tripped/Cleared	An alarm has occurred because the reading was outside the alarm limits or back within range. <b>Note:</b> Although the reading may return to a normal range, an alarm cleared event will not be logged if the logger was set up to maintain alarms until reconfigured.
Button Up/Down	The button on the logger was pressed to wake it up/bring it to the top of the loggers list in the app.
New Interval	The logger has switched to logging at the burst logging rate or back to the normal rate.
Water Detect	The logger has been placed in water or removed from water.
Power Warn	The battery level dropped below 2.3 V.
Safe Shutdown	The battery level dropped below a safe operating voltage and performed a safe shutdown.

## Deploying and Mounting the Logger

Follow these guidelines for deploying and mounting the logger.

- You can deploy the logger by using the two mounting tabs on the protective boot. Insert two screws through the holes on the mounting tabs to affix the logger to a flat surface. Insert cable ties through the rectangular holes on both mounting tabs to attach the logger to a pipe or pole.



Use cable ties with the slots; slot dimensions are 0.28 cm (0.11 in.) wide x 0.86 cm (0.34 in.) long

- Use nylon cord or other strong cable with any of the holes on the mounting tabs. If wire is used to secure the logger, make sure the wire loop is snug to the holes. Any slack in the loop may cause excessive wear.
- When deploying in water, the logger should be appropriately weighted, secured, and protected depending on water conditions and desired measurement location.
- If the TidbiT MX Temp 500 (MX2203) logger will be exposed to sunlight in the deployment location, attach it to a solar radiation shield (RS1 or M-RSA) using the solar radiation shield bracket (MX2200-RS-BRACKET). Attach the logger to the underside of the mounting plate as shown. For more details on the solar radiation shield, refer to the *Solar Radiation Shield Installation Guide* at [www.onsetcomp.com/manuals/rs1](http://www.onsetcomp.com/manuals/rs1).

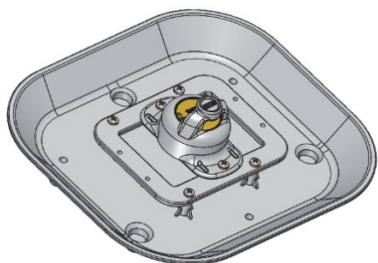

- Be careful of solvents. Check a materials compatibility chart against the wetted materials listed in the Specifications table before deploying the logger in locations where untested solvents are present. The TidbiT MX Temp 500 (MX2203) logger has an EPDM O-ring, which is sensitive to polar solvents (acetone, ketone), and oils.
- The protective boot is designed with a magnetic button that will interact with the reed switch located inside the logger. This means you do not need to remove the boot to start, stop, or wake up the logger (if On Button Push or Bluetooth Always Off configuration settings have been selected). If you remove the logger from the boot or if

the magnetic button in the boot is not working properly, you must place a magnet on the logger where the reed switch is located if you want to start or stop the logger with a button push or wake the logger up. Leave the magnet in place for 3 seconds to start or stop it or 1 second to wake it up.

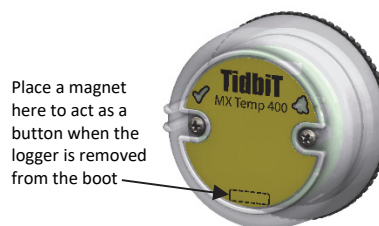

## Maintaining the Logger

- To clean the logger, remove the logger from the boot. Rinse both the logger and the boot in warm water. Use a mild dishwashing detergent if necessary. Do not use harsh chemicals, solvents, or abrasives.
- Periodically inspect the logger for biofouling if it is deployed in water and clean as described above.
- Periodically inspect the O-ring on the inside of the battery cover in the TidbiT MX Temp 400 (MX2203) logger for cracks or tears and replace it if any are detected (MX2203-ORING). See *Battery Information* for steps on replacing the O-ring.
- Periodically inspect the boot for any cracks or tears and replace it if necessary (BOOT-MX220x-XX).

## Protecting the Logger

**Note: Static electricity may cause the logger to stop logging.**

The logger has been tested to 8 KV, but avoid electrostatic discharge by grounding yourself to protect the logger. For more information, search for “static discharge” on [www.onsetcomp.com](http://www.onsetcomp.com).

## Battery Information

The logger requires one CR2477 3V lithium battery (HRB-2477), which is user-replaceable for the TidbiT MX Temp 400 (MX2203) and non-replaceable for the TidbiT MX Temp 5000 (MX2204). Battery life is 3 years, typical at 25°C (77°F) with a logging interval of 1 minute and Bluetooth Always On selected or 5 years, typical at 25°C (77°F) when the logger is configured with Bluetooth Always Off or Bluetooth Off Water Detect selected. Expected battery life varies based on the ambient temperature where the logger is deployed, the logging interval, the frequency of connections, downloads, and paging, and the use of burst mode or statistics logging. Deployments in extremely cold or hot temperatures or a logging interval faster than 1 minute can impact battery life. Estimates are not guaranteed due to uncertainties in initial battery conditions and operating environment.

To replace the battery in the TidbiT MX Temp 400 (MX2203) logger:

- Remove the logger from the boot.
- While pushing down on the back of the logger, rotate the cover counterclockwise. If your cover has lock icons, rotate it so that the icon moves from the locked to unlocked

position. The unlocked icon will then line up with the double-ridge on the side of the logger case (pointed out in step 3).

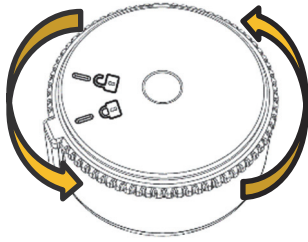

3. Use the small tab on the cover to lift it off the logger.

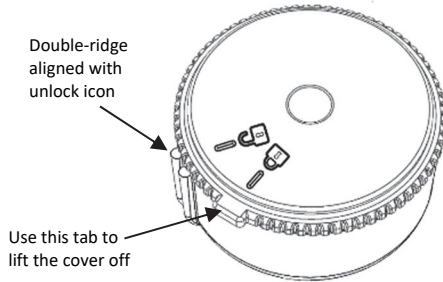

4. Remove the battery and place a new one in the battery holder, positive side facing up.
5. Inspect the O-ring on the battery cover. Make sure it is clean and seated properly. Remove any dirt, lint, hair, or debris from the O-ring. If the O-ring has any cracks or tears, replace it as follows:
  - a. Spread a small dot of silicone-based grease on the O-ring with your fingers, making sure the entire O-ring surface is completely covered in grease.
  - b. Place the O-ring on the cover and clean off any debris. Make sure the O-ring is fully seated and level in the groove and not pinched or twisted. This is necessary to maintain a waterproof seal.
6. Place the cover back on the logger, lining up the unlock icon (if applicable) with the double-ridge on the side of the logger case (shown in step 3). Make sure the cover is level as it is placed on the logger case to ensure the battery terminal maintains its proper position.

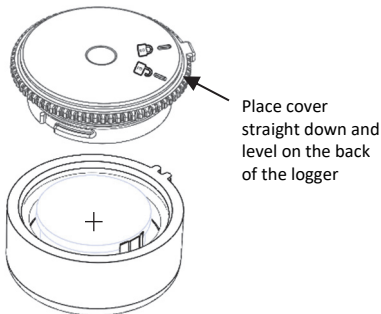

Battery Cover Placement Top View

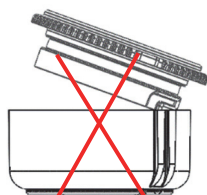

Battery Cover Side View, Incorrect Assembly

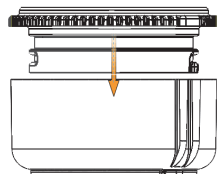

Battery Cover Side View, Correct Assembly

7. While pushing down on the cover, rotate it clockwise until the tab is aligned with the double-ridge in the logger case. If your cover has lock icons, then rotate it so that the icon moves from the unlocked to locked position. When the cover is properly positioned, the tab and the locked icon (if applicable) will be aligned with the double-ridge in the logger as shown.

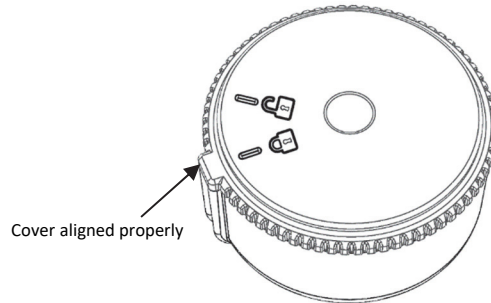

8. Place the logger back in the protective boot, making sure the double-ridge in the logger case slides into the groove on the inside of the boot.

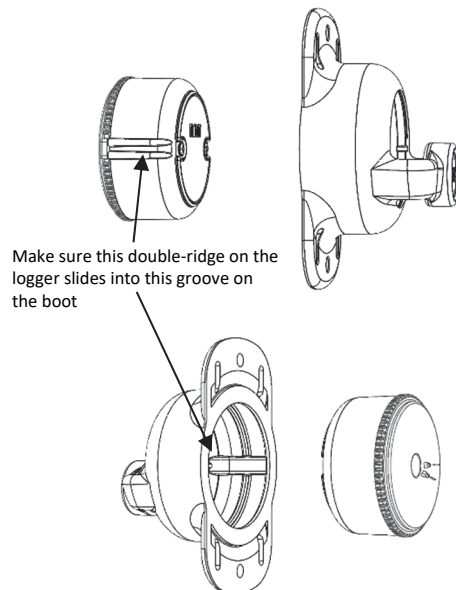

**Note:** MX2203 logger is shown in the example; the groove in the boot on an MX2204 logger is in a slightly different location.

**⚠ WARNING:** Do not cut open, incinerate, heat above 85°C (185°F), or recharge the lithium battery. The battery may explode if the logger is exposed to extreme heat or conditions that could damage or destroy the battery case. Do not dispose of the logger or battery in fire. Do not expose the contents of the battery to water. Dispose of the battery according to local regulations for lithium batteries.



---

**Federal Communication Commission Interference Statement**

This equipment has been tested and found to comply with the limits for a Class B digital device, pursuant to Part 15 of the FCC Rules. These limits are designed to provide reasonable protection against harmful interference in a residential installation. This equipment generates uses and can radiate radio frequency energy and, if not installed and used in accordance with the instructions, may cause harmful interference to radio communications. However, there is no guarantee that interference will not occur in a particular installation. If this equipment does cause harmful interference to radio or television reception, which can be determined by turning the equipment off and on, the user is encouraged to try to correct the interference by one of the following measures:

- Reorient or relocate the receiving antenna
- Increase the separation between the equipment and receiver
- Connect the equipment into an outlet on a circuit different from that to which the receiver is connected
- Consult the dealer or an experienced radio/TV technician for help

This device complies with Part 15 of the FCC Rules. Operation is subject to the following two conditions: (1) This device may not cause harmful interference, and (2) this device must accept any interference received, including interference that may cause undesired operation.

**FCC Caution:** Any changes or modifications not expressly approved by the party responsible for compliance could void the user's authority to operate this equipment.

**Industry Canada Statements**

This device complies with Industry Canada license-exempt RSS standard(s). Operation is subject to the following two conditions: (1) this device may not cause interference, and (2) this device must accept any interference, including interference that may cause undesired operation of the device.

**Avis de conformité pour l'Industrie Canada**

Le présent appareil est conforme aux CNR d'Industrie Canada applicables aux appareils radio exempts de licence. L'exploitation est autorisée aux deux conditions suivantes : (1) l'appareil ne doit pas produire de brouillage, et (2) l'appareil doit accepter tout brouillage radioélectrique subi, même si le brouillage est susceptible d'en compromettre le fonctionnement.

To comply with FCC and Industry Canada RF radiation exposure limits for general population, the logger must be installed to provide a separation distance of at least 20cm from all persons and must not be co-located or operating in conjunction with any other antenna or transmitter.

**KC Statement**

해당 무선설비는 전파혼신 가능성이 있으므로 인명안전과 관련된 서비스는 할 수 없음

**Translation:**

The service related to human safety is not allowed because this device may have the possibility of the radio interference.

