



20DAWE_1.5 series

20W - Single/Dual Output - Wide Input - Isolated & Regulated DC-DC Converter

DC-DC Converter 20 Watt

- + Efficiency up to 90%
- + 2:1 wide input voltage range
- + Output over current, over voltage protection
- + Short circuit protection (SCP)
- + 1.5kVDC isolation
- + No-load power consumption as low as 0.15W
- + Operating temperature range: -40°C ~ +85°C
- + Six-sided metal shield
- + Industry standard pinout
- + Meet CISPR32/EN55032 CLASS A, without extra components
- + EN60950 approved

The 20DAWE_1.5 series are isolated 20W DC-DC products with a 2:1 input voltage range. They feature efficiencies of up to 90%, 1500VDC input to output isolation, operating ambient temperature range of -40°C ~ +85°C, output short-circuit, over-voltage and over-current protection. They meet CLASS A of CISPR32/EN55032 EMI standards without external components.

They are widely used in applications such as data transmission device, battery power supplies, tele-communication device, distributed power supply system, hybrid module system, remote control system, industrial robot system fields.



Common specifications	
Short circuit protection:	Hiccup, continous, self-recovery
Cooling:	Free air convection
Vibrating:	10-150GHz, 5G, 90 Min. along X, Y and Z
Operation temperature range:	-40°C~+85°C
Storage temperature range:	-55°C~+125°C
Pin soldering resistance temperature:	300°C MAX, 1.5mm from case for 10 sec
Case temperature:	105°C MAX, refer to temperature derating curve (20DAWE_12110S1.5)
Storage humidity range:	5-95%RH
Switching frequency (PWM mode):	20DAWE_12110S1.5: 300KHz TYP Others: 270kHz TYP
Case material:	Aluminium alloy
MTBF (MIL-HDBK-217F@25°C):	1000 K hours MIN
Weight:	26g
Dimensions:	50.80 × 25.40 × 11.80 mm

Output specifications						
Item	Test condition	Min	Typ	Max	Units	
Output voltage accuracy ⁽¹⁾	5%-100% load <u>20DAWE_1215D1.5</u>		±1	±3	%	
	0%-100% load <u>20DAWE_1224D1.5</u>		±1	±3	%	
	• positive output • negative output <u>Others</u>		±2 ±1	±4 ±3	%	
Line regulation ⁽²⁾ (Full load, input voltage low to high)	• positive output		±0.2	±0.5	%	
	• negative output		0.5	±1	%	
Load regulation (5% to 100% load)	<u>20DAWE_1215D1.5/</u> <u>20DAWE_1224D1.5</u>		±0.5	±1	%	
	• positive output		±1	±1.5	%	
	• negative output <u>Others</u>		±0.5 ±0.5	±1 ±1.5	%	
Cross regulation	Dual output with positive output at 50% load, negative output from 10%-100% load			±5	%	
Transient recovery time	25% load step change		300	500	µs	
Transient response deviation	25% load step change • 3.3/5/±5VDC output • others		±5	±8	%	
			±3	±5	%	
Temperature drift	100% full load			±0.03	%/°C	
Ripple & Noise ⁽³⁾	20MHz Bandwidth		50	100	mVp-p	
Trim	Input voltage range (24V/48V input series)		±10		%Vo	
Over voltage protection	Input voltage range (all models; except 20DAWE_12110S1.5)	110		160	%Vo	
Over current protection	Input voltage range • 20DAWE_12110S1.5 • Others		110	130	%Io	
				190	%Io	

- ⁽¹⁾ Output voltage accuracy of ±5VDC/±9VDC output converter for 0%-5% load is ±5% max;
- ⁽²⁾ Load regulation for 0%-100% load is ±5%;
- ⁽³⁾ The "parallel cable" method is used for Ripple and Noise test. Ripple & noise at 5% load is 5%Vo. Max.

Example:
20DAWE_2415S1.5
 20 = 20Watt; D = DIP; A = series; W = wide input (2:1) 18-36Vin;
 E = cost effective; 15Vout; S = single output; 1.5 = 1500VDC isolation

Input specifications					
Item	Test condition	Min	Typ	Max	Units
Reflected ripple current	12VDC input • 110V output • others		20		mA
			30		mA
	24/48VDC input		30		mA
Surge voltage (1 sec. max)	• 12VDC input	-0.7		25	VDC
	• 24VDC input	-0.7		50	VDC
	• 48VDC input	-0.7		100	VDC
Start-up voltage	• 12VDC input			9	VDC
	• 24VDC input			18	VDC
	• 48VDC input			36	VDC
Start-up time	Nominal input & constant resistance load		10		ms
Input filter	Pi				
Ctrl ⁽¹⁾	• Module on	Ctrl pin open or pulled high (3.5-12VDC)			
	• Module off	Ctrl pin pulled low to GND (0-1.2VDC)			
	• Input current when off				
	20DAWE_12110S1.5		5		mA
	Others		4	7	mA
Hot plug	Unavailable				

⁽¹⁾ The Ctrl pin voltage is referenced to input GND.

20DAWE_1.5 series

20W - Single/Dual Output - Wide Input - Isolated & Regulated DC-DC Converter

Isolation specifications					
Item	Test condition	Min	Typ	Max	Units
Isolation voltage	Tested for 1 minute and leakage current less than 1 mA	1500			VDC
Isolation resistance	Test at 500VDC	1000			MΩ
Isolation capacitance	100KHz/0.1V • 20DAWE_2424S1.5 • 20DAWE_12110S1.5 • Others		2050 2000 1050		pF pF pF

EMC specifications					
EMI	CE	CISPR32/EN550232		CLASS A (without external components) CLASS B (see EMC compliance circuit ①)	
EMI	RE	CISPR32/EN55032 (except 20DAWE_12110S1.5)		CLASS A (without external components) CLASS B (see EMC compliance circuit ①)	
EMS	ESD	IEC/EN61000-4-2	Contact ±4KV	perf. Criteria B	
EMS	RS	IEC/EN61000-4-3	10V/m	perf. Criteria A	
EMS	EFT	IEC/EN61000-4-4	±2KV (see EMC compliance circuit ②)	perf. Criteria B	
EMS	Surge	IEC/EN61000-4-5	line to line ±2KV (see EMC compliance circuit ②)	perf. Criteria B	
EMS	CS	IEC/EN61000-4-6	3 Vr.m.s	perf. Criteria A	
EMS	Voltage dips, short and interruptions immunity	IEC/EN61000-4-29	0%-70%	perf. Criteria B	

Part Number	Input Voltage [VDC]			Output Voltage [VDC]	Output Current [mA, Max]	Input Current [mA, typ/max]		Efficiency ⁽²⁾ [%, Typ.]	Capacitive load ⁽³⁾ [μF, Max]
	Nominal	Range	Max ⁽¹⁾			Full load	No load		
20DAWE_12110S1.5	12	9-18	20	110	182	1894/1938	15/-	88	66
20DAWE_2403S1.5	24	18-36	40	3.3	5000	799/818	40/45	86	10000
20DAWE_2405S1.5	24	18-36	40	5	4000	969/993	40/45	90	10000
20DAWE_2409S1.5	24	18-36	40	9	2222	947/969	6/10	87	4700
20DAWE_2412S1.5	24	18-36	40	12	1667	947/969	6/10	87	1600
20DAWE_2415S1.5	24	18-36	40	15	1333	947/969	6/10	88	1000
20DAWE_2424S1.5	24	18-36	40	24	834	947/969	6/10	88	500
20DAWE_4803S1.5	48	36-75	80	3.3	5000	400/409	20/25	86	10000
20DAWE_4805S1.5	48	36-75	80	5	4000	485/497	20/25	90	10000
20DAWE_4809S1.5	48	36-75	80	9	2222	474/785	5/9	89	4700
20DAWE_4812S1.5	48	36-75	80	12	1667	474/785	5/9	89	1600
20DAWE_4815S1.5	48	36-75	80	15	1333	474/785	5/9	90	1000
20DAWE_4824S1.5	48	36-75	80	24	834	474/785	5/9	90	500
20DAWE_1215D1.5	12	9-18	20	±15	±667	1916/1960	12/20	87	625
20DAWE_1224D1.5	12	9-18	20	±24	±417	1894/1938	15/25	88	220
20DAWE_2405D1.5	24	18-36	40	±5	±2000	969/993	40/45	84	4800
20DAWE_2409D1.5	24	18-36	40	±9	±1111	947/969	6/10	86	1000
20DAWE_2412D1.5	24	18-36	40	±12	±834	947/969	6/10	86	800
20DAWE_2415D1.5	24	18-36	40	±15	±667	947/969	6/10	86	625
20DAWE_2424D1.5	24	18-36	40	±24	±417	947/969	6/10	86	500
20DAWE_4805D1.5	48	36-75	80	±5	±2000	485/497	20/25	86	4800
20DAWE_4812D1.5	48	36-75	80	±12	±834	474/785	5/9	88	800
20DAWE_4815D1.5	48	36-75	80	±15	±667	474/785	5/9	89	625

① Exceeding the maximum input voltage may cause permanent damage;

② Efficiency is measured in nominal input voltage and rated output load;

③ The specified maximum capacitive load value for positive and negative output is identical.

20DAWE_1.5 series

20W - Single/Dual Output - Wide Input - Isolated & Regulated
DC-DC Converter

Typical characteristics

20DAWE_12110S1.5

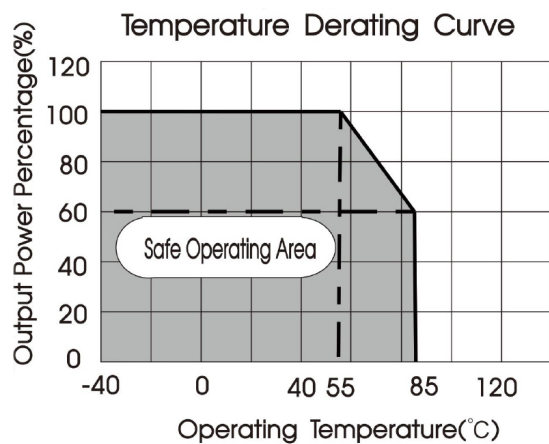

20DAWE_1215D1.5

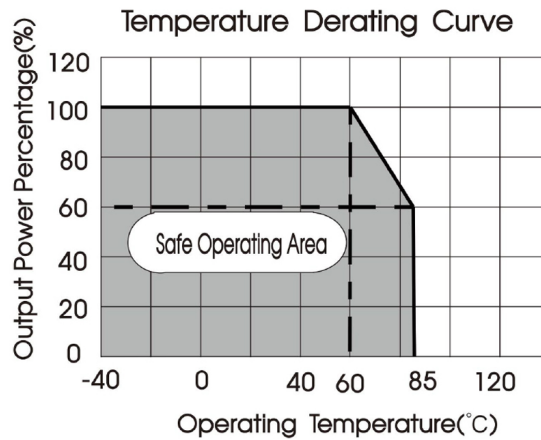

Others

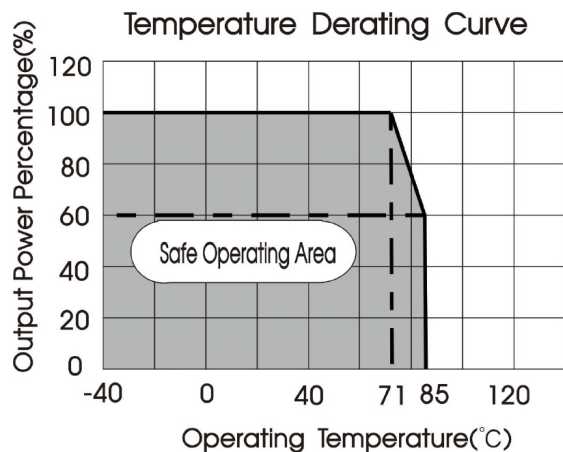

20DAWE_1.5 series

20W - Single/Dual Output - Wide Input - Isolated & Regulated
DC-DC Converter

Efficiency

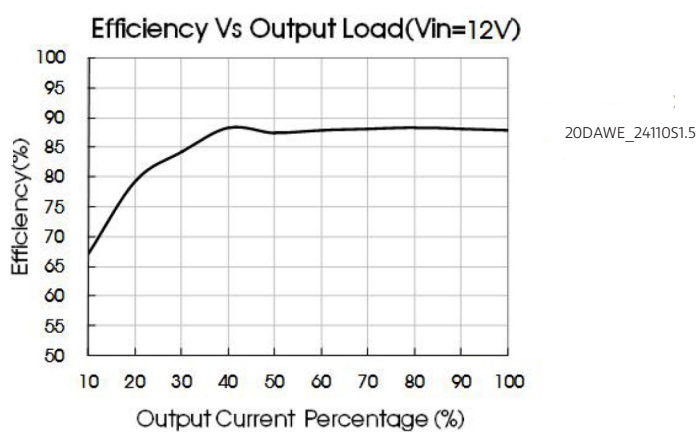
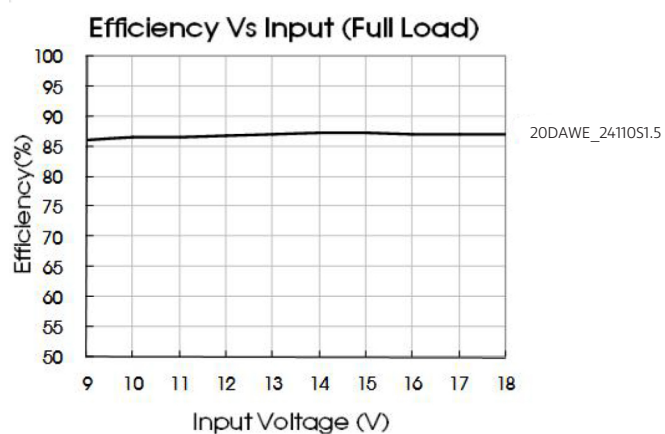
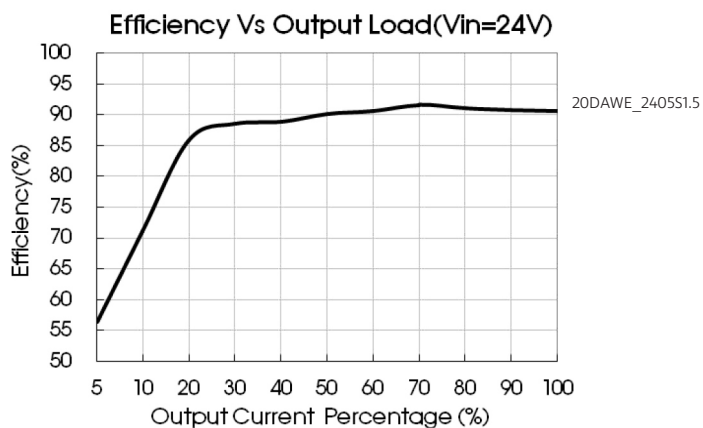
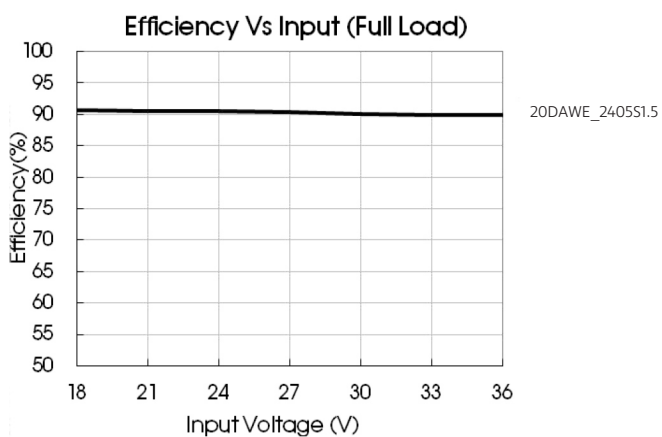
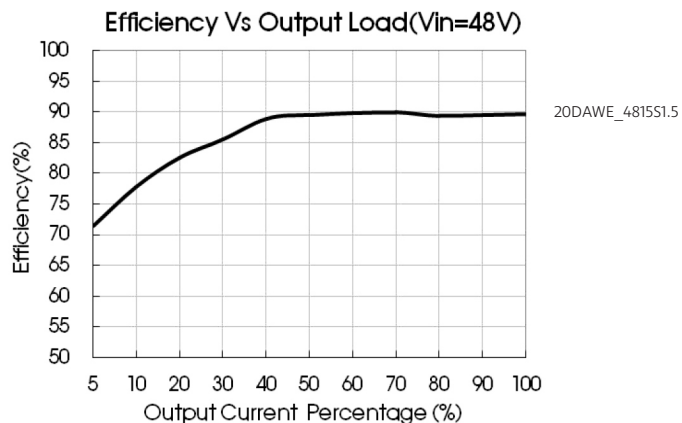
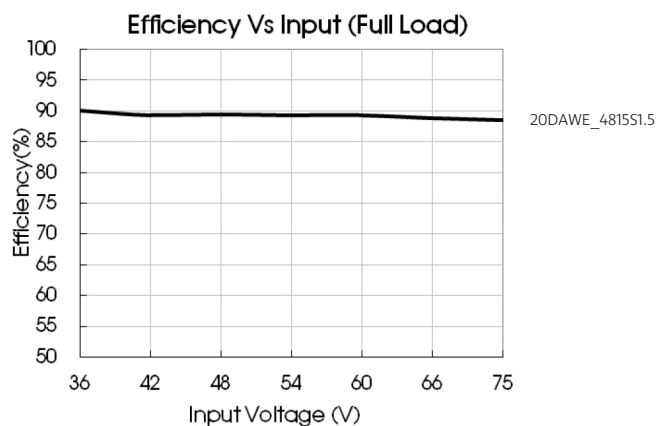

20DAWE_1.5 series

20W - Single/Dual Output - Wide Input - Isolated & Regulated DC-DC Converter

Typical application

All the DC/DC converters of this series are tested before delivery using the recommended circuit shown in Fig. 1.

Input and/or output ripple can be further reduced by appropriately increasing the input & output capacitor values C_{in} and C_{out} and/or by selecting capacitors with a low ESR (equivalent series resistance). Also make sure that the capacitance is not exceeding the specified max. capacitive load value of the product.

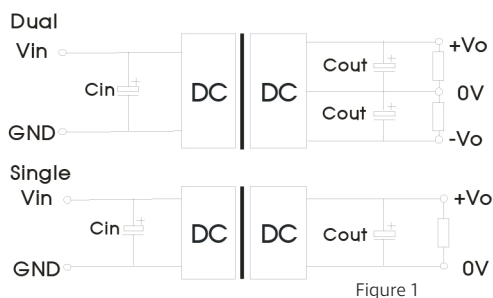

Single Vout (VDC)	Cout (μF)	Cin (μF)	Dual Vout (VDC)	Cout (μF)	Cin (μF)
3.3/5	470	100	±5	220	100
9/12/15	220		±9/±12/±15	100	
24	100		±24	100	
110	--				

Trim

Trim Function for Output Voltage Adjustment (open if unused)

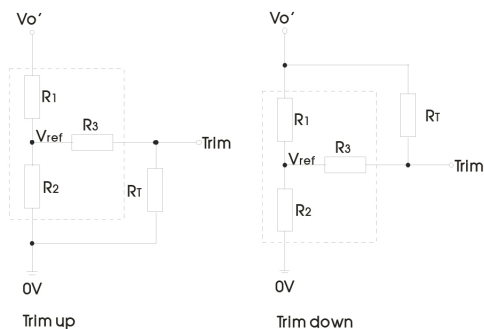

TRIM resistor connection (dashed line shows internal resistor network)

Calculating Trim resistor values:

$$\begin{aligned} \text{up: } R_T &= \frac{\alpha R_2}{R_2 - \alpha} \cdot R_3 & \alpha &= \frac{V_{ref}}{V_{o'} - V_{ref}} \cdot R_1 \\ \text{down: } R_T &= \frac{\alpha R_1}{R_1 - \alpha} \cdot R_3 & \alpha &= \frac{V_{o'} - V_{ref}}{V_{ref}} \cdot R_2 \end{aligned}$$

R_T = Trim Resistor value;
 α = self-defined parameter.

Vout(V)	R1(KΩ)	R2(KΩ)	R3(KΩ)	Vref(V)
3.3	4.801	2.87	12.4	1.24
5	2.883	2.87	10	2.5
9	7.500	2.87	15	2.5
12	11.000	2.87	15	2.5
15	14.494	2.87	15	2.5
24	24.872	2.87	17.8	2.5
110	130.43	3.00	22	2.5

The products do not support parallel connection of their output

20DAWE_1.5 series

20W - Single/Dual Output - Wide Input - Isolated & Regulated DC-DC Converter

EMC recommended circuit

Single:

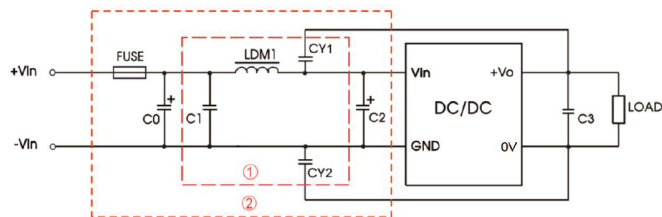

Dual:

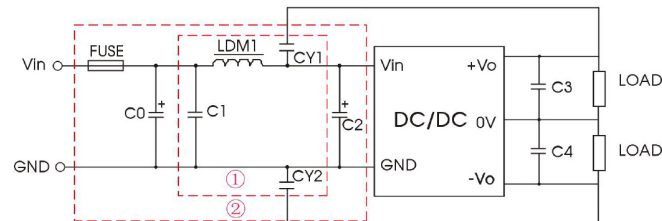

Parameter description

Model	Vin:12V/24V	Vin:48V
FUSE	Choose according to actual input current	
C0	680µF/100V	680µF/100V
C1	1µF/50V	1µF/100V
C2	330µF/50V	330µF/100V
C3 / C4	Refer to Cout in figure 1	
LDM1	4.7µH	
CY1/ CY2	1nF/2KV	

Mechanical dimensions

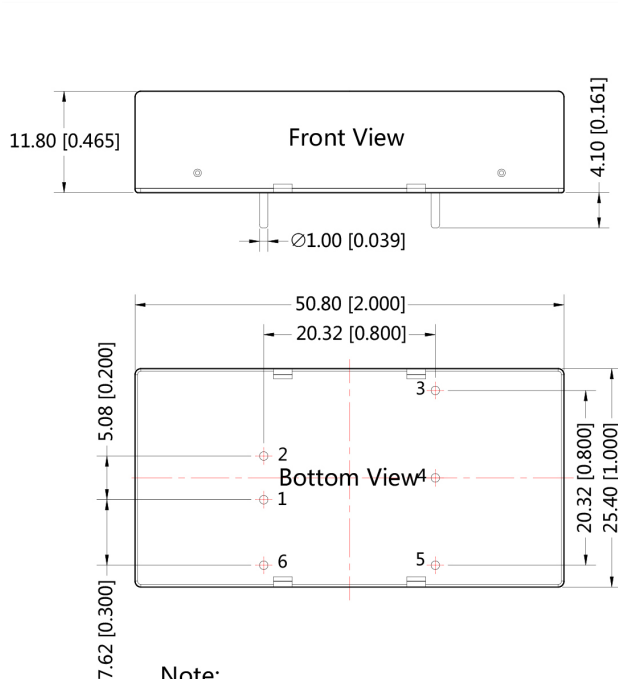

Note:
Unit :mm[inch]
Pin diameter tolerances :±0.10[±0.004]
General tolerances:±0.50[±0.020]

THIRD ANGLE PROJECTION

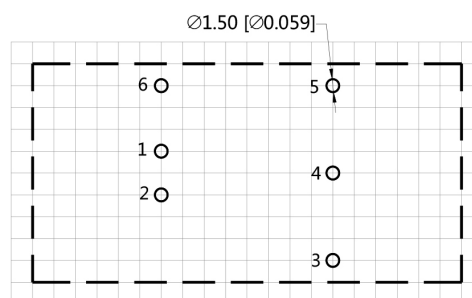

Note : Grid 2.54*2.54mm

Pin	Pin-Out	
	Single	Dual
1	GND	GND
2	Vin	Vin
3	+Vo	+Vo
4	Trim	0V
5	0V	-Vo
6	Ctrl	Ctrl

Note:

- We suggest to use module at load of over 5%, if not, the ripple of the product may exceeds the specification, but does not affect the reliability of the product;
- The maximum capacitive load offered were tested at input voltage range and full load;
- Unless otherwise specified, parameters in this datasheet were measured under the conditions of Ta=25°C, humidity<75%RH with nominal input voltage and rated output load;
- All index testing methods in this datasheet are based on company corporate standards;
- We can provide product customization service, please contact our technicians directly for specific information;
- Products are related to laws and regulations: see „Features“ and „EMC“;
- Our products shall be classified according to ISO14001 and related environmental laws and regulations, and shall be handled by qualified units.