

# TM7BDM16B

Discrete I/O expansion block, Modicon TM7,  
IP67, 16 DI/DO, 24 V DC, 0.5 A, M8 connector



## Main

Range of Product	Modicon TM7
Product or Component Type	Discrete I/O expansion block
Range Compatibility	Modicon M258 Modicon LMC058
Enclosure Material	Plastic
Bus type	TM7 bus
[Ue] rated operational voltage	24 V DC
Input/output number	16
Input/output number of block	16 I/O

## Complementary

Discrete input number	0...16 configurable by software
Discrete input voltage	24 V
Discrete input voltage type	DC
Discrete input current	4.4 mA
Discrete input logic	Positive
Discrete output number	0...16 (<= 0.5 A transistor configurable by software)
Discrete output voltage	24 V
Discrete output voltage type	DC
Sensor power supply	24 V, 500 mA for all channels overload, short-circuit and reverse polarity protection
Electrical connection	1 male connector M12 - B coding - 4 ways bus IN 1 female connector M12 - B coding - 4 ways bus OUT 1 male connector M8 - 4 ways power IN 1 female connector M8 - 4 ways power OUT 16 female connectors M8 - 3 ways sensor or actuator
Local signalling	For bus diagnostic 2 LEDs For sensor power supply diagnostics 2 LEDs
Operating position	Any position
Fixing Mode	By 2 screws
Net Weight	0.71 lb(US) (0.32 kg)

## Environment

Standards	IEC 61131-2
Product Certifications	C-tick ATEX II 3g EEx nA II T5 CURus GOST-R
Marking	CE
Ambient air temperature for operation	14...140 °F (-10...60 °C)
Ambient Air Temperature for Storage	-13...185 °F (-25...85 °C)
Relative humidity	5...95 % without condensation or dripping water
Pollution degree	2 IEC 60664
IP degree of protection	IP67 conforming to IEC 61131-2
Operating altitude	0...6561.68 ft (0...2000 m)
Storage altitude	0.00...9842.52 ft (0...3000 m)

Vibration resistance	7.5 mm constant amplitude 2...8 Hz)IEC 60721-3-5 Class 5M3 2 gn constant acceleration 8...200 Hz)IEC 60721-3-5 Class 5M3 4 gn constant acceleration 200...500 Hz)IEC 60721-3-5 Class 5M3
Shock resistance	30 gn 11 ms IEC 60721-3-5 Class 5M3
Electromagnetic compatibility	Electrostatic discharge immunity test, 4 kV on contact EN/IEC 61000-4-2 Electrostatic discharge immunity test, 8 kV in air EN/IEC 61000-4-2 Susceptibility to electromagnetic fields, 1 V/m 2...2.7 GHz EN/IEC 61000-4-3 Susceptibility to electromagnetic fields, 10 V/m 80...2000 MHz EN/IEC 61000-4-3 Electrical fast transient/burst immunity test, 2 kV power supply EN/IEC 61000-4-4 Electrical fast transient/burst immunity test, 1 kV input/output EN/IEC 61000-4-4 Electrical fast transient/burst immunity test, 1 kV shielded cable EN/IEC 61000-4-4 1.2/50 µs shock waves immunity test, 0.5 kV power supply (common mode) EN/IEC 61000-4-5 1.2/50 µs shock waves immunity test, 1 kV power supply (differential mode) EN/IEC 61000-4-5 1.2/50 µs shock waves immunity test, 0.5 kV unshielded links (common mode) EN/IEC 61000-4-5 1.2/50 µs shock waves immunity test, 1 kV unshielded links (differential mode) EN/IEC 61000-4-5 1.2/50 µs shock waves immunity test, 0.5 kV shielded links (common mode) EN/IEC 61000-4-5 1.2/50 µs shock waves immunity test, 1 kV shielded links (differential mode) EN/IEC 61000-4-5 Conducted RF disturbances EN/IEC 61000-4-6 Conducted and radiated emissions CISPR 11





## Ordering and shipping details

Category	22532 - M258 PLC
Discount Schedule	PC12
GTIN	3595864093109
Nbr. of units in pkg.	1
Package weight(Lbs)	12.63 oz (358 g)
Returnability	No
Country of origin	AT

## Packing Units

Unit Type of Package 1	PCE
Package 1 Height	1.77 in (4.5 cm)
Package 1 width	2.17 in (5.5 cm)
Package 1 Length	6.89 in (17.5 cm)
Unit Type of Package 2	S03
Number of Units in Package 2	30
Package 2 Weight	24.56 lb(US) (11.14 kg)
Package 2 Height	11.81 in (30 cm)
Package 2 width	11.81 in (30 cm)
Package 2 Length	15.75 in (40 cm)

## Offer Sustainability

Sustainable offer status	Green Premium product
California proposition 65	WARNING: This product can expose you to chemicals including: Lead and lead compounds, which is known to the State of California to cause cancer and birth defects or other reproductive harm. For more information go to <a href="http://www.P65Warnings.ca.gov">www.P65Warnings.ca.gov</a>
REACH Regulation	 <a href="#">REACH Declaration</a>
REACH free of SVHC	Yes
EU RoHS Directive	Pro-active compliance (Product out of EU RoHS legal scope)  <a href="#">EU RoHS Declaration</a>
Toxic heavy metal free	Yes
Mercury free	Yes
RoHS exemption information	 Yes
China RoHS Regulation	 <a href="#">China RoHS Declaration</a>

Environmental Disclosure	<a href="#">Product Environmental Profile</a>
Circularity Profile	<a href="#">End Of Life Information</a>
WEEE	The product must be disposed on European Union markets following specific waste collection and never end up in rubbish bins.
PVC free	Yes

### Contractual warranty

Warranty	18 months
----------	-----------

Digital Mixed Block

Description

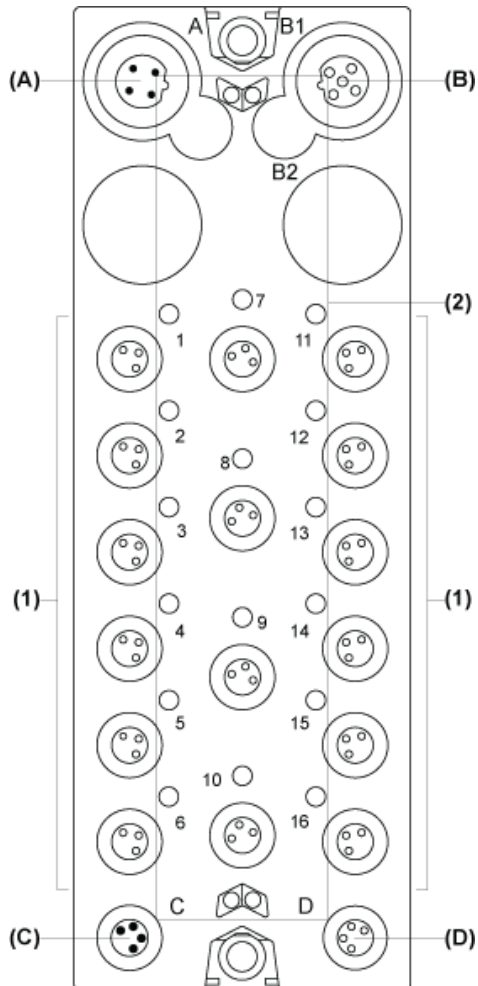

- (A) TM7 bus IN connector
- (B) TM7 bus OUT connector
- (C) 24 Vdc power IN connector
- (D) 24 Vdc power OUT connector
- (1) Input / Output connectors
- (2) Status LEDs

Connector and Channel Assignments

I/O connectors	Channel types	Channels
1	Input / Output	I0 / Q0
2	Input / Output	I1 / Q1
3	Input / Output	I2 / Q2
4	Input / Output	I3 / Q3
5	Input / Output	I4 / Q4
6	Input / Output	I5 / Q5
7	Input / Output	I6 / Q6
8	Input / Output	I7 / Q7
9	Input / Output	I8 / Q8

I/O connectors	Channel types	Channels
10	Input / Output	I9 / Q9
11	Input / Output	I10 / Q10
12	Input / Output	I11 / Q11
13	Input / Output	I12 / Q12
14	Input / Output	I13 / Q13
15	Input / Output	I14 / Q14
16	Input / Output	I15 / Q15

TM7 Block, Size 2

Dimensions

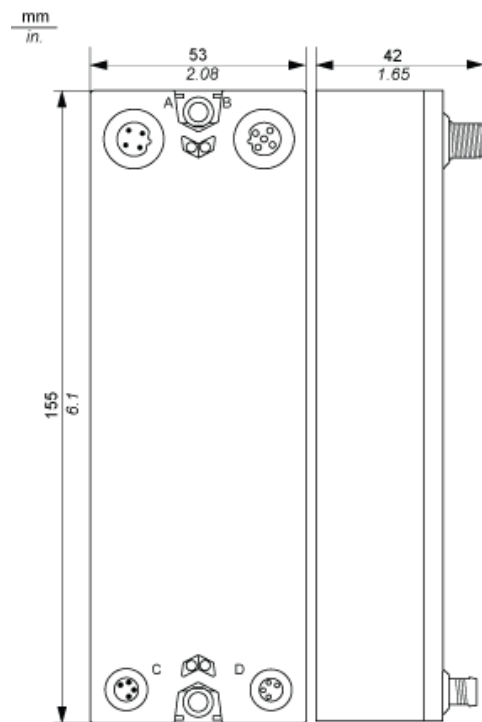

Spacing Requirements

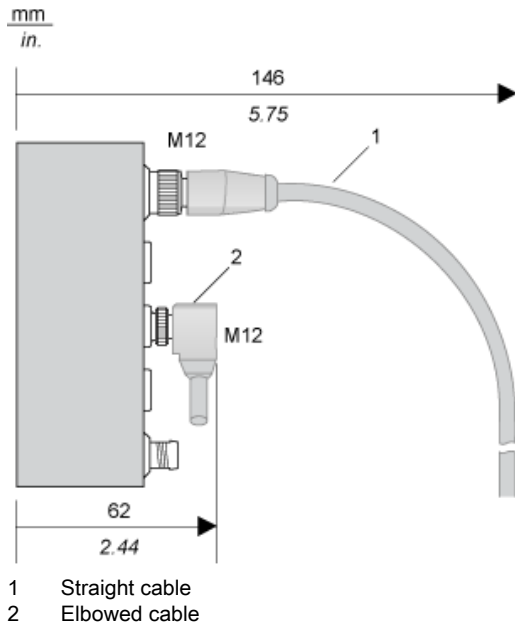

Installation Guidelines

TM7 Block on an Aluminium Frame

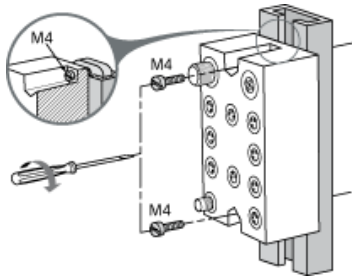

NOTE: Maximum torque to fasten the required M4 screws is 0.6 N.m (5.3 lbf-in).

TM7 Block on a DIN Rail

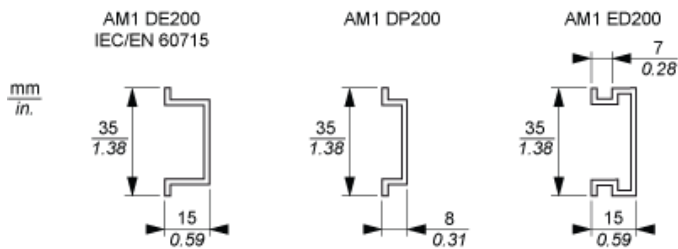

NOTE: Only size 1 (smallest) blocks can be installed on DIN rail with the TM7ACMP mounting plate.

## TM7 Block Directly on the Machine

Drilling template of the block:

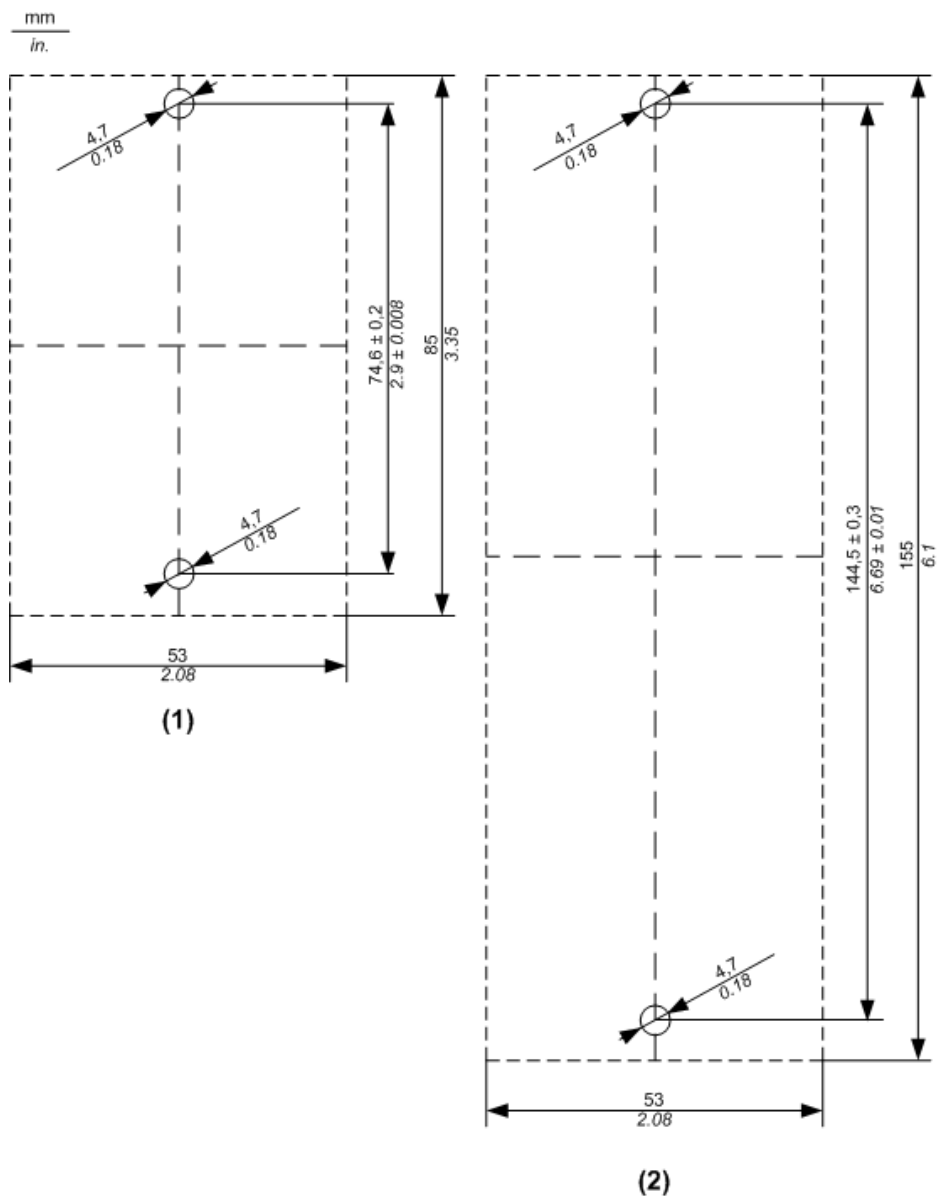

- (1) Size 1
- (2) Size 2

The thickness of the base plate should be taken into consideration when defining the screw length.

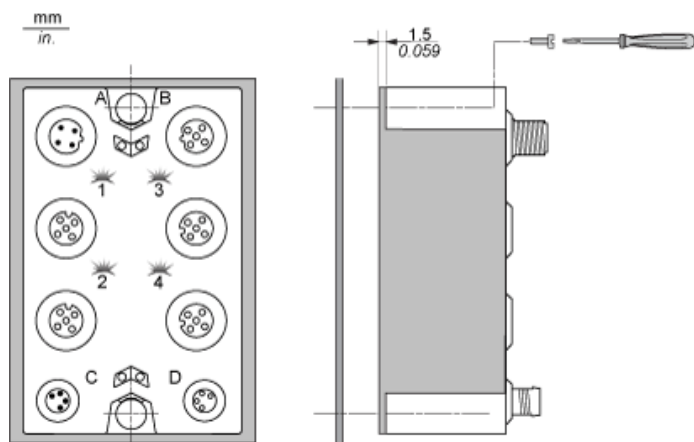

NOTE: Maximum torque to fasten the required M4 screws is 0.6 N.m (5.3 lbf-in).



Wiring Diagram

Pin Assignments for I/O Connectors

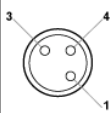
Connection	Pin	M8 input / output
	1	24 Vdc sensor / actuator supply
3	0 Vdc	
4	DI/DO: input/ output signal	

Wiring the Power Supply

When you provide power to a TM7 I/O block using the 24 VDC Power OUT connector of the preceding I/O block, both blocks occupy the same 24 Vdc I/O power segment. However, if you connect an external isolated power supply to the 24 Vdc Power IN connector of a TM7 I/O block, you establish a new 24 Vdc I/O power segment beginning with that I/O block.

I/O block wired with one external 24 Vdc power supply:

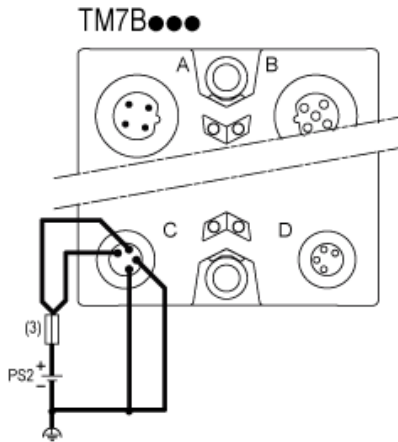

- (3) External fuse, Type T slow-blow, 8 A max., 250 V
- PS2 External isolated I/O power supply, 24 Vdc

Switching Inductive Load Characteristics

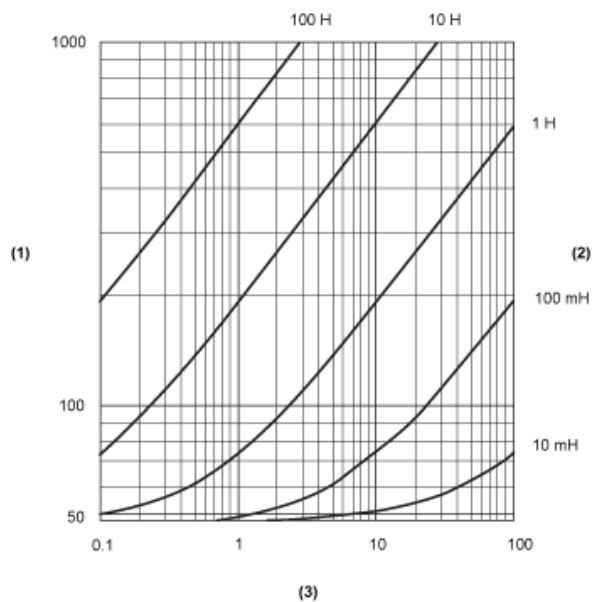

- (1) Load resistance in  $\Omega$
- (2) Load inductance in H
- (3) Max. operating cycles / second