

WLS28-2 UV LED Strip Light

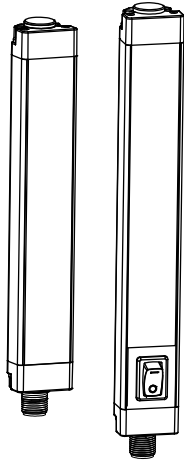

Datasheet



Banner's WLS28-2 UV LED Strip Lights have sturdy aluminum housings, shatterproof windows, and impressive environmental ratings, making them a cost-effective operator inspection light or machine vision light to improve and enhance contrast in UV fluorescent and non-fluorescent applications.

- UV 365 nm and 395 nm wavelength models available for diverse applications
- Low-profile, space-saving design
- Rugged, water-resistant IP69K option
- Available in four lengths from 285 mm to 1130 mm (11.22 in to 3.7 ft)
- Lensed models available on UV395 models
- Daisy chain power to multiple lights
- Safe for long-term worker operation
- Optional snap clips for easy installation and repositioning
- Capability to dim lights using the wiring pinout (Hi/Lo/Off)
- Optional switch is now Hi/Lo/Off
- Automatic temperature protection built into the unit. Above 50 °C, the light dims to manage heat and protect product lifetime
- PWM models can be used for strobed operation



Note: When cascading lights, a model with an ON/OFF switch can be used to control the lights cascaded off the switched model.

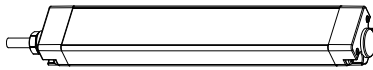

Stand-Alone Light—cable

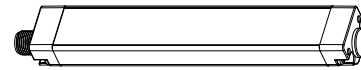

Stand-Alone Light or End Light in a Cascade—QD

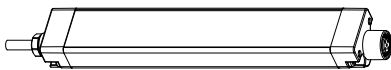

First Light in a Cascade—cable

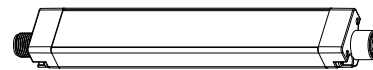

First or Middle of a Cascade—QD

These Work Light Strips are available as either stand-alone models, or as cascade models that can be daisy-chained together for a continuous length of lighting, with a minimum of wiring.

Stand-alone models have cable or male quick disconnect (QD) at one end for power connection and no connections at opposite end. A stand-alone model may be used as the last in the cascade series.

Cascade models have cable or male quick disconnect (QD) at one end for power connection and a female quick disconnect (QD) at the opposite end for connecting to other lights in the cascade. Cascade models with cable end can only be used as the first light in the cascade series. A double-ended accessory cordset must be used between each pair of lights in a cascade.



Important: Lea el siguiente instructivo antes de operar el luminario. Por favor descargue desde www.bannerengineering.com toda la documentación técnica de los WLS28-2 UV LED Strip Light, disponibles en múltiples idiomas, para detalles del uso adecuado, aplicaciones, advertencias, y las instrucciones de instalación de estos dispositivos.



Important: Lisez les instructions suivantes avant d'utiliser le luminare. Veuillez télécharger la documentation technique complète des WLS28-2 UV LED Strip Light sur notre site www.bannerengineering.com pour les détails sur leur utilisation correcte, les applications, les notes de sécurité et les instructions de montage.



Models

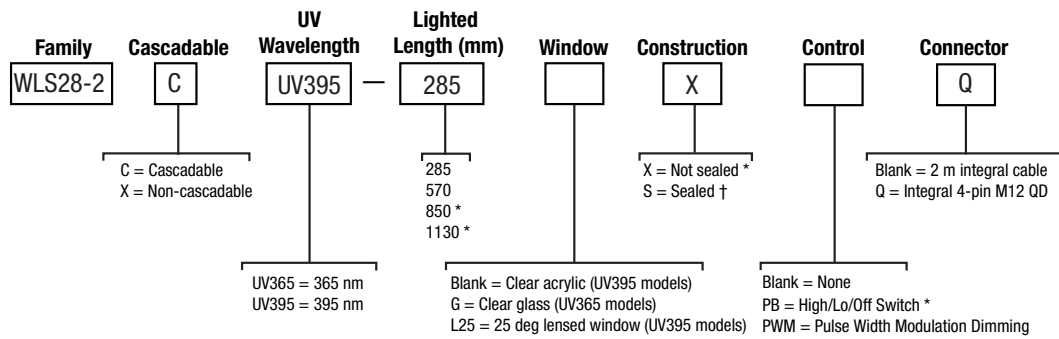

* Not available in UV365 models
 † Sealed models not available with Hi/Lo/Off

Table 1: IEC IP50 Models

Non-Switch Models ¹		HIGH/OFF/LOW Switch Models ¹		PWM Models ¹		Lighted Length	Wavelength
Stand-Alone	Cascade	Stand-Alone	Cascade	Stand-Alone	Cascade		
WLS28-2XUV395-285X	WLS28-2CUV395-285X	WLS28-2XUV395-285XPB	WLS28-2CUV395-285XPB	WLS28-2XUV395-2855XPWM	WLS28-2CUV395-2855XPWM	285 mm	395 nm
WLS28-2XUV395-570X	WLS28-2CUV395-570X	WLS28-2XUV395-570XPB	WLS28-2CUV395-570XPB	WLS28-2XUV395-5705XPWM	WLS28-2CUV395-5705XPWM	570 mm	
WLS28-2XUV395-850X	WLS28-2CUV395-850X	WLS28-2XUV395-850XPB	WLS28-2CUV395-850XPB	WLS28-2XUV395-8505XPWM	WLS28-2CUV395-8505XPWM	850 mm	
WLS28-2XUV395-1130X	WLS28-2CUV395-1130X	WLS28-2XUV395-1130XPB	WLS28-2CUV395-1130XPB	WLS28-2XUV395-11305XPWM	WLS28-2CUV395-11305XPWM	1130 mm	

Table 2: IEC IP67/IP69K Models

Non-Switch Models ¹		PWM Models ¹		Lighted Length	Wavelength
Stand-Alone	Cascade	Stand-Alone	Cascade		
WLS28-2XUV365-285GS	WLS28-2CUV365-285GS	WLS28-2XUV365-285GSPWM	WLS28-2CUV365-285GSPWM	285 mm	365 nm
WLS28-2XUV365-570GS	WLS28-2CUV365-570GS	WLS28-2XUV365-570GSPWM	WLS28-2CUV365-570GSPWM	570 mm	
WLS28-2XUV395-285S	WLS28-2CUV395-285S	WLS28-2XUV395-285SPWM	WLS28-2CUV395-285SPWM	285 mm	395 nm
WLS28-2XUV395-570S	WLS28-2CUV395-570S	WLS28-2XUV395-570SPWM	WLS28-2CUV395-570SPWM	570 mm	
WLS28-2XUV395-850S	WLS28-2CUV395-850S	WLS28-2XUV395-850SPWM	WLS28-2CUV395-850SPWM	850 mm	
WLS28-2XUV395-1130S	WLS28-2CUV395-1130S	WLS28-2XUV395-1130SPWM	WLS28-2CUV395-1130SPWM	1130 mm	

Wiring Diagram

Male	Female	Pin	Wire Color	Connection
		1	brown	12 to 30 V dc
		3	blue	dc common
		4	black	Models without the switch or PWM: Connect to 12 to 30 V dc for 50% maximum intensity Models with PWM: Connect to 8 to 30 V dc to turn the light off; connect to dc common or leave floating to turn the light on.
		2	white	Not used

For maximum intensity, leave the black wire floating or connected to common.

¹ Integral 2 m (6.5 ft) unterminated cable models are listed. To order the 4-pin M12/Euro-style integral quick disconnect model, add the suffix "Q" to the model number. For example, WLS28-2XUV395-285XQ.

Specifications

Supply Voltage and Current

12 V dc to 30 V dc
 Use only with a suitable Class 2 power supply (UL) or SELV power supply (CE)
 See electrical characteristics on product label

Supply Protection Circuitry

Protected against reverse polarity and transient voltages

Light Characteristics

UV365: 360–370 nm
 UV395: 390–400 nm

LED Lifetime

Lumen Maintenance – L₇₀
 When operating within specifications, output will decrease less than 30% after 40,000 hours.

Push Button

II = 100% light intensity
 I = 50% light intensity
 0 = Off

Pulse Width Modulation (PWM)

Frequency: Up to 1000 Hz
 Voltage: 8 V dc to 30 V dc
 Current: 4 mA maximum per foot

Construction

Clear anodized aluminum housing; painted zinc end caps; zinc plated steel brackets
 Window for UV365 models: tempered borosilicate glass
 Window for UV395 models: acrylic

Mounting

(2) swivel brackets SMBWLS28RA included and (4) screws

Connections

Integral 4-pin M12/Euro-style male quick disconnect (4-pin connecting cordset required); or 2 m (6.5 ft) integral PVC cable



Note: This product emits UV light. Exempt Risk Group (RG 0) product. No optical hazard is considered reasonably foreseeable, even for continuous, unrestricted use (IEC 62471).

Environmental Rating

IEC IP50 (non-sealed models) or IEC IP65, IEC IP67, IP69K per DIN 40050-9 (sealed models)

Vibration and Mechanical Shock

Vibration: 10 Hz to 55 Hz, 1.0 mm peak-to-peak amplitude per IEC 60068-2-6
 Shock: 15G 11 ms duration, half sine wave per IEC 60068-2-27

Operating Temperature

–40 °C to +70 °C (–40 °F to +158 °F)
 Light output begins to decrease above 50 °C (122 °F) and will be approximately 65% of max intensity at 60 °C (140 °F) and 30% of max intensity at 70 °C (158 °F)

Storage Temperature

–40 °C to +70 °C (–40 °F to +158 °F)

Certifications



Sealed models only

Application Note

When connecting cascading lights in series at 100% intensity, it is important not to exceed maximum current limitations:

Maximum length of light at 12 V dc: 1.4 m (4.6 ft)
 Maximum length of light at 24 V dc: 3.0 m (9.8 ft)
 Maximum length of light at 30 V dc: 3.1 m (10.2 ft)

At 50% intensity, double the lengths.



Note: Do not spray cable with high-pressure sprayer, or cable damage will result.

Table 3: Typical Current

Light Length	Typical Current			Max. Current A	Radiant Flux (mW) (Typical at 25 °C)	
	12 V dc	24 V dc	30 V dc		UV365	UV395
285 mm	0.66 A	0.30 A	0.24 A	0.8	250	850
570 mm	1.36 A	0.61 A	0.48 A	1.6	500	1700
850 mm	2.13 A	0.92 A	0.73 A	2.4	-	2550
1130 mm	3.04 A	1.24 A	0.97 A	3.2	-	3400

Dimensions

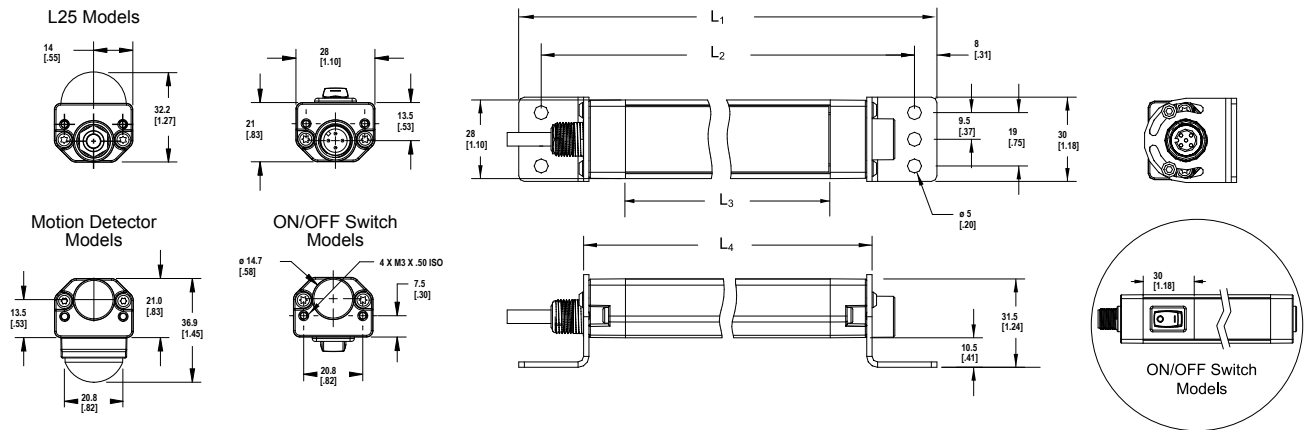

Dimensions are shown with the included SMBWLS28RA bracket.

Non-Switch Models					
IP50 Models	IP67/IP69K Models	L ₁	L ₂	L ₃	L ₄
WLS28-2..285X	WLS28-2..285S	362 mm (14.3 in)	346 mm (13.6 in)	286 mm (11.26 in)	316 mm (12.4 in)
WLS28-2..570X	WLS28-2..570S	644 mm (25.4 in)	628 mm (24.7 in)	568 mm (22.36 in)	598 mm (23.5 in)
WLS28-2..850X	WLS28-2..850S	926 mm (36.5 in)	910 mm (35.8 in)	850 mm (33.46 in)	880 mm (34.6 in)
WLS28-2..1130X	WLS28-2..1130S	1208 mm (47.6 in)	1192 mm (46.9 in)	1132 mm (44.57 in)	1162 mm (45.7 in)

ON/OFF Switch Models				
Model	L ₁	L ₂	L ₃	L ₄
WLS28-2..285XPB	392 mm (15.4 in)	376 mm (14.8 in)	286 mm (11.26 in)	346 mm (13.6 in)
WLS28-2..570XPB	674 mm (26.5 in)	658 mm (25.9 in)	568 mm (22.36 in)	628 mm (24.7 in)
WLS28-2..850XPB	956 mm (37.6 in)	940 mm (37 in)	850 mm (33.46 in)	910 mm (35.8 in)
WLS28-2..1130XPB	1238 mm (48.7 in)	1222 mm (48.1 in)	1132 mm (44.57 in)	1192 mm (46.9 in)

Accessories

Cordsets

Use single-ended cordsets between the power source and the QD connection of a stand-alone light or the first light in a cascade. Use double-ended cordsets between lights in a cascade.

4-Pin Threaded M12/Euro-Style Cordsets—Single Ended				
Model	Length	Style	Dimensions	Pinout (Female)
MQDC-406	1.83 m (6 ft)	Straight		
MQDC-415	4.57 m (15 ft)			
MQDC-430	9.14 m (30 ft)			
MQDC-450	15.2 m (50 ft)			

1 = Brown
2 = White
3 = Blue
4 = Black

4-Pin Threaded M12/Euro-Style Cordsets—Single Ended				
Model	Length	Style	Dimensions	Pinout (Female)
MQDC-406RA	1.83 m (6 ft)	Right-Angle		
MQDC-415RA	4.57 m (15 ft)			
MQDC-430RA	9.14 m (30 ft)			
MQDC-450RA	15.2 m (50 ft)			

4-Pin Threaded M12/Euro-Style Cordsets—Double Ended				
Model	Length	Style	Dimensions	Pinout
MQDEC-401SS	0.31 m (1 ft)	Male Straight/ Female Straight		Female
MQDEC-403SS	0.91 m (3 ft)			
MQDEC-406SS	1.83 m (6 ft)			Male
MQDEC-412SS	3.66 m (12 ft)			
MQDEC-420SS	6.10 m (20 ft)			
MQDEC-430SS	9.14 m (30 ft)			
MQDEC-450SS	15.2 m (50 ft)			
				1 = Brown 2 = White 3 = Blue 4 = Black

4-Pin Threaded M12/Euro-Style Splitter Cordsets—Flat Junction				
Model	Branches (Female)	Trunk (Male)	Pinout	
CSB-M1240M1240	No branch	No trunk	 Male 1 = Brown 2 = White 3 = Blue 4 = Black	
CSB-M1240M1241	2 x 0.30 m (1 ft)	No trunk		
CSB-M1241M1241		0.30 m (1 ft)		
CSB-M1248M1241		2.50 m (8 ft)		
CSB-M12415M1241		4.57 m (15 ft)		
CSB-M12425M1241		7.60 m (25 ft)		
CSB-UNT425M1241		7.60 m (25 ft) unterminated		

Brackets

SMBWLS28RA

The bracket kit is available as a replacement for the one that comes with the light or switch. The kit contains two end brackets and four screws.

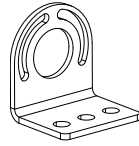

SMBWLS28SM

This kit allows the light or switch to be mounted at a right angle to the mounting surface. The kit contains two end brackets and four screws.

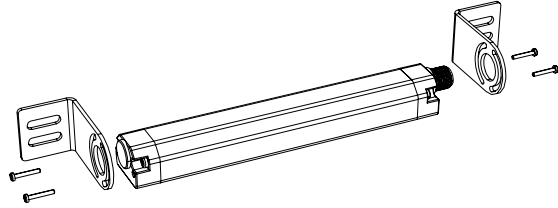

SMBWLS28SP

- Stainless steel snap bracket kit
- Includes two brackets

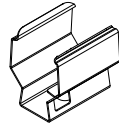

SMH1316

This kit allows the light or switch to be mounted to a 13/16-inch Unistrut channel. Light is shown. The kit includes:

- #10-32 spring nuts (qty 2)
- #10-32 socket head cap screws (qty 2)
- #10 lock washers (qty 2)

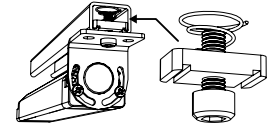

SMBWLSMAG

Magnetic mounting bracket for easy attachment to steel surfaces

SMBWLSMAGR

Protective cover also available to prevent scratches to painted surfaces

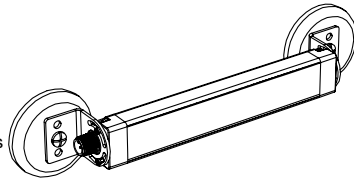

Banner Engineering Corp. Limited Warranty

Banner Engineering Corp. warrants its products to be free from defects in material and workmanship for one year following the date of shipment. Banner Engineering Corp. will repair or replace, free of charge, any product of its manufacture which, at the time it is returned to the factory, is found to have been defective during the warranty period. This warranty does not cover damage or liability for misuse, abuse, or the improper application or installation of the Banner product.

THIS LIMITED WARRANTY IS EXCLUSIVE AND IN LIEU OF ALL OTHER WARRANTIES WHETHER EXPRESS OR IMPLIED (INCLUDING, WITHOUT LIMITATION, ANY WARRANTY OF MERCHANTABILITY OR FITNESS FOR A PARTICULAR PURPOSE), AND WHETHER ARISING UNDER COURSE OF PERFORMANCE, COURSE OF DEALING OR TRADE USAGE.

This Warranty is exclusive and limited to repair or, at the discretion of Banner Engineering Corp., replacement. **IN NO EVENT SHALL BANNER ENGINEERING CORP. BE LIABLE TO BUYER OR ANY OTHER PERSON OR ENTITY FOR ANY EXTRA COSTS, EXPENSES, LOSSES, LOSS OF PROFITS, OR ANY INCIDENTAL, CONSEQUENTIAL OR SPECIAL DAMAGES RESULTING FROM ANY PRODUCT DEFECT OR FROM THE USE OR INABILITY TO USE THE PRODUCT, WHETHER ARISING IN CONTRACT OR WARRANTY, STATUTE, TORT, STRICT LIABILITY, NEGLIGENCE, OR OTHERWISE.**

Banner Engineering Corp. reserves the right to change, modify or improve the design of the product without assuming any obligations or liabilities relating to any product previously manufactured by Banner Engineering Corp. Any misuse, abuse, or improper application or installation of this product or use of the product for personal protection applications when the product is identified as not intended for such purposes will void the product warranty. Any modifications to this product without prior express approval by Banner Engineering Corp will void the product warranties. All specifications published in this document are subject to change; Banner reserves the right to modify product specifications or update documentation at any time. Specifications and product information in English supersede that which is provided in any other language. For the most recent version of any documentation, refer to: www.bannerengineering.com.

For patent information, see www.bannerengineering.com/patents.

Mexican Importer

Banner Engineering de México, S. de R.L. de C.V.
David Alfaro Siqueiros 103 Piso 2 Valle oriente
San Pedro Garza García Nuevo León, C. P. 66269

81 8363.2714