

AMY-25-ZOOM

Ø25 mm zoomable lens with infinitely adjustable beam from 20 to 50 degrees

SPECIFICATION:

Dimensions	25.0 x 25.0 mm
Height	12 mm
Fastening	tape
ROHS compliant	yes ⓘ

MATERIALS:

Component	Type	Material	Colour	Finish
C18547_AMY-25-ZOOM-SUB	Single lens	PMMA		
CA18549_AMY-25-ZOOM	Assembly			

ORDERING INFORMATION:

Quantities for one set:

Single lens	1
Assembly	1



Component		Qty in box	MOQ	MPQ	Box weight (kg)
C18547_AMY-25-ZOOM-SUB » Box size: 480 x 280 x 185 mm	Single lens	3375	135	135	5.4
CA18549_AMY-25-ZOOM » Box size: 480 x 280 x 300 mm	Assembly	3375	135	135	12.7

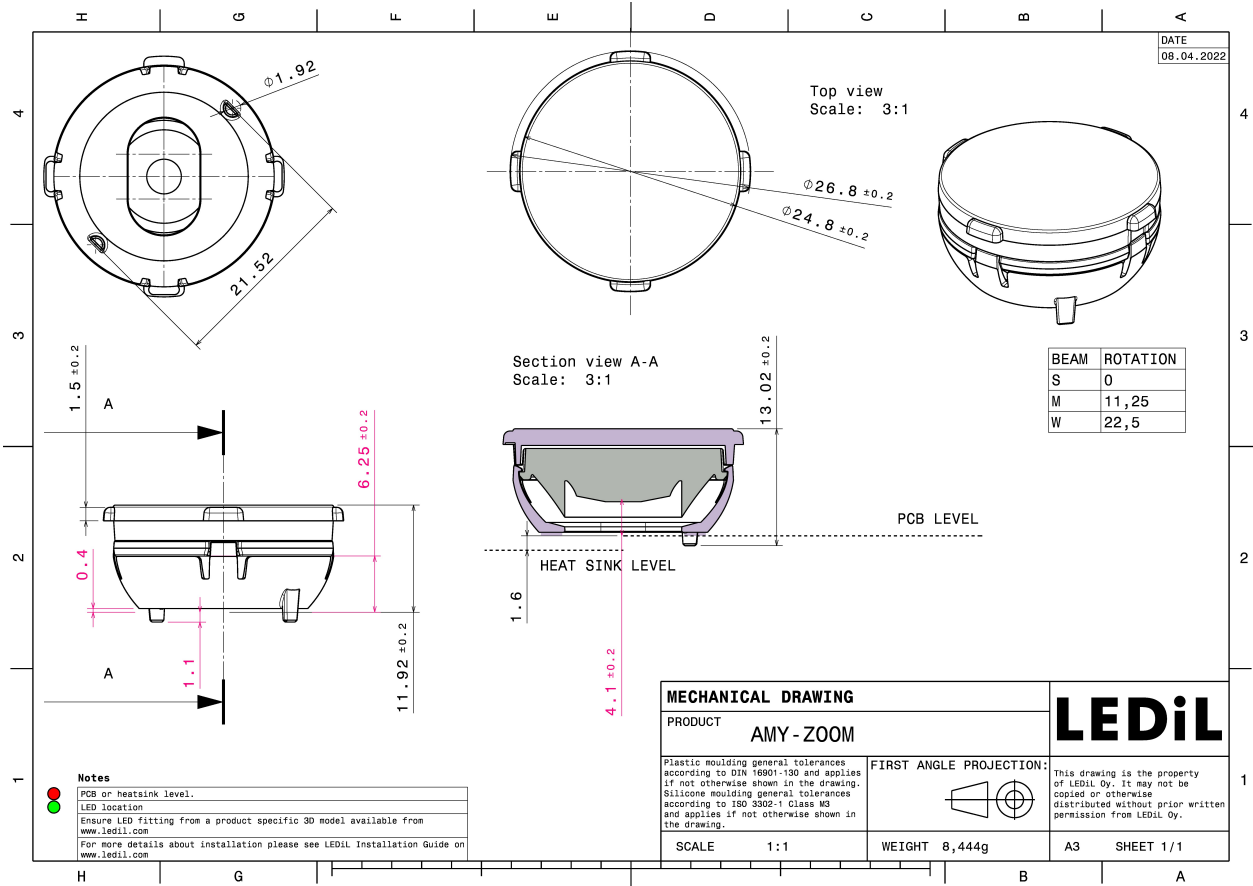

See also our general installation guide: www.ledil.com/installation_guide

OPTICAL RESULTS (MEASURED):





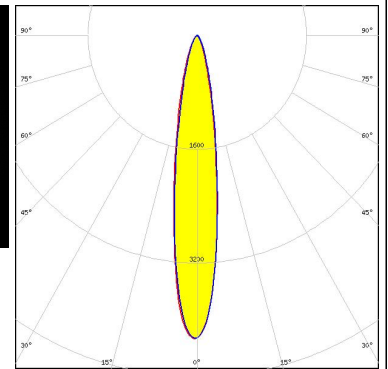

LED SST-40
FWHM / FWTM 17.0 + 49.0° / 40.0 + 76.0°
Efficiency 75 %
Peak intensity 4.3 cd/lm
LEDs/each optic 1
Light colour White
Required components:

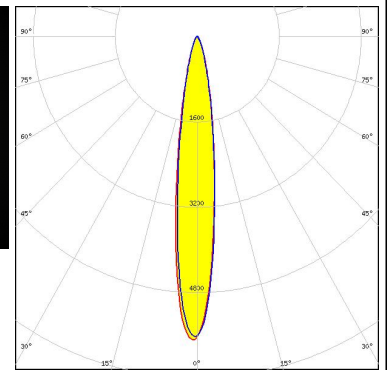
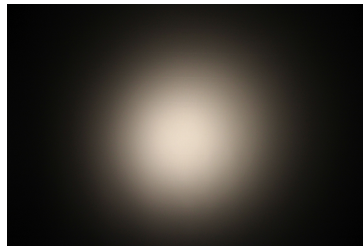

LED NVSW719AC
FWHM / FWTM 15.0 + 46.0° / 35.0 + 71.0°
Efficiency 76 %
Peak intensity 5.7 cd/lm
LEDs/each optic 1
Light colour White
Required components:

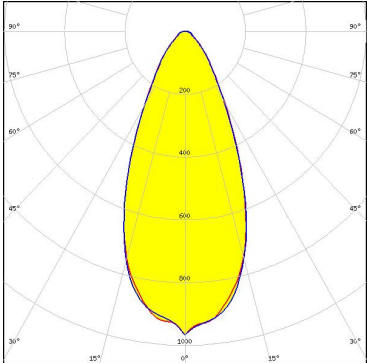
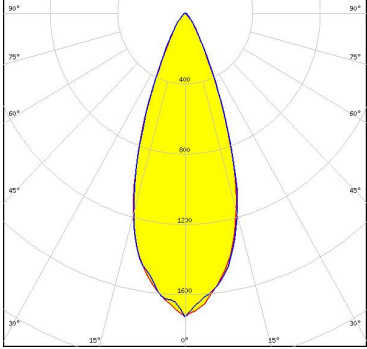

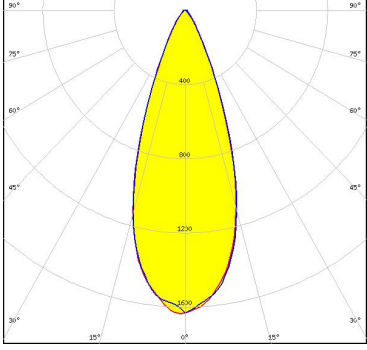
OPTICAL RESULTS (SIMULATED):

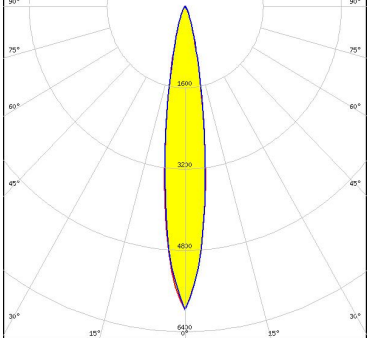
<p> LED CSP 2727 (BXCP)</p> <p>FWHM / FWTM 36.0 + 57.0° / 72.0 + 97.0°</p> <p>Efficiency 75 %</p> <p>Peak intensity 1.4 cd/lm</p> <p>LEDs/each optic 4</p> <p>Light colour White</p> <p>Required components:</p>	
<p>CITIZEN</p> <p>LED CLU7B2</p> <p>FWHM / FWTM 18.0 + 52.0° / 40.0 + 77.0°</p> <p>Efficiency 81 %</p> <p>Peak intensity 4.8 cd/lm</p> <p>LEDs/each optic 1</p> <p>Light colour White</p> <p>Required components:</p>	
<p> LED XHP35.2 HI</p> <p>FWHM / FWTM 18.0 + 51.0° / 38.0 + 78.0°</p> <p>Efficiency 80 %</p> <p>Peak intensity 4.8 cd/lm</p> <p>LEDs/each optic 1</p> <p>Light colour White</p> <p>Required components:</p>	
<p> LED XP-G3</p> <p>FWHM / FWTM 16.0 + 49.0° / 34.0 + 80.0°</p> <p>Efficiency 80 %</p> <p>Peak intensity 6 cd/lm</p> <p>LEDs/each optic 1</p> <p>Light colour White</p> <p>Required components:</p>	

OPTICAL RESULTS (SIMULATED):



LED XP-L HD
 FWHM / FWTM 18.0 + 50.0° / 38.0 + 82.0°
 Efficiency 82 %
 Peak intensity 5.1 cd/lm
 LEDs/each optic 1
 Light colour White
 Required components:

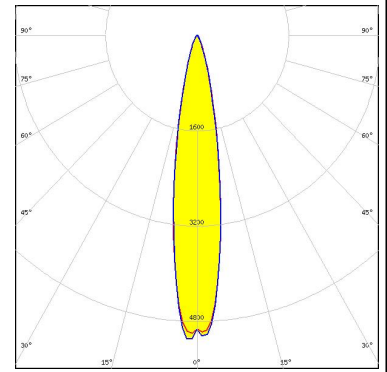

LED LUXEON HL2X
 FWHM / FWTM 16.0 + 50.0° / 34.0 + 70.0°
 Efficiency 84 %
 Peak intensity 6.3 cd/lm
 LEDs/each optic 1
 Light colour White
 Required components:

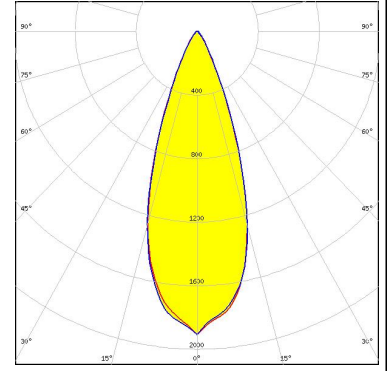

LED SFT-40-WCS
 FWHM / FWTM 14.0 + 48.0° / 28.0 + 71.0°
 Efficiency 86 %
 Peak intensity 9.3 cd/lm
 LEDs/each optic 1
 Light colour White
 Required components:

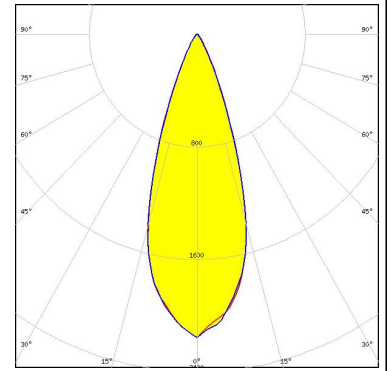

LED SFT-70X-WCS
 FWHM / FWTM 16.0 + 51.0° / 32.0 + 74.0°
 Efficiency 84 %
 Peak intensity 7 cd/lm
 LEDs/each optic 1
 Light colour White
 Required components:

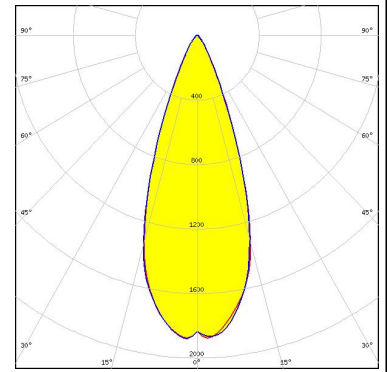

OPTICAL RESULTS (SIMULATED):

<p>NICHIA</p> <p>LED: NV4WB35AM</p> <p>FWHM / FWTM: 18.0 + 52.0° / 38.0 + 78.0°</p> <p>Efficiency: 81 %</p> <p>Peak intensity: 5 cd/lm</p> <p>LEDs/each optic: 1</p> <p>Light colour: White</p> <p>Required components:</p>	
<p>OSRAM Opto Semiconductors</p> <p>LED: OSCONIQ P 3737 (2W version)</p> <p>FWHM / FWTM: 12.0 + 49.0° / 28.0 + 72.0°</p> <p>Efficiency: 85 %</p> <p>Peak intensity: 9.3 cd/lm</p> <p>LEDs/each optic: 1</p> <p>Light colour: White</p> <p>Required components:</p>	
<p>OSRAM Opto Semiconductors</p> <p>LED: OSCONIQ P 3737 (3W version)</p> <p>FWHM / FWTM: 16.0 + 51.0° / 34.0 + 75.0°</p> <p>Efficiency: 85 %</p> <p>Peak intensity: 6.3 cd/lm</p> <p>LEDs/each optic: 1</p> <p>Light colour: White</p> <p>Required components:</p>	
<p>OSRAM Opto Semiconductors</p> <p>LED: OSOLON Square CSSRM2/CSSRM3</p> <p>FWHM / FWTM: 12.0 + 49.0° / 28.0 + 71.0°</p> <p>Efficiency: 85 %</p> <p>Peak intensity: 9 cd/lm</p> <p>LEDs/each optic: 1</p> <p>Light colour: White</p> <p>Required components:</p>	

OPTICAL RESULTS (SIMULATED):

SAMSUNG

LED LH351C
 FWHM / FWTM 16.0 + 50.0° / 34.0 + 74.0°
 Efficiency 85 %
 Peak intensity 6.4 cd/lm
 LEDs/each optic 1
 Light colour White
 Required components:

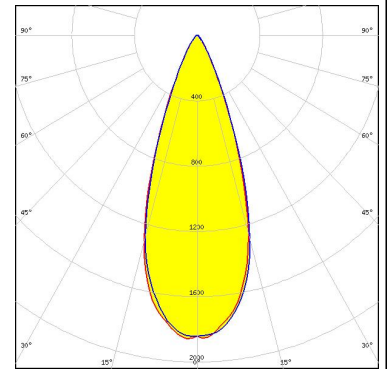

SAMSUNG

LED LH502D
 FWHM / FWTM 22.0 + 52.0° / 46.0 + 85.0°
 Efficiency 80 %
 Peak intensity 3.4 cd/lm
 LEDs/each optic 1
 Light colour White
 Required components:

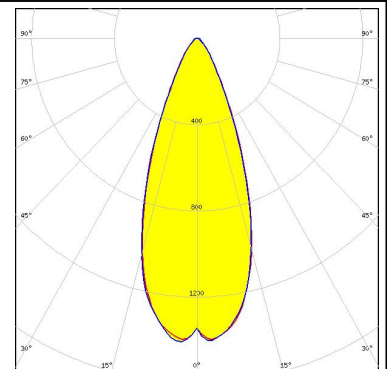

SEOUL SEMICONDUCTOR
 LED SEOUL DC 5050 6V
 FWHM / FWTM 22.0 + 54.0° / 48.0 + 86.0°
 Efficiency 80 %
 Peak intensity 3 cd/lm
 LEDs/each optic 1
 Light colour White
 Required components:

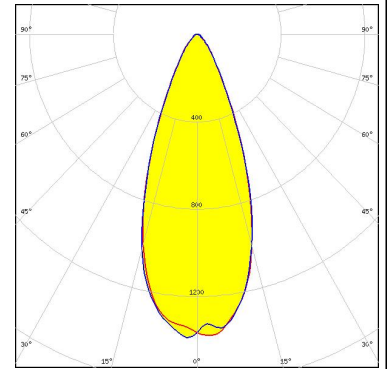

SEOUL SEMICONDUCTOR
 LED Z5M4
 FWHM / FWTM 18.0 + 50.0° / 36.0 + 76.0°
 Efficiency 83 %
 Peak intensity 5.7 cd/lm
 LEDs/each optic 1
 Light colour White
 Required components:

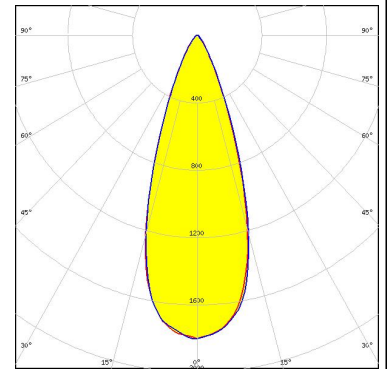

GENERAL INFORMATION:

NOTE: The typical beam angle will be changed by different color, chip size and chip position tolerance. The typical total beam angle is the full angle measured where the luminous intensity is half of the peak value.

Due to use of high power COB's with this product, special attention to proper thermal design is highly recommended. LEDiL has no liability for direct, indirect or consecutive damages arising from the LEDiL products being used outside of the recommended temperature range.

MATERIALS:

As part of our continuous research and improvement processes, and to ensure the best possible quality and availability of our products, LEDiL reserves the right to change material grades without notice.

PRODUCT DATA USER AGREEMENT AND DISCLAIMER:

The measured data in the provided downloadable LEDiL Product Datasheets and Mechanical 2D-Drawings is rounded and provided as reference for planning. LEDiL Oy's optical specifications have been verified by conducting performance testing of the products in accordance with the company's quality system. The reported data are averaged results of multiple measurements with typical variation. LEDiL Oy reserves the right to without prior notification make changes and improvements to its products.

LEDiL Oy assumes neither warranty, nor guarantee nor any other liability of any kind for the contents and correctness of the provided data. The provided data has been generated with highest diligence but the provided data may in reality not represent the complete possible variation range of all intrinsic parameters. Therefore, in certain cases a deviation from the provided data could occur.

LEDiL Oy reserves the right to undertake technical changes of its products without further notification which could lead to changes in the provided data. LEDiL Oy assumes no liability of any kind for the possible deviation from any provided data or any other damage resulting from the usage of the provided data.

The user agrees to this disclaimer and user agreement with the download or usage of the provided files.

LEDiL Oy

Joensuunkatu 13
FI-24240 SALO
Finland

LEDiL Inc.

228 West Page Street
Suite D
Sycamore IL 60178
USA

Ledil Optics Technology (Shenzhen) Co., Ltd.

405 , Block B
Casic Motor Building
Shenzhen 518057
P.R.CHINA

Local sales and technical support

[www.ledil.com/
where_to_buy](http://www.ledil.com/where_to_buy)

Shipping locations

Salo, Finland
Hong Kong, China

Distribution Partners

[www.ledil.com/
where_to_buy](http://www.ledil.com/where_to_buy)