

AMY-50-S2-C

~15° spot beam with soft cutoff. Assembly with holder C compatible with LEDiL HEKLA. Black version.

SPECIFICATION:

Dimensions	Ø 49.9 mm
Height	12.9 mm
Fastening	socket
ROHS compliant	yes ⓘ



MATERIALS:

Component	Type	Material	Colour	Finish
AMY-50-S2	Single lens	PMMA	clear	
AMY-50-HLD-C	Holder	PC	black	





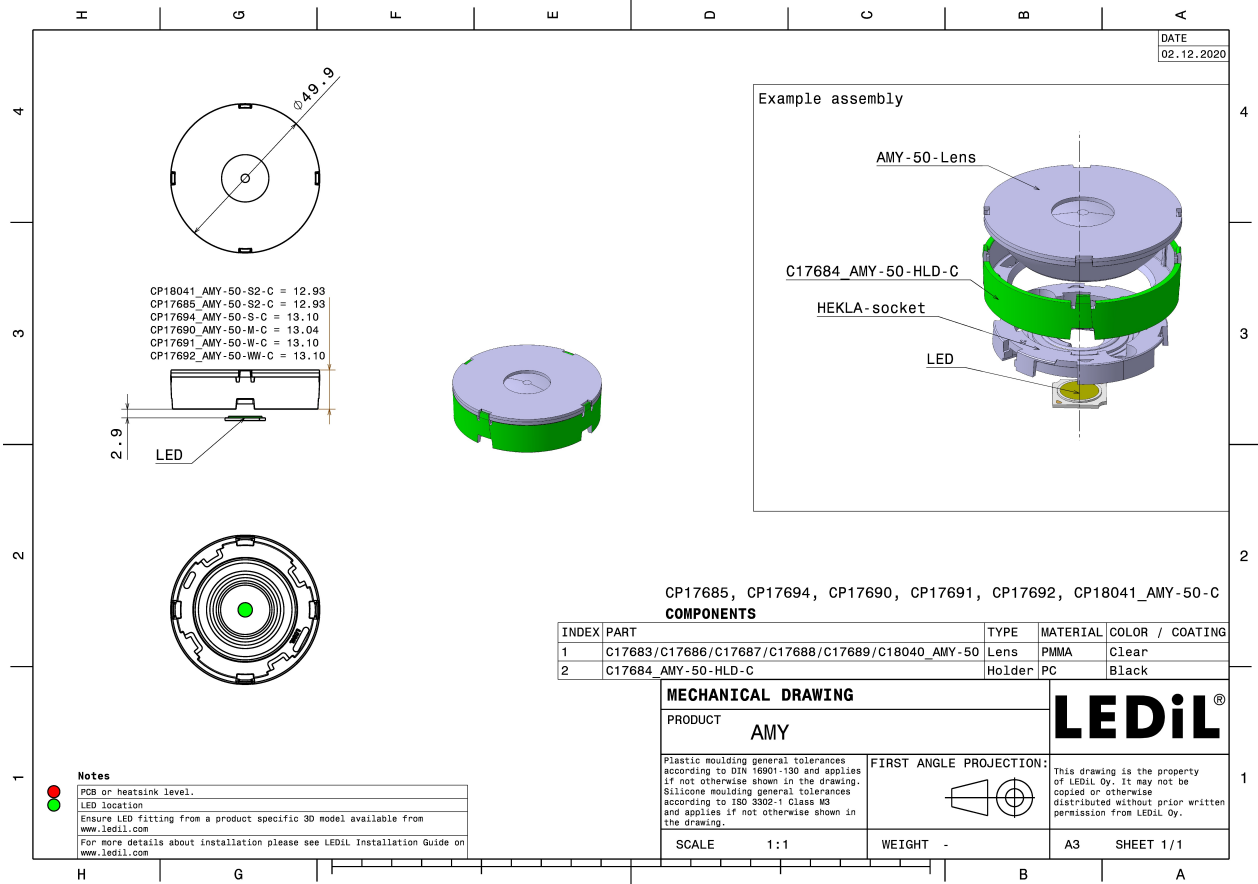



ORDERING INFORMATION:

Component	Qty in box	MOQ	MPQ	Box weight (kg)
CP18041_AMY-50-S2-C » Box size: 480 x 280 x 300 mm	510	120	30	8.8

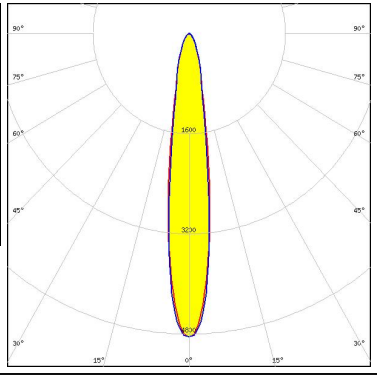

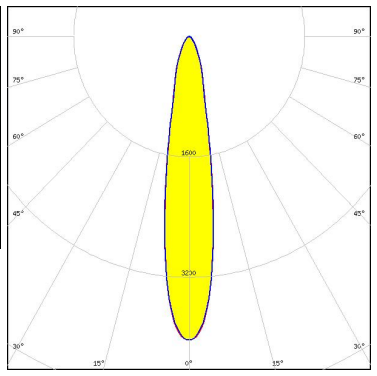

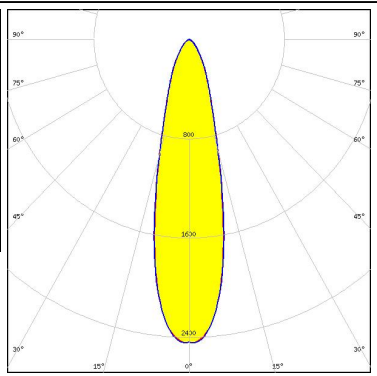

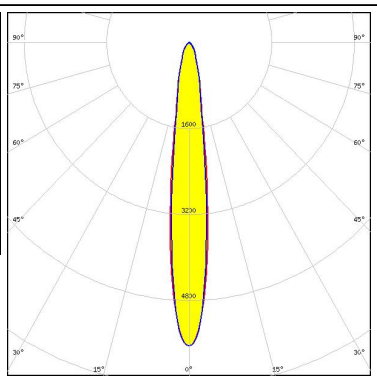



See also our general installation guide: www.ledil.com/installation_guide

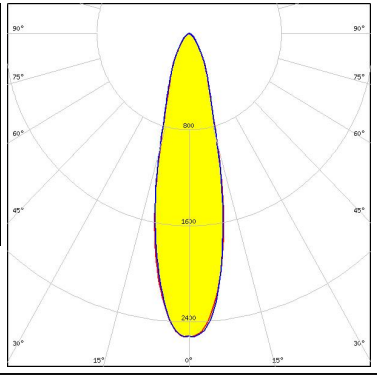

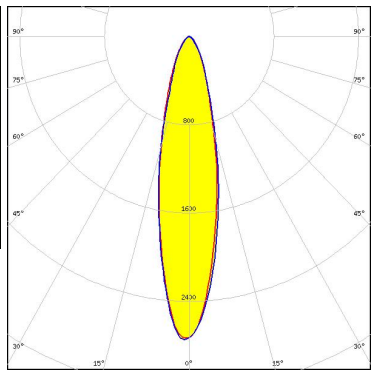

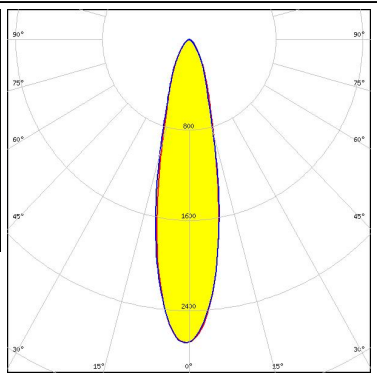

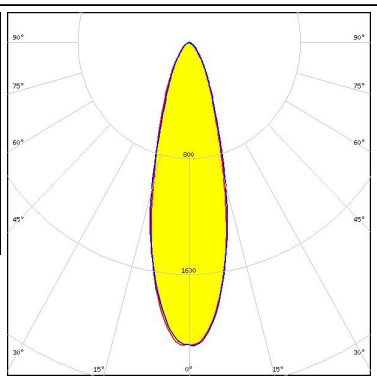

OPTICAL RESULTS (MEASURED):

<p></p> <p>LED V10 Gen 8</p> <p>FWHM / FWTM 16.0° / 42.0°</p> <p>Efficiency 90 %</p> <p>Peak intensity 4.9 cd/lm</p> <p>LEDs/each optic 1</p> <p>Light colour White</p> <p>Required components: F15255_HEKLA-SOCKET-C</p>		
<p></p> <p>LED V11 HD Gen 8</p> <p>FWHM / FWTM 19.0° / 47.0°</p> <p>Efficiency 91 %</p> <p>Peak intensity 4 cd/lm</p> <p>LEDs/each optic 1</p> <p>Light colour White</p> <p>Required components: Bender Wirth: 633d Hekla</p>		
<p></p> <p>LED V13 Gen 8</p> <p>FWHM / FWTM 26.0° / 61.0°</p> <p>Efficiency 89 %</p> <p>Peak intensity 2.5 cd/lm</p> <p>LEDs/each optic 1</p> <p>Light colour White</p> <p>Required components: F15859_HEKLA-SOCKET-I</p>		
<p></p> <p>LED V8 Gen 8</p> <p>FWHM / FWTM 14.0° / 37.0°</p> <p>Efficiency 91 %</p> <p>Peak intensity 5.7 cd/lm</p> <p>LEDs/each optic 1</p> <p>Light colour White</p> <p>Required components: F15253_HEKLA-SOCKET-A</p>		

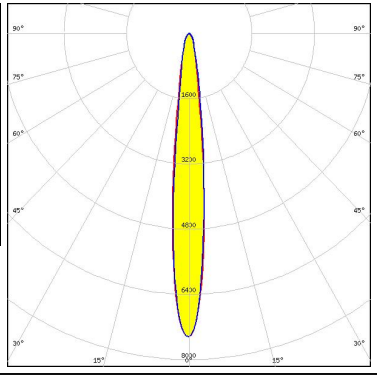
OPTICAL RESULTS (MEASURED):

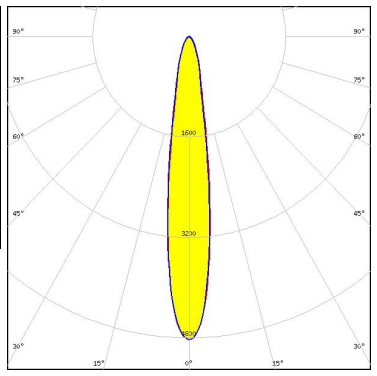
<p></p> <p>LED Vesta DTW 13mm (21W) FWHM / FWTM 26.0° / 60.0° Efficiency 87 % Peak intensity 2.5 cd/m LEDs/each optic 1 Light colour White</p> <p>Required components: C16142_HEKLA-SOCKET-K Bender Wirth: 491 Typ L8</p>		
<p></p> <p>LED Vesta DTW 15mm (33W) FWHM / FWTM 23.0° / 57.0° Efficiency 87 % Peak intensity 2.8 cd/m LEDs/each optic 1 Light colour White</p> <p>Required components: C16142_HEKLA-SOCKET-K Bender Wirth: 491 Typ L8</p>		
<p></p> <p>LED Vesta TW 13mm (18W) DP FWHM / FWTM 24.0° / 58.0° Efficiency 87 % Peak intensity 2.7 cd/m LEDs/each optic 1 Light colour Tunable White</p> <p>Required components: C16142_HEKLA-SOCKET-K Bender Wirth: 492 Typ L8</p>		
<p></p> <p>LED Vesta TW 15mm DP FWHM / FWTM 29.0° / 65.0° Efficiency 87 % Peak intensity 2.1 cd/m LEDs/each optic 1 Light colour Tunable White</p> <p>Required components: C16142_HEKLA-SOCKET-K Bender Wirth: 482 Typ L8</p>		

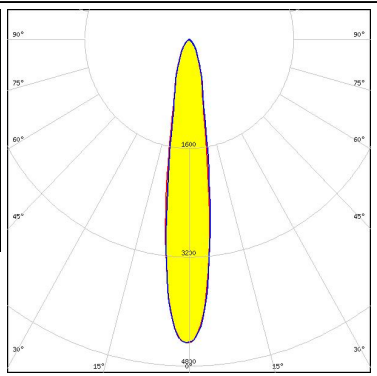

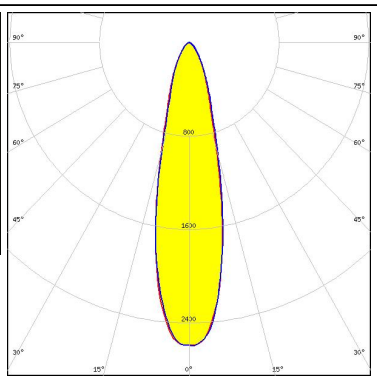

OPTICAL RESULTS (MEASURED):

<p></p> <p>LED Vesta TW 6mm DP FWHM / FWTM 12.0° / 29.0° Efficiency 88 % Peak intensity 7.4 cd/lm LEDs/each optic 1 Light colour Tunable White Required components: C16142_HEKLA-SOCKET-K Bender Wirth: 504 Typ L8</p>		
<p></p> <p>LED Vesta TW 9mm (9W) DP FWHM / FWTM 16.0° / 41.0° Efficiency 88 % Peak intensity 4.8 cd/lm LEDs/each optic 1 Light colour Tunable White Required components: C16142_HEKLA-SOCKET-K Bender Wirth: 489 Typ L8</p>		
<p>CITIZEN</p> <p>LED CLL02x/CLU02x (LES10) FWHM / FWTM 17.0° / 45.0° Efficiency 91 % Peak intensity 4.5 cd/lm LEDs/each optic 1 Light colour White Required components: F17435_HEKLA-G2-C</p>		
<p></p> <p>LED CTM-14 (Tunable White) Gen2 FWHM / FWTM 25.0° / 58.0° Efficiency 88 % Peak intensity 2.6 cd/lm LEDs/each optic 1 Light colour Tunable White Required components: C16142_HEKLA-SOCKET-K Bender Wirth: 442 Typ L8</p>		

OPTICAL RESULTS (SIMULATED):

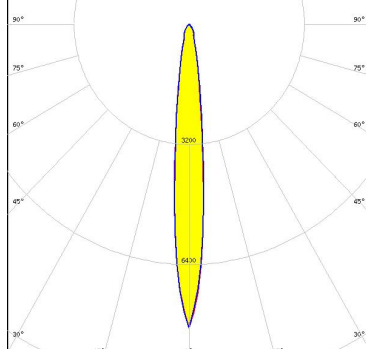
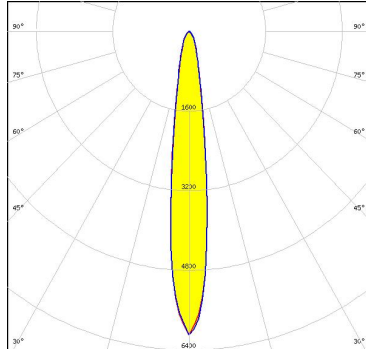
<p>bridgelux.</p> <p>LED V6 HD Gen 8</p> <p>FWHM / FWTM 11.0 + 10.0° / 28.0°</p> <p>Efficiency 93 %</p> <p>Peak intensity 8.8 cd/lm</p> <p>LEDs/each optic 1</p> <p>Light colour White</p> <p>Required components: F15255_HEKLA-SOCKET-C</p>	
<p>bridgelux.</p> <p>LED V8 Gen7</p> <p>FWHM / FWTM 13.0° / 34.0°</p> <p>Efficiency 90 %</p> <p>Peak intensity 6.6 cd/lm</p> <p>LEDs/each optic 1</p> <p>Light colour White</p> <p>Required components: F15253_HEKLA-SOCKET-A</p>	
<p>bridgelux.</p> <p>LED VERO10</p> <p>FWHM / FWTM 14.0° / 37.0°</p> <p>Efficiency 91 %</p> <p>Peak intensity 5.9 cd/lm</p> <p>LEDs/each optic 1</p> <p>Light colour White</p> <p>Required components: F15616_HEKLA-SOCKET-F</p>	
<p>bridgelux.</p> <p>LED VERO13</p> <p>FWHM / FWTM 22.0° / 56.0°</p> <p>Efficiency 92 %</p> <p>Peak intensity 3.2 cd/lm</p> <p>LEDs/each optic 1</p> <p>Light colour White</p> <p>Required components: C16142_HEKLA-SOCKET-K</p>	

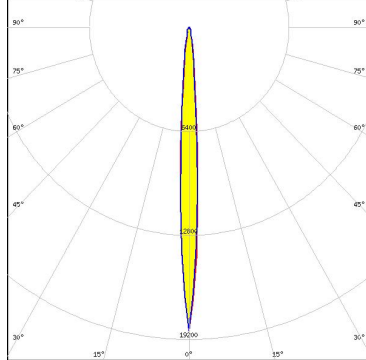

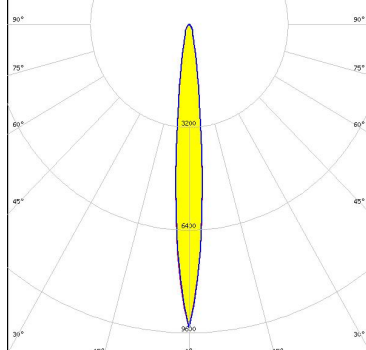
OPTICAL RESULTS (SIMULATED):

<p> LED Vesta DTW 6mm</p> <p>FWHM / FWTM 12.0° / 30.0°</p> <p>Efficiency 93 %</p> <p>Peak intensity 8.1 cd/lm</p> <p>LEDs/each optic 1</p> <p>Light colour White</p> <p>Required components: Bender Wirth: 652b Hekla</p>	
<p>CITIZEN</p> <p>LED CLU712/713</p> <p>FWHM / FWTM 14.0° / 34.0°</p> <p>Efficiency 90 %</p> <p>Peak intensity 6.1 cd/lm</p> <p>LEDs/each optic 1</p> <p>Light colour White</p> <p>Required components: F17438_HEKLA-G2-I</p>	
<p> LED CHA0304</p> <p>FWHM / FWTM 6.0° / 18.0°</p> <p>Efficiency 90 %</p> <p>Peak intensity 18.7 cd/lm</p> <p>LEDs/each optic 1</p> <p>Light colour White</p> <p>Required components: F17435_HEKLA-G2-C</p>	
<p> LED CHA0612</p> <p>FWHM / FWTM 10.0° / 26.0°</p> <p>Efficiency 90 %</p> <p>Peak intensity 9.4 cd/lm</p> <p>LEDs/each optic 1</p> <p>Light colour White</p> <p>Required components: F17435_HEKLA-G2-C</p>	

OPTICAL RESULTS (SIMULATED):

<p>CREE LED</p> <p>LED: CHA0825 FWHM / FWTM: 14.0° / 37.0° Efficiency: 90 % Peak intensity: 5.7 cd/lm LEDs/each optic: 1 Light colour: White Required components: F17438_HEKLA-G2-I</p>	
<p>LUMILEDS</p> <p>LED: LUXEON CoB 1204HD FWHM / FWTM: 15.0° / 40.0 + 38.0° Efficiency: 93 % Peak intensity: 5.5 cd/lm LEDs/each optic: 1 Light colour: White Required components: F15858_HEKLA-SOCKET-H</p>	
<p>LUMILEDS</p> <p>LED: LUXEON CoB 1205HD FWHM / FWTM: 20.0° / 48.0° Efficiency: 92 % Peak intensity: 4 cd/lm LEDs/each optic: 1 Light colour: White Required components: F15858_HEKLA-SOCKET-H</p>	
<p>NICHIA</p> <p>LED: COB S-Type (LES 7) FWHM / FWTM: 12.0° / 28.0° Efficiency: 89 % Peak intensity: 8.3 cd/lm LEDs/each optic: 1 Light colour: White Required components: Bender Wirth: 652a Hekla</p>	

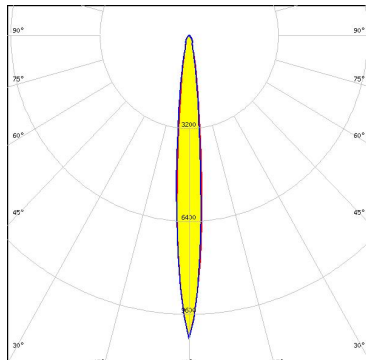
OPTICAL RESULTS (SIMULATED):

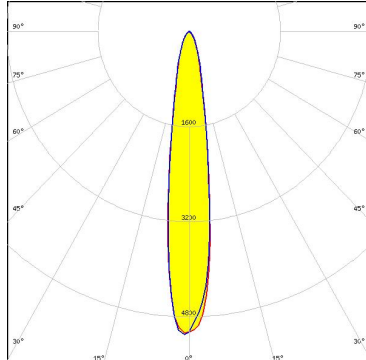
<p> SEUL SEMICONDUCTOR</p> <p>LED MJT COB LES 6</p> <p>FWHM / FWTM 10.0° / 24.0°</p> <p>Efficiency 91 %</p> <p>Peak intensity 10.4 cd/lm</p> <p>LEDs/each optic 1</p> <p>Light colour White</p> <p>Required components: F17435_HEKLA-G2-C</p>	
<p> SEUL SEMICONDUCTOR</p> <p>LED MJT COB LES 9.8</p> <p>FWHM / FWTM 16.0° / 40.0°</p> <p>Efficiency 91 %</p> <p>Peak intensity 5.1 cd/lm</p> <p>LEDs/each optic 1</p> <p>Light colour White</p> <p>Required components: F17435_HEKLA-G2-C</p>	

GENERAL INFORMATION:

NOTE: The typical beam angle will be changed by different color, chip size and chip position tolerance. The typical total beam angle is the full angle measured where the luminous intensity is half of the peak value.

Due to use of high power COB's with this product, special attention to proper thermal design is highly recommended. LEDiL has no liability for direct, indirect or consecutive damages arising from the LEDiL products being used outside of the recommended temperature range.

MATERIALS:

As part of our continuous research and improvement processes, and to ensure the best possible quality and availability of our products, LEDiL reserves the right to change material grades without notice.

PRODUCT DATA USER AGREEMENT AND DISCLAIMER:

The measured data in the provided downloadable LEDiL Product Datasheets and Mechanical 2D-Drawings is rounded and provided as reference for planning. LEDiL Oy's optical specifications have been verified by conducting performance testing of the products in accordance with the company's quality system. The reported data are averaged results of multiple measurements with typical variation. LEDiL Oy reserves the right to without prior notification make changes and improvements to its products.

LEDiL Oy assumes neither warranty, nor guarantee nor any other liability of any kind for the contents and correctness of the provided data. The provided data has been generated with highest diligence but the provided data may in reality not represent the complete possible variation range of all intrinsic parameters. Therefore, in certain cases a deviation from the provided data could occur.

LEDiL Oy reserves the right to undertake technical changes of its products without further notification which could lead to changes in the provided data. LEDiL Oy assumes no liability of any kind for the possible deviation from any provided data or any other damage resulting from the usage of the provided data.

The user agrees to this disclaimer and user agreement with the download or usage of the provided files.

LEDiL Oy

Joensuunkatu 13
FI-24240 SALO
Finland

LEDiL Inc.

228 West Page Street
Suite D
Sycamore IL 60178
USA

Ledil Optics Technology (Shenzhen) Co., Ltd.

405 , Block B
Casic Motor Building
Shenzhen 518057
P.R.CHINA

Local sales and technical support

[www.ledil.com/
where_to_buy](http://www.ledil.com/where_to_buy)

Shipping locations

Salo, Finland
Hong Kong, China

Distribution Partners

[www.ledil.com/
where_to_buy](http://www.ledil.com/where_to_buy)