

AMY-70-WW-C

~60° wide beam. Assembly with holder C compatible with LEDiL HEKLA. Black version.

SPECIFICATION:

Dimensions	Ø 69.9 mm
Height	16.4 mm
ROHS compliant	yes ⓘ



MATERIALS:

Component	Type	Material	Colour	Finish
AMY-70-WW	Single lens	PMMA		
AMY-70-HLD-C	Holder	PC	black	





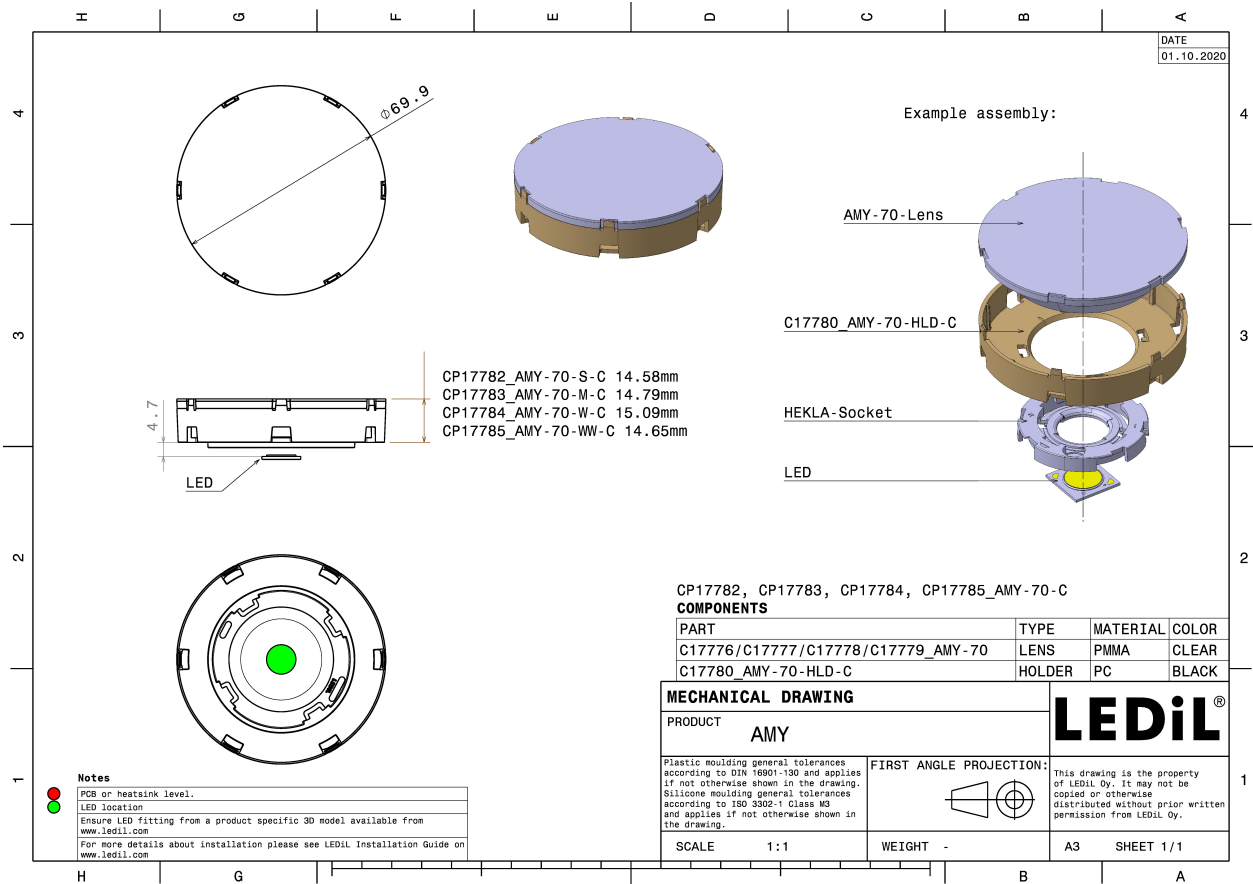



ORDERING INFORMATION:

Component	Qty in box	MOQ	MPQ	Box weight (kg)
CP17785_AMY-70-WW-C » Box size: 480 x 280 x 300 mm	210	210	15	7.4

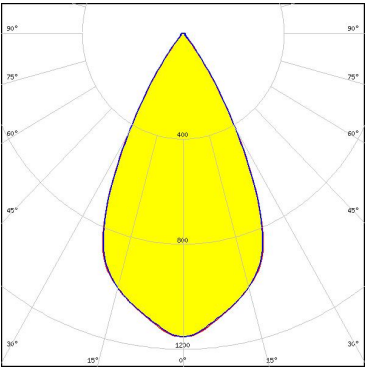

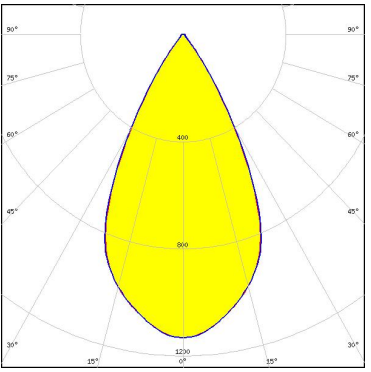
See also our general installation guide: www.ledil.com/installation_guide

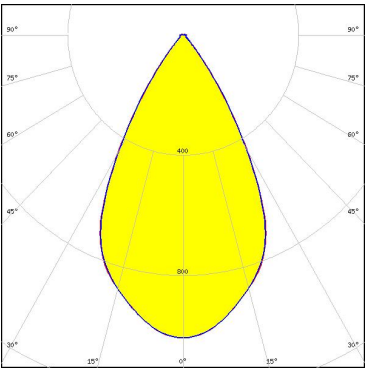
OPTICAL RESULTS (MEASURED):

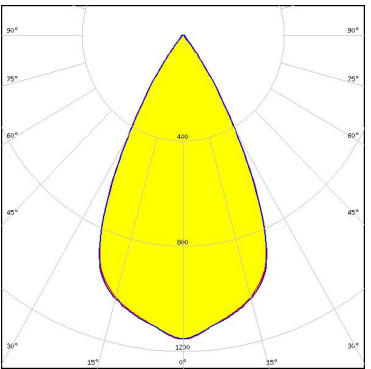
<p></p> <p>LED V10 Gen 8 FWHM / FWTM 55.0° / 75.0° Efficiency 89 % Peak intensity 1.2 cd/lm LEDs/each optic 1 Light colour White Required components: F15255_HEKLA-SOCKET-C</p>		
<p></p> <p>LED V11 HD Gen 8 FWHM / FWTM 54.0° / 76.0° Efficiency 87 % Peak intensity 1.1 cd/lm LEDs/each optic 1 Light colour White Required components: Bender Wirth: 633d Hekla</p>		
<p></p> <p>LED V13 Gen 8 FWHM / FWTM 58.0° / 80.0° Efficiency 87 % Peak intensity 1 cd/lm LEDs/each optic 1 Light colour White Required components: F15859_HEKLA-SOCKET-I</p>		
<p></p> <p>LED V8 Gen 8 FWHM / FWTM 55.0° / 75.0° Efficiency 90 % Peak intensity 1.2 cd/lm LEDs/each optic 1 Light colour White Required components: F15253_HEKLA-SOCKET-A</p>		

OPTICAL RESULTS (MEASURED):

CITIZEN

LED CLL02x/CLU02x (LES10)
 FWHM / FWTM 54.0° / 75.0°
 Efficiency 87 %
 Peak intensity 1.2 cd/lm
 LEDs/each optic 1
 Light colour White
 Required components:
 F17435_HEKLA-G2-C

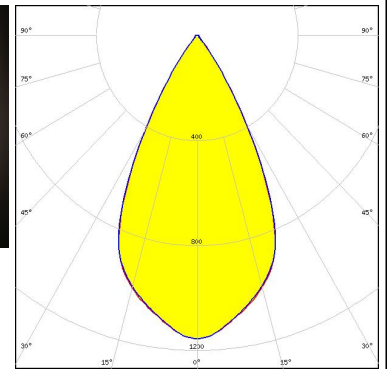
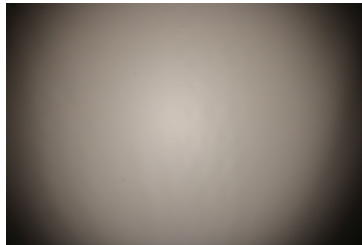

CREE LED

LED CMU15xx
 FWHM / FWTM 57.0° / 80.0°
 Efficiency 85 %
 Peak intensity 1 cd/lm
 LEDs/each optic 1
 Light colour White
 Required components:
 F17438_HEKLA-G2-I

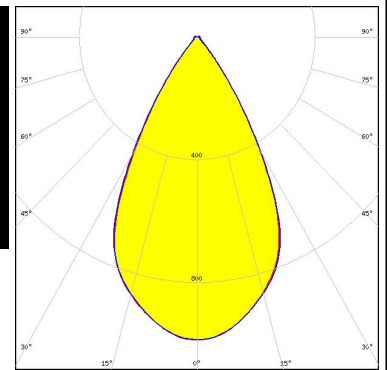
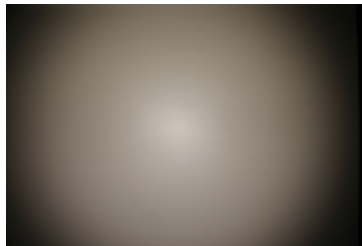

LUMILEDS

LED LUXEON Fusion 12-up (20x24)
 FWHM / FWTM 53.0° / 76.0°
 Efficiency 86 %
 Peak intensity 1.1 cd/lm
 LEDs/each optic 12
 Light colour White
 Required components:
 C16142_HEKLA-SOCKET-K
 F18158_HEKLA-RZ-LENS
 Bender Wirth: 442 Typ L8

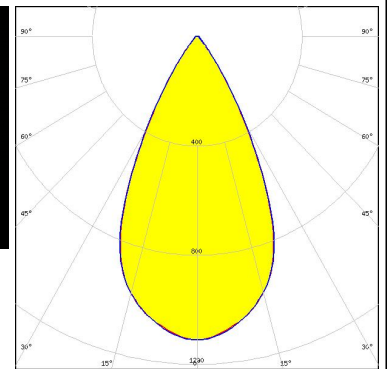

LUMILEDS

LED LUXEON Fusion 21-up (20x24)
 FWHM / FWTM 53.0° / 76.0°
 Efficiency 80 %
 Peak intensity 1 cd/lm
 LEDs/each optic 21
 Light colour White
 Required components:
 C16142_HEKLA-SOCKET-K
 F18158_HEKLA-RZ-LENS
 Bender Wirth: 442 Typ L8

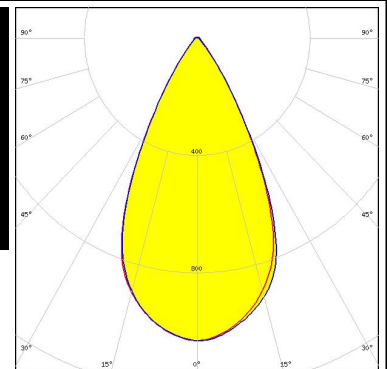
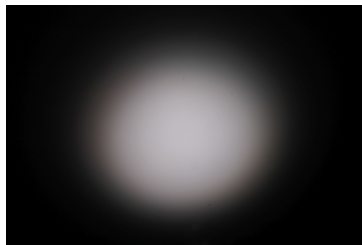

OPTICAL RESULTS (MEASURED):

LUMILEDS

LED LUXEON Fusion 27-up (20x24)
 FWHM / FWTM 54.0° / 78.0°
 Efficiency 80 %
 Peak intensity 1 cd/lm
 LEDs/each optic 27
 Light colour White

Required components:

C16142_HEKLA-SOCKET-K
 F18158_HEKLA-RZ-LENS
 Bender Wirth: 442 Typ L8

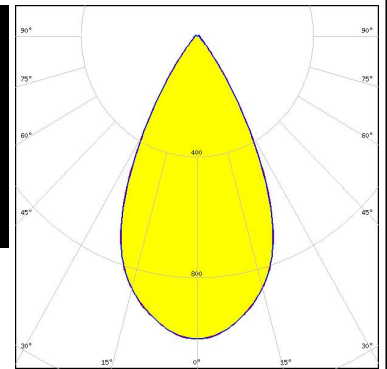

LUMINUS

LED CTM-14 (Tunable White) Gen2
 FWHM / FWTM 56.0° / 78.0°
 Efficiency 86 %
 Peak intensity 1 cd/lm
 LEDs/each optic 1
 Light colour Tunable White

Required components:

C16142_HEKLA-SOCKET-K
 Bender Wirth: 442 Typ L8

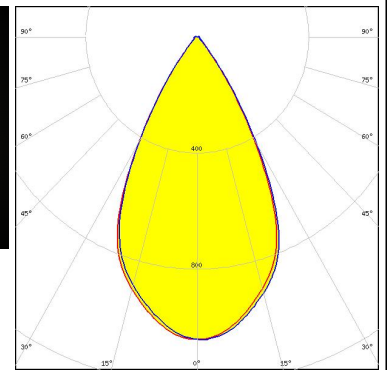
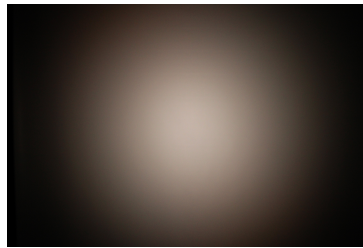

SAMSUNG





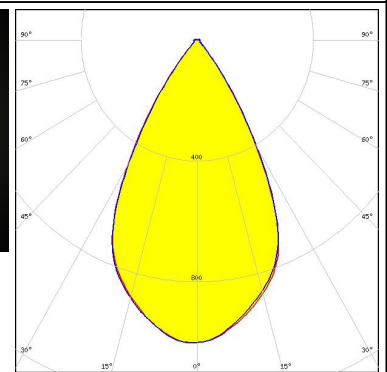
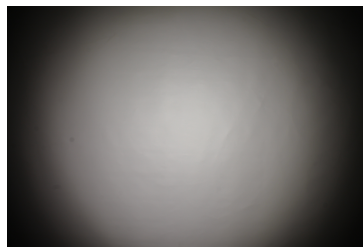

LED LC016D / LC019D / LC026D / LC033D
 FWHM / FWTM 58.0° / 79.0°
 Efficiency 87 %
 Peak intensity 1 cd/lm
 LEDs/each optic 1
 Light colour White

Required components:

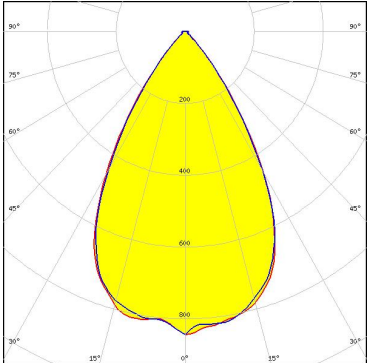

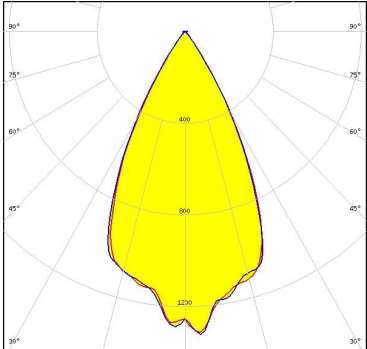

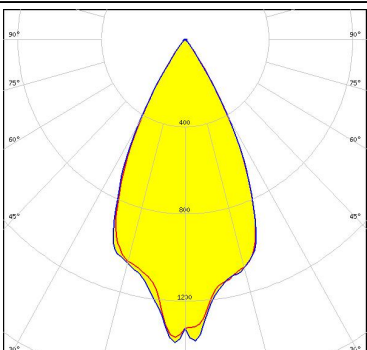

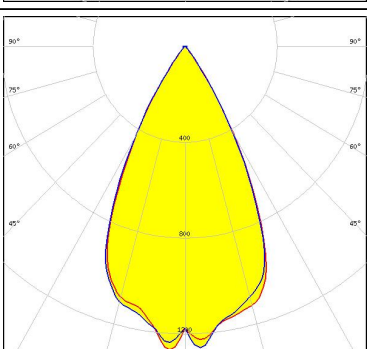
F15859_HEKLA-SOCKET-I

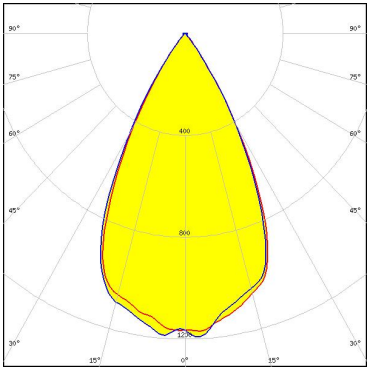

OPTICAL RESULTS (SIMULATED):

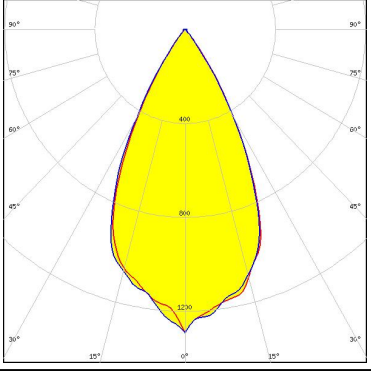
<p></p> <p>LED V18 Gen 8</p> <p>FWHM / FWTM 62.0° / 86.0°</p> <p>Efficiency 83 %</p> <p>Peak intensity 0.8 cd/lm</p> <p>LEDs/each optic 1</p> <p>Light colour White</p> <p>Required components: Bender Wirth: 639b Hekla XL</p>	
<p></p> <p>LED V3 HD Gen 8</p> <p>FWHM / FWTM 52.0° / 72.0°</p> <p>Efficiency 91 %</p> <p>Peak intensity 1.3 cd/lm</p> <p>LEDs/each optic 1</p> <p>Light colour White</p> <p>Required components: F15253_HEKLA-SOCKET-A</p>	
<p></p> <p>LED V3 HD Gen 8 FC</p> <p>FWHM / FWTM 52.0° / 72.0° + 71.0°</p> <p>Efficiency 90 %</p> <p>Peak intensity 1.4 cd/lm</p> <p>LEDs/each optic 1</p> <p>Light colour White</p> <p>Required components: F15255_HEKLA-SOCKET-C</p>	
<p></p> <p>LED V4 HD Gen 8</p> <p>FWHM / FWTM 53.0 + 54.0° / 72.0°</p> <p>Efficiency 91 %</p> <p>Peak intensity 1.3 cd/lm</p> <p>LEDs/each optic 1</p> <p>Light colour White</p> <p>Required components: F15253_HEKLA-SOCKET-A</p>	

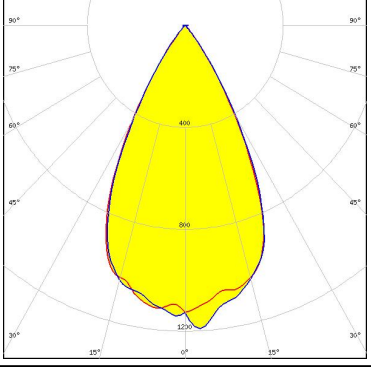

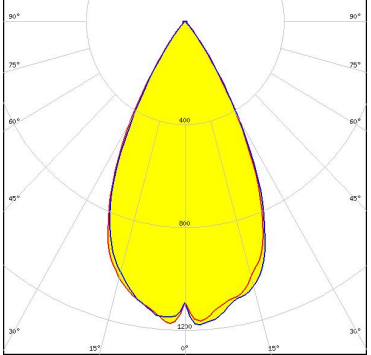



OPTICAL RESULTS (SIMULATED):

<p></p> <p>LED V6 Gen 8 FWHM / FWTM 55.0° / 74.0° Efficiency 90 % Peak intensity 1.2 cd/lm LEDs/each optic 1 Light colour White Required components: F15253_HEKLA-SOCKET-A</p>	
<p></p> <p>LED V6 HD Gen 8 FWHM / FWTM 52.0° / 73.0 + 72.0° Efficiency 90 % Peak intensity 1.3 cd/lm LEDs/each optic 1 Light colour White Required components: F15255_HEKLA-SOCKET-C</p>	
<p></p> <p>LED V8 Gen7 FWHM / FWTM 55.0° / 74.0° Efficiency 87 % Peak intensity 1.2 cd/lm LEDs/each optic 1 Light colour White Required components: F15253_HEKLA-SOCKET-A</p>	
<p></p> <p>LED V9 HD Gen 8 FWHM / FWTM 54.0° / 74.0° Efficiency 89 % Peak intensity 1.2 cd/lm LEDs/each optic 1 Light colour White Required components: F15859_HEKLA-SOCKET-I</p>	

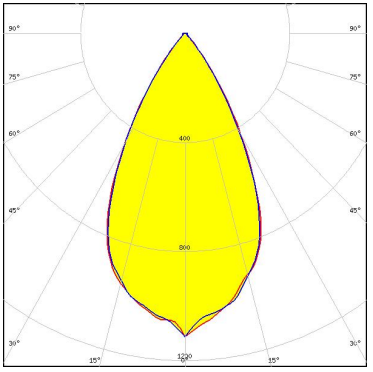
OPTICAL RESULTS (SIMULATED):

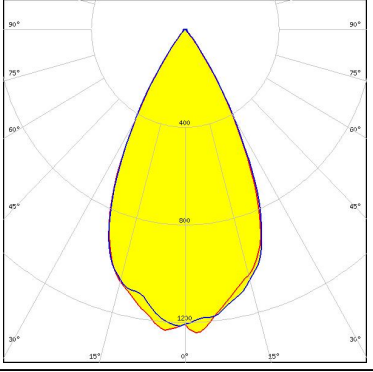
<p>bridgelux.</p> <p>LED VERO10</p> <p>FWHM / FWTM 54.0° / 74.0°</p> <p>Efficiency 87 %</p> <p>Peak intensity 1.2 cd/lm</p> <p>LEDs/each optic 1</p> <p>Light colour White</p> <p>Required components: F15616_HEKLA-SOCKET-F</p>	
<p>bridgelux.</p> <p>LED VERO13</p> <p>FWHM / FWTM 56.0° / 76.0°</p> <p>Efficiency 85 %</p> <p>Peak intensity 1.1 cd/lm</p> <p>LEDs/each optic 1</p> <p>Light colour White</p> <p>Required components: C16142_HEKLA-SOCKET-K</p>	
<p>bridgelux.</p> <p>LED VERO18</p> <p>FWHM / FWTM 62.0° / 88.0°</p> <p>Efficiency 87 %</p> <p>Peak intensity 0.9 cd/lm</p> <p>LEDs/each optic 1</p> <p>Light colour White</p> <p>Required components: C16142_HEKLA-SOCKET-K</p>	
<p>bridgelux.</p> <p>LED Vesta DTW 13mm (21W)</p> <p>FWHM / FWTM 53.0° / 74.0°</p> <p>Efficiency 89 %</p> <p>Peak intensity 1.3 cd/lm</p> <p>LEDs/each optic 1</p> <p>Light colour White</p> <p>Required components: Bender Wirth: 632b Hekla XL</p>	

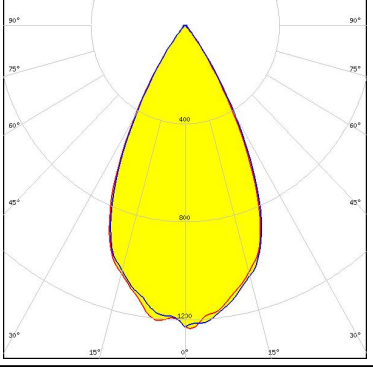
OPTICAL RESULTS (SIMULATED):

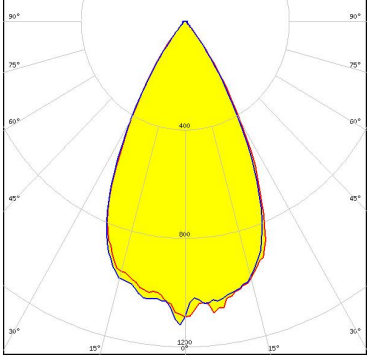
<p></p> <p>LED Vesta DTW 15mm (33W) FWHM / FWTM 55.0 + 54.0° / 79.0° Efficiency 87 % Peak intensity 1.1 cd/lm LEDs/each optic 1 Light colour White Required components: Bender Wirth: 632b Hekla XL</p>	
<p></p> <p>LED Vesta DTW 6mm FWHM / FWTM 53.0 + 54.0° / 73.0 + 74.0° Efficiency 89 % Peak intensity 1.2 cd/lm LEDs/each optic 1 Light colour White Required components: Bender Wirth: 652b Hekla</p>	
<p></p> <p>LED Vesta DTW 9mm (4W/6W/12W) FWHM / FWTM 53.0° / 74.0° Efficiency 89 % Peak intensity 1.2 cd/lm LEDs/each optic 1 Light colour White Required components: Bender Wirth: 652b Hekla</p>	
<p></p> <p>LED Vesta TW 13mm (18W) DP FWHM / FWTM 55.0 + 54.0° / 78.0 + 76.0° Efficiency 87 % Peak intensity 1.1 cd/lm LEDs/each optic 1 Light colour Tunable White Required components: C16142_HEKLA-SOCKET-K Bender Wirth: 492 Typ L8</p>	

OPTICAL RESULTS (SIMULATED):

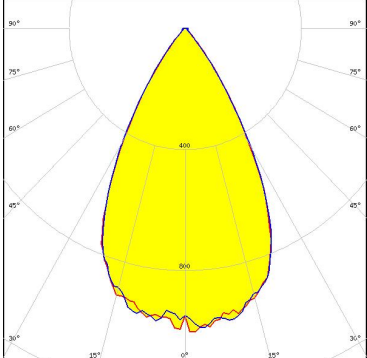
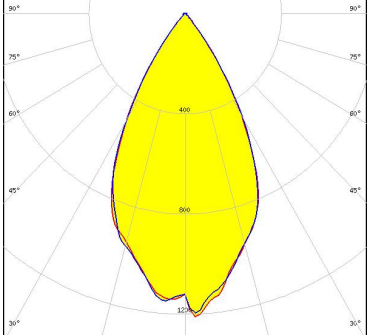
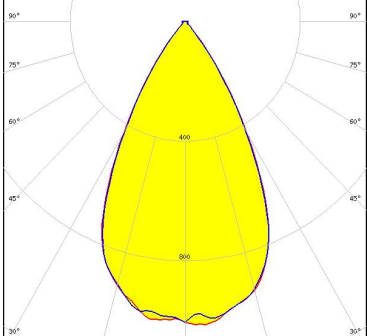
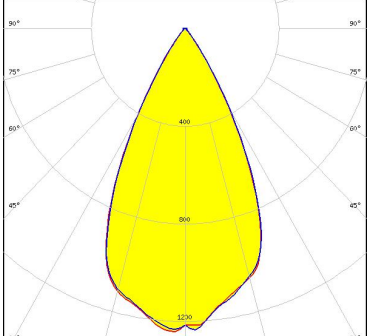
<p>bridgelux.</p> <p>LED Vesta TW 15mm DP</p> <p>FWHM / FWTM 57.0° / 79.0 + 80.0°</p> <p>Efficiency 86 %</p> <p>Peak intensity 1 cd/lm</p> <p>LEDs/each optic 1</p> <p>Light colour Tunable White</p> <p>Required components: C16142_HEKLA-SOCKET-K Bender Wirth: 482 Typ L8</p>	
<p>bridgelux.</p> <p>LED Vesta TW 9mm (9W) DP</p> <p>FWHM / FWTM 54.0° / 78.0°</p> <p>Efficiency 90 %</p> <p>Peak intensity 1.2 cd/lm</p> <p>LEDs/each optic 1</p> <p>Light colour Tunable White</p> <p>Required components: C16142_HEKLA-SOCKET-K Bender Wirth: 489 Typ L8</p>	
<p>CITIZEN</p> <p>LED CLL03x/CLU03x</p> <p>FWHM / FWTM 56.0° / 78.0°</p> <p>Efficiency 85 %</p> <p>Peak intensity 1 cd/lm</p> <p>LEDs/each optic 1</p> <p>Light colour White</p> <p>Required components: F15859_HEKLA-SOCKET-I</p>	
<p>CITIZEN</p> <p>LED CLU700/701/702/703</p> <p>FWHM / FWTM 52.0° / 72.0°</p> <p>Efficiency 88 %</p> <p>Peak intensity 1.3 cd/lm</p> <p>LEDs/each optic 1</p> <p>Light colour White</p> <p>Required components: F15255_HEKLA-SOCKET-C</p>	

OPTICAL RESULTS (SIMULATED):

CITIZEN

LED CLU700/701/702/703
 FWHM / FWTM 52.0° / 72.0°
 Efficiency 89 %
 Peak intensity 1.3 cd/lm
 LEDs/each optic 1
 Light colour White
 Required components:
 F15255_HEKLA-SOCKET-C

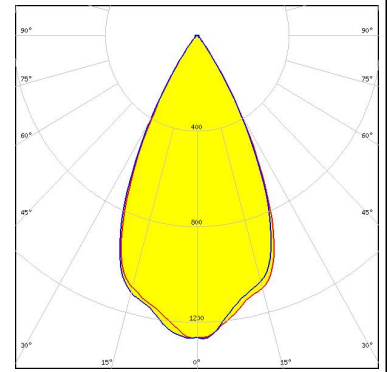

CREE LED

LED CMA1825
 FWHM / FWTM 56.0° / 78.0°
 Efficiency 86 %
 Peak intensity 1.1 cd/lm
 LEDs/each optic 1
 Light colour White
 Required components:
 F15254_HEKLA-SOCKET-B

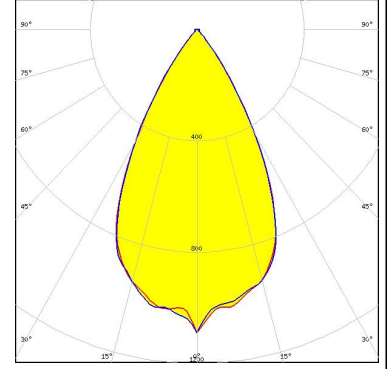

CREE LED

LED CMT14xx
 FWHM / FWTM 54.0° / 75.0°
 Efficiency 86 %
 Peak intensity 1.2 cd/lm
 LEDs/each optic 1
 Light colour White
 Required components:
 F17435_HEKLA-G2-C

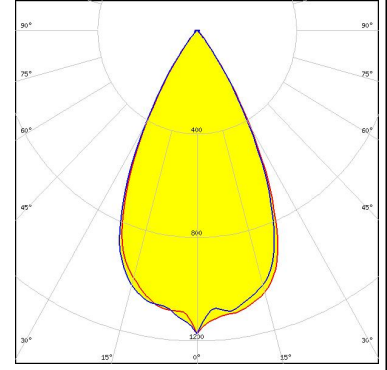

CREE LED

LED CMU10xx
 FWHM / FWTM 55.0° / 76.0°
 Efficiency 87 %
 Peak intensity 1.1 cd/lm
 LEDs/each optic 1
 Light colour White
 Required components:
 F17435_HEKLA-G2-C

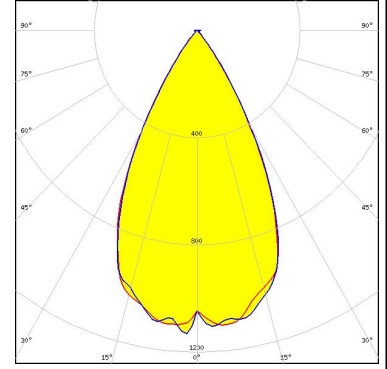

OPTICAL RESULTS (SIMULATED):



LED CXA/B 15xx
 FWHM / FWTM 55.0 + 54.0° / 74.0°
 Efficiency 86 %
 Peak intensity 1.1 cd/lm
 LEDs/each optic 1
 Light colour White
 Required components:
 F15256_HEKLA-SOCKET-D

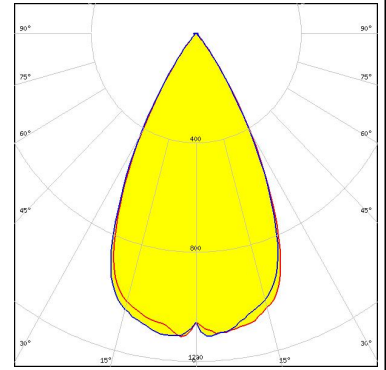

LED CXA/B 1830
 FWHM / FWTM 56.0° / 79.0°
 Efficiency 86 %
 Peak intensity 1.1 cd/lm
 LEDs/each optic 1
 Light colour White
 Required components:
 Bender Wirth: 637b Hekla

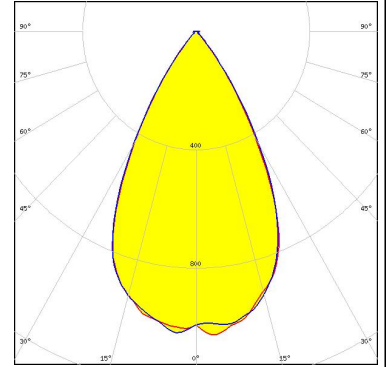

LED LUXEON CoB 1202/1203
 FWHM / FWTM 54.0° / 74.0 + 76.0°
 Efficiency 89 %
 Peak intensity 1.2 cd/lm
 LEDs/each optic 1
 Light colour White
 Required components:
 F15858_HEKLA-SOCKET-H

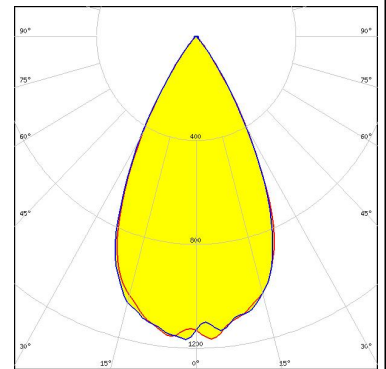

LED LUXEON CoB 1202HD
 FWHM / FWTM 54.0° / 74.0°
 Efficiency 90 %
 Peak intensity 1.2 cd/lm
 LEDs/each optic 1
 Light colour White
 Required components:
 F15848_HEKLA-SOCKET-G

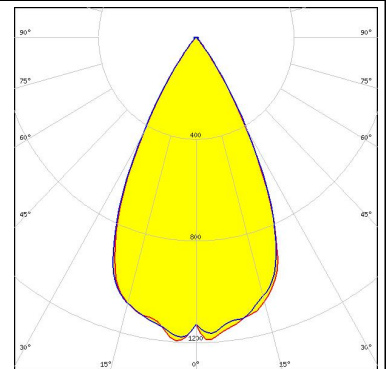

OPTICAL RESULTS (SIMULATED):

LUMILEDS

LED LUXEON CoB 1204/1205
 FWHM / FWTM 55.0 + 56.0° / 77.0 + 78.0°
 Efficiency 88 %
 Peak intensity 1.1 cd/lm
 LEDs/each optic 1
 Light colour White
 Required components:
 Bender Wirth: 632a Hekla XL

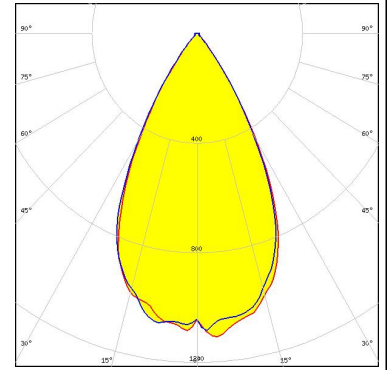

LUMILEDS

LED LUXEON CoB 1204HD
 FWHM / FWTM 54.0° / 74.0 + 76.0°
 Efficiency 89 %
 Peak intensity 1.2 cd/lm
 LEDs/each optic 1
 Light colour White
 Required components:
 F15858_HEKLA-SOCKET-H

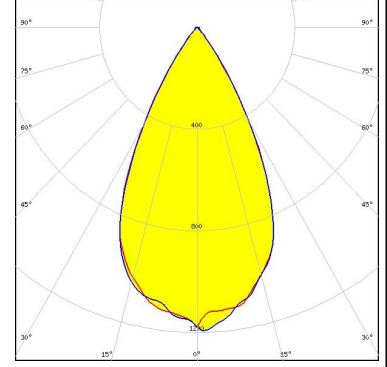

LUMILEDS

LED LUXEON CoB 1205HD
 FWHM / FWTM 56.0° / 76.0°
 Efficiency 88 %
 Peak intensity 1.1 cd/lm
 LEDs/each optic 1
 Light colour White
 Required components:
 F15858_HEKLA-SOCKET-H

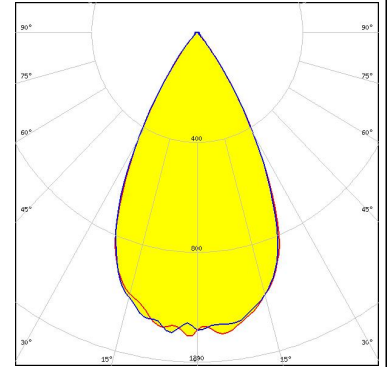

LUMILEDS

LED LUXEON CoB 1208
 FWHM / FWTM 56.0° / 78.0 + 79.0°
 Efficiency 88 %
 Peak intensity 1.1 cd/lm
 LEDs/each optic 1
 Light colour White
 Required components:
 Bender Wirth: 632a Hekla XL

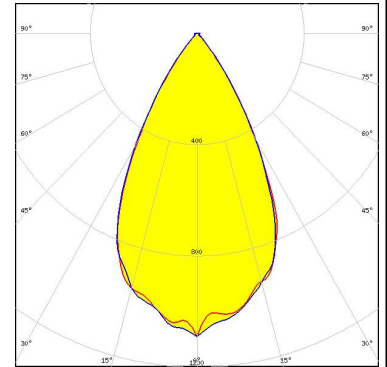

OPTICAL RESULTS (SIMULATED):

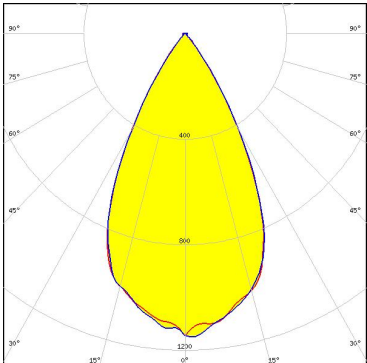
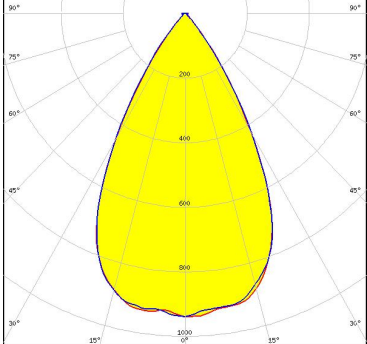
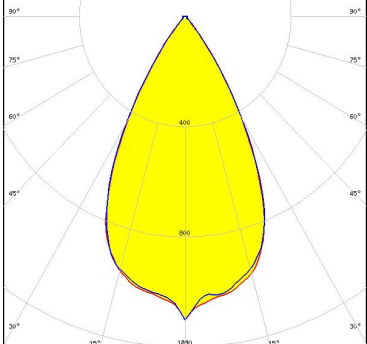
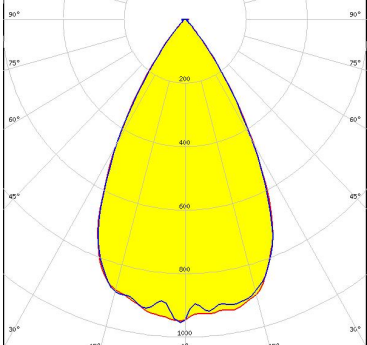
<p>LUMILEDS</p> <p>LED LUXEON CX Plus CoB - HD S04H9</p> <p>FWHM / FWTM 54.0° / 76.0°</p> <p>Efficiency 87 %</p> <p>Peak intensity 1.2 cd/lm</p> <p>LEDs/each optic 1</p> <p>Light colour White</p> <p>Required components: F15255_HEKLA-SOCKET-C</p>	
<p>LUMINUS</p> <p>LED CxM-14 (19x19)</p> <p>FWHM / FWTM 58.0° / 81.0°</p> <p>Efficiency 84 %</p> <p>Peak intensity 1 cd/lm</p> <p>LEDs/each optic 1</p> <p>Light colour White</p> <p>Required components: F17438_HEKLA-G2-I</p>	
<p>NICHIA</p> <p>LED COB L-Type (LES 11)</p> <p>FWHM / FWTM 56.0° / 77.0°</p> <p>Efficiency 86 %</p> <p>Peak intensity 1.1 cd/lm</p> <p>LEDs/each optic 1</p> <p>Light colour White</p> <p>Required components: F17437_HEKLA-G2-H</p>	
<p>OSRAM</p> <p>LED PrevaLED Core G7 LES15 CoB</p> <p>FWHM / FWTM 58.0° / 80.0°</p> <p>Efficiency 85 %</p> <p>Peak intensity 1 cd/lm</p> <p>LEDs/each optic 1</p> <p>Light colour White</p> <p>Required components: F17438_HEKLA-G2-I</p>	

OPTICAL RESULTS (SIMULATED):

SAMSUNG

LED LC003D / LC006D / LC009D / LC013D
FWHM / FWTM 54.0° / 76.0 + 75.0°
Efficiency 88 %
Peak intensity 1.2 cd/lm
LEDs/each optic 1
Light colour White
Required components:
F15255_HEKLA-SOCKET-C

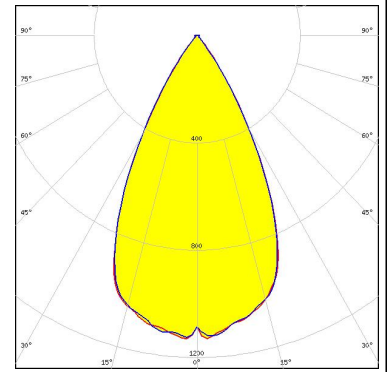

SAMSUNG

LED LC020T (Tunable white)
FWHM / FWTM 56.0° / 76.0°
Efficiency 87 %
Peak intensity 1.1 cd/lm
LEDs/each optic 1
Light colour White
Required components:
F15859_HEKLA-SOCKET-I

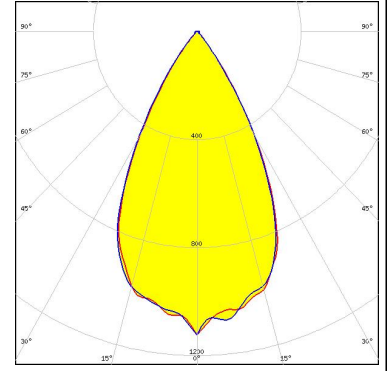

SAMSUNG

LED LC020T (Tunable white)
FWHM / FWTM 56.0° / 76.0°
Efficiency 86 %
Peak intensity 1.1 cd/lm
LEDs/each optic 1
Light colour White
Required components:
F15859_HEKLA-SOCKET-I

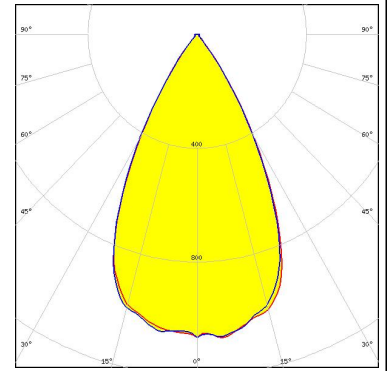

TRIDONIC

LED SLE G7 LES13
FWHM / FWTM 56.0° / 78.0°
Efficiency 86 %
Peak intensity 1 cd/lm
LEDs/each optic 1
Light colour White
Required components:
F15859_HEKLA-SOCKET-I

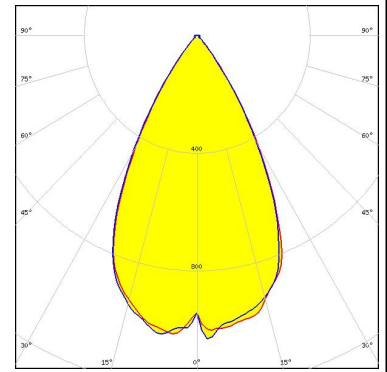

OPTICAL RESULTS (SIMULATED):

XICATO

LED	XOB 14.5 mm
FWHM / FWTM	55.0° / 76.0°
Efficiency	79 %
Peak intensity	1 cd/lm
LEDs/each optic	1
Light colour	White
Required components:	
	F17438_HEKLA-G2-I

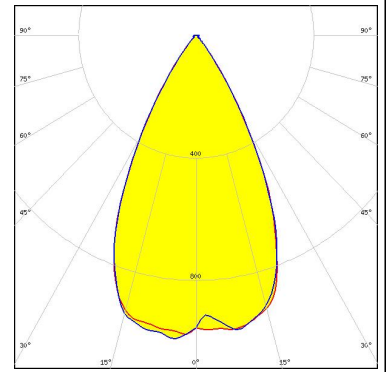

GENERAL INFORMATION:

NOTE: The typical beam angle will be changed by different color, chip size and chip position tolerance. The typical total beam angle is the full angle measured where the luminous intensity is half of the peak value.

Due to use of high power COB's with this product, special attention to proper thermal design is highly recommended. LEDiL has no liability for direct, indirect or consecutive damages arising from the LEDiL products being used outside of the recommended temperature range.

MATERIALS:

As part of our continuous research and improvement processes, and to ensure the best possible quality and availability of our products, LEDiL reserves the right to change material grades without notice.

PRODUCT DATA USER AGREEMENT AND DISCLAIMER:

The measured data in the provided downloadable LEDiL Product Datasheets and Mechanical 2D-Drawings is rounded and provided as reference for planning. LEDiL Oy's optical specifications have been verified by conducting performance testing of the products in accordance with the company's quality system. The reported data are averaged results of multiple measurements with typical variation. LEDiL Oy reserves the right to without prior notification make changes and improvements to its products.

LEDiL Oy assumes neither warranty, nor guarantee nor any other liability of any kind for the contents and correctness of the provided data. The provided data has been generated with highest diligence but the provided data may in reality not represent the complete possible variation range of all intrinsic parameters. Therefore, in certain cases a deviation from the provided data could occur.

LEDiL Oy reserves the right to undertake technical changes of its products without further notification which could lead to changes in the provided data. LEDiL Oy assumes no liability of any kind for the possible deviation from any provided data or any other damage resulting from the usage of the provided data.

The user agrees to this disclaimer and user agreement with the download or usage of the provided files.

LEDiL Oy

Joensuunkatu 13
FI-24240 SALO
Finland

LEDiL Inc.

228 West Page Street
Suite D
Sycamore IL 60178
USA

Ledil Optics Technology (Shenzhen) Co., Ltd.

405 , Block B
Casic Motor Building
Shenzhen 518057
P.R.CHINA

Local sales and technical support

[www.ledil.com/
where_to_buy](http://www.ledil.com/where_to_buy)

Shipping locations

Salo, Finland
Hong Kong, China

Distribution Partners

[www.ledil.com/
where_to_buy](http://www.ledil.com/where_to_buy)