

YASMEEN-70-ZOOM-C

Infinitely adjustable beam from 15 to 45 degrees.
Assembly with holder C compatible with LEDiL HEKLA. Black version.

SPECIFICATION:

Dimensions	Ø 72.9 mm
Height	46.7 mm
ROHS compliant	yes ⓘ



MATERIALS:

Component	Type	Material	Colour	Finish
C17736_YASMEEN-70-ZOOM-SUB	Single lens	PMMA		
CP17742_YASMEEN-70-ZOOM-C	Assembly			

ORDERING INFORMATION:

Quantities for one set:





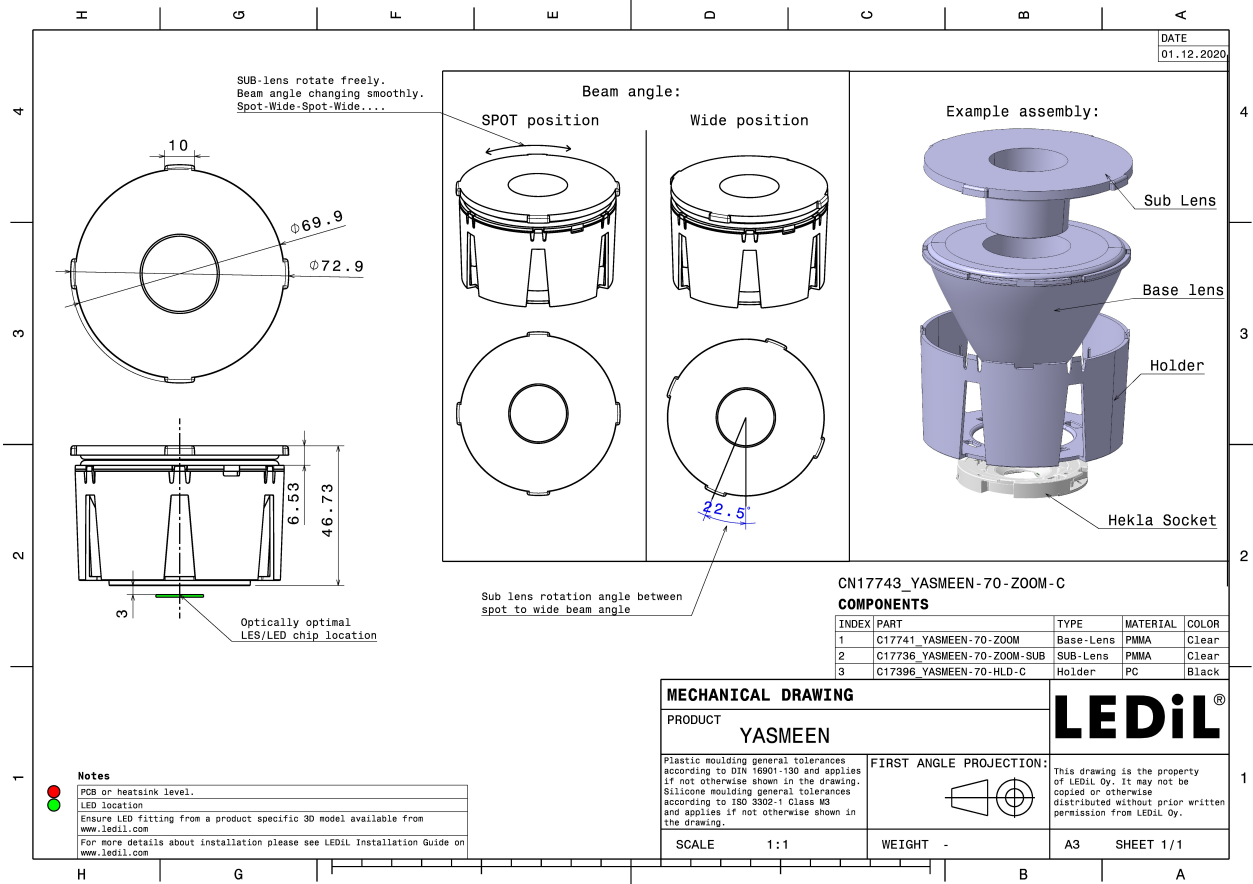



Single lens	1
Assembly	1

Component		Qty in box	MOQ	MPQ	Box weight (kg)
C17736_YASMEEN-70-ZOOM-SUB » Box size: 476 x 273 x 197 mm	Single lens	105	105	15	3.1
CP17742_YASMEEN-70-ZOOM-C » Box size: 476 x 273 x 305 mm	Assembly	105	105	15	10.8

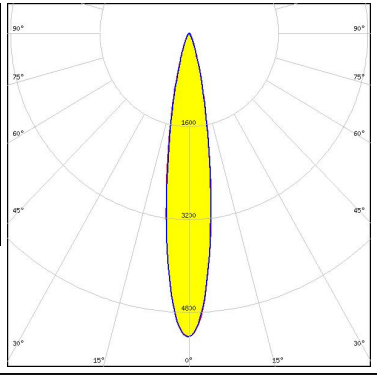

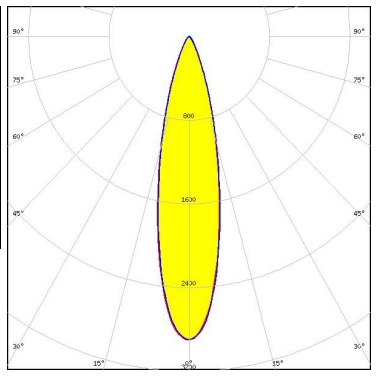
See also our general installation guide: www.ledil.com/installation_guide

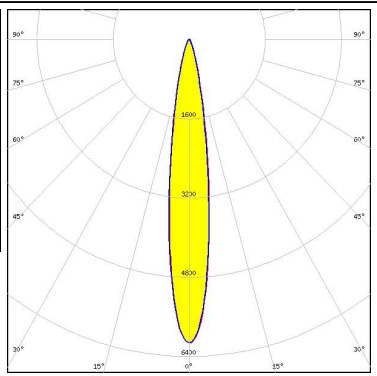
OPTICAL RESULTS (MEASURED):

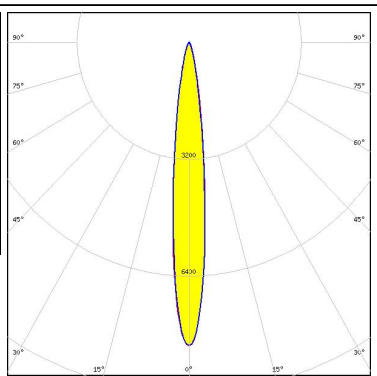
<p></p> <p>LED V10 Gen 8 FWHM / FWTM 18.0 + 41.0° / 36.0 + 72.0° Efficiency 77 % Peak intensity 5.2 cd/lm LEDs/each optic 1 Light colour White Required components: F15255_HEKLA-SOCKET-C</p>		
<p></p> <p>LED V13 Gen 8 FWHM / FWTM 24.0 + 42.0° / 49.0 + 77.0° Efficiency 75 % Peak intensity 2.9 cd/lm LEDs/each optic 1 Light colour White Required components: F15859_HEKLA-SOCKET-I</p>		
<p></p> <p>LED V8 Gen 8 FWHM / FWTM 15.0 + 40.0° / 34.0 + 71.0° Efficiency 78 % Peak intensity 6.1 cd/lm LEDs/each optic 1 Light colour White Required components: F15253_HEKLA-SOCKET-A</p>		
<p>SAMSUNG</p> <p>LED LC010C G2 FWHM / FWTM 12.0 + 41.0° / 28.0 + 70.0° Efficiency 76 % Peak intensity 8.3 cd/lm LEDs/each optic 1 Light colour White Required components: F17435_HEKLA-G2-C</p>		

OPTICAL RESULTS (SIMULATED):

CITIZEN

LED CLL02x/CLU02x (LES10)
 FWHM / FWTM 17.0 + 41.0° / 34.0 + 69.0°
 Efficiency 83 %
 Peak intensity 6.7 cd/lm
 LEDs/each optic 1
 Light colour White
 Required components:
 F17435_HEKLA-G2-C

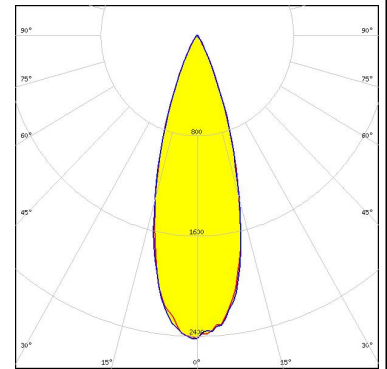

CITIZEN

LED CLL03x/CLU03x
 FWHM / FWTM 24.0 + 41.0° / 47.0 + 74.0°
 Efficiency 80 %
 Peak intensity 3.5 cd/lm
 LEDs/each optic 1
 Light colour White
 Required components:
 F17438_HEKLA-G2-I

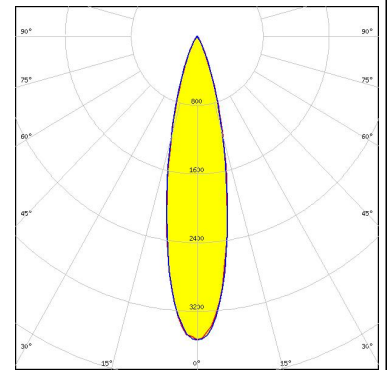

CITIZEN

LED CLU700/701/702/703
 FWHM / FWTM 12.0 + 41.0° / 26.0 + 65.0°
 Efficiency 84 %
 Peak intensity 11.6 cd/lm
 LEDs/each optic 1
 Light colour White
 Required components:
 F17435_HEKLA-G2-C

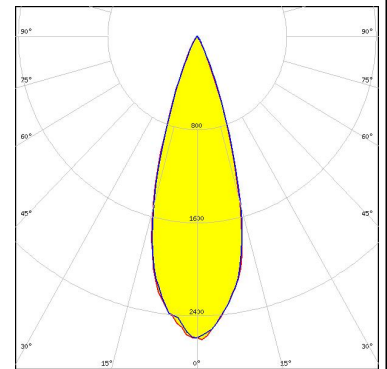

CITIZEN

LED CLU712/713
 FWHM / FWTM 14.0 + 41.0° / 28.0 + 68.0°
 Efficiency 85 %
 Peak intensity 11.6 cd/lm
 LEDs/each optic 1
 Light colour White
 Required components:
 F17438_HEKLA-G2-I

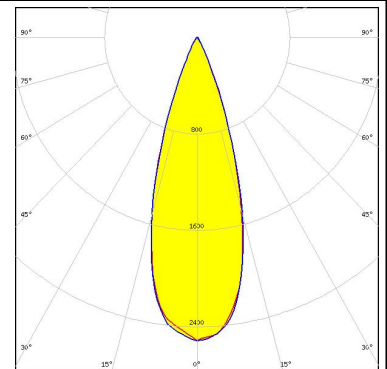

OPTICAL RESULTS (SIMULATED):

<p>LUMILEDS</p> <p>LED LUXEON CoB 1202/1203 FWHM / FWTM 22.0 + 42.0° / 42.0 + 74.0° Efficiency 83 % Peak intensity 4.5 cd/lm LEDs/each optic 1 Light colour White Required components: F17437_HEKLA-G2-H</p>	
<p>LUMILEDS</p> <p>LED LUXEON CoB 1204/1205 FWHM / FWTM 18.0 + 42.0° / 38.0 + 71.0° Efficiency 73 % Peak intensity 4.9 cd/lm LEDs/each optic 1 Light colour White Required components: Bender Wirth: 632a Hekla XL</p>	
<p>SAMSUNG</p> <p>LED LC003D / LC006D / LC009D / LC013D FWHM / FWTM 17.0 + 41.0° / 34.0 + 69.0° Efficiency 83 % Peak intensity 6.8 cd/lm LEDs/each optic 1 Light colour White Required components: F17435_HEKLA-G2-C</p>	
<p>SAMSUNG</p> <p>LED LC020T (Tunable white) FWHM / FWTM 18.0 + 42.0° / 36.0 + 71.0° Efficiency 84 % Peak intensity 6 cd/lm LEDs/each optic 1 Light colour Tunable White Required components: C16142_HEKLA-SOCKET-K Bender Wirth: 501 Typ L8</p>	

OPTICAL RESULTS (SIMULATED):

XICATO

LED XOB 14.5 mm
FWHM / FWTM 20.0 + 42.0° / 43.0 + 74.0°
Efficiency 81 %
Peak intensity 4.4 cd/lm
LEDs/each optic 1
Light colour White
Required components:
F17438_HEKLA-G2-I

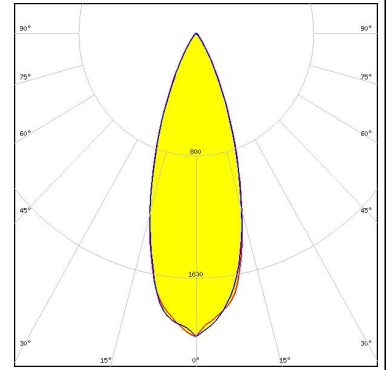

XICATO

LED XOB 9.8 mm
FWHM / FWTM 16.0 + 42.0° / 30.0 + 68.0°
Efficiency 85 %
Peak intensity 8.5 cd/lm
LEDs/each optic 1
Light colour White
Required components:
F17435_HEKLA-G2-C

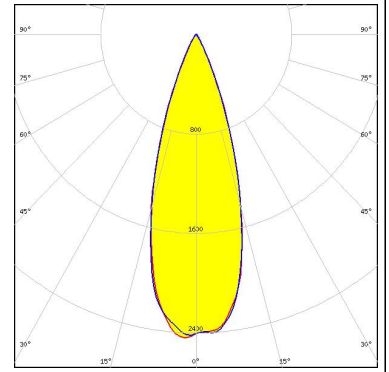

GENERAL INFORMATION:

NOTE: The typical beam angle will be changed by different color, chip size and chip position tolerance. The typical total beam angle is the full angle measured where the luminous intensity is half of the peak value.

Due to use of high power COB's with this product, special attention to proper thermal design is highly recommended. LEDiL has no liability for direct, indirect or consecutive damages arising from the LEDiL products being used outside of the recommended temperature range.

MATERIALS:

As part of our continuous research and improvement processes, and to ensure the best possible quality and availability of our products, LEDiL reserves the right to change material grades without notice.

PRODUCT DATA USER AGREEMENT AND DISCLAIMER:

The measured data in the provided downloadable LEDiL Product Datasheets and Mechanical 2D-Drawings is rounded and provided as reference for planning. LEDiL Oy's optical specifications have been verified by conducting performance testing of the products in accordance with the company's quality system. The reported data are averaged results of multiple measurements with typical variation. LEDiL Oy reserves the right to without prior notification make changes and improvements to its products.

LEDiL Oy assumes neither warranty, nor guarantee nor any other liability of any kind for the contents and correctness of the provided data. The provided data has been generated with highest diligence but the provided data may in reality not represent the complete possible variation range of all intrinsic parameters. Therefore, in certain cases a deviation from the provided data could occur.

LEDiL Oy reserves the right to undertake technical changes of its products without further notification which could lead to changes in the provided data. LEDiL Oy assumes no liability of any kind for the possible deviation from any provided data or any other damage resulting from the usage of the provided data.

The user agrees to this disclaimer and user agreement with the download or usage of the provided files.

LEDiL Oy

Joensuunkatu 13
FI-24240 SALO
Finland

LEDiL Inc.

228 West Page Street
Suite D
Sycamore IL 60178
USA

Ledil Optics Technology (Shenzhen) Co., Ltd.

405 , Block B
Casic Motor Building
Shenzhen 518057
P.R.CHINA

Local sales and technical support

[www.ledil.com/
where_to_buy](http://www.ledil.com/where_to_buy)

Shipping locations

Salo, Finland
Hong Kong, China

Distribution Partners

[www.ledil.com/
where_to_buy](http://www.ledil.com/where_to_buy)