

XCKL506

Limit switch, Limit switches XC Standard, XCKL, cats whisker, 1NC+1 NO, slow break, Cable gland

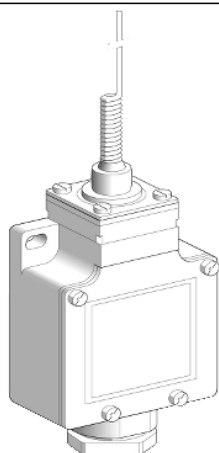

Main

Range of Product	Telemecanique Limit switches XC Standard
Series name	Standard format
Product or Component Type	Limit switch
Device short name	XCKL
Body type	Fixed
Head type	Multi-directional head
Material	Metal
Body Material	Zamak
Fixing Mode	By the body
Movement of operating head	Multi-directional
Type of operator	Spring return cat's whisker
Type of approach	Multi-directional approach
Cable entry	1 metal cable gland entry 0.24...0.53 in (6...13.5 mm)
Number of poles	2
Contacts type and composition	1 NC + 1 NO
Contact operation	Slow-break, break before make

Complementary

Switch actuation	By any moving part
Electrical connection	Screw-clamp terminals 1 x 0.5...2 x 2.5 mm ²
Contacts insulation form	Zb
Number of steps	1
Positive opening	Without
Minimum torque for tripping	1.15 lbf.in (0.13 N.m)
Minimum actuation speed	6 m/min
Maximum actuation speed	3.28 ft/s (1 m/s)
Contact code designation	A300, AC-15 (U _e = 240 V), I _e = 3 A EN/IEC 60947-5-1 appendix A Q300, DC-13 (U _e = 250 V), I _e = 0.27 A EN/IEC 60947-5-1 appendix A
[I _{th}] conventional enclosed thermal current	10 A AC
[U _i] rated insulation voltage	300 VUL 508 500 V 3)IEC 60947-1 300 VCSA C22.2 No 14
Maximum resistance across terminals	25 MOhm IEC 60255-7 category 3
[U _{imp}] rated impulse withstand voltage	6 kV IEC 60664 6 kV IEC 60947-1
Short-circuit protection	10 A cartridge fuse gG
Electrical durability	5000000 Cycles, DC-13, inductive, 120 V, 4 W 60 cyc/mn 0.5 IEC 60947-5-1 appendix C 5000000 Cycles, DC-13, inductive, 24 V, 7 W 60 cyc/mn 0.5 IEC 60947-5-1 appendix C 5000000 cycles, DC-13, inductive, 48 V, 10 W 60 cyc/mn 0.5 IEC 60947-5-1 appendix C
Mechanical durability	10000000 cycles
Width	2.05 in (52 mm)
Height	2.83 in (72 mm)

Depth	1.18 in (30 mm)
Net Weight	0.56 lb(US) (0.255 kg)
Terminals description ISO n°1	(21-22)NC (13-14)NO

Environment

Shock resistance	50 gn 11 ms EN/IEC 60068-2-27
Vibration resistance	25 gn 10...500 Hz)EN/IEC 60068-2-6
IP degree of protection	IP66 conforming to EN/IEC 60529
IK degree of protection	IK05 EN 50102
Electrical shock protection class	Class I IEC 61140 Class I NF C 20-030
Ambient Air Temperature for Operation	-13...158 °F (-25...70 °C)
Ambient Air Temperature for Storage	-40...158 °F (-40...70 °C)
Protective treatment	TC
Product Certifications	UL CSA
Standards	IEC 60204-1 CSA C22.2 No 14 UL 508 IEC 60947-5-1 EN 60947-5-1 EN 60204-1





Ordering and shipping details

Category	22416-LIMIT SWITCHES,IEC,XCKL
Discount Schedule	T
GTIN	3389110646610
Nbr. of units in pkg.	1
Package weight(Lbs)	9.31 oz (264.0 g)
Returnability	No
Country of origin	FR

Packing Units

Unit Type of Package 1	PCE
Package 1 Height	1.34 in (3.4 cm)
Package 1 width	2.60 in (6.6 cm)
Package 1 Length	8.74 in (22.2 cm)

Offer Sustainability

Sustainable offer status	Green Premium product
California proposition 65	WARNING: This product can expose you to chemicals including: Diisononyl phthalate (DINP), which is known to the State of California to cause cancer, and Di-isodecyl phthalate (DIDP), which is known to the State of California to cause birth defects or other reproductive harm. For more information go to www.P65Warnings.ca.gov
REACH Regulation	 REACH Declaration
EU RoHS Directive	Pro-active compliance (Product out of EU RoHS legal scope)  EU RoHS Declaration
Mercury free	Yes
RoHS exemption information	 Yes
Environmental Disclosure	 Product Environmental Profile

Contractual warranty

Warranty	18 months
----------	-----------

Dimensions

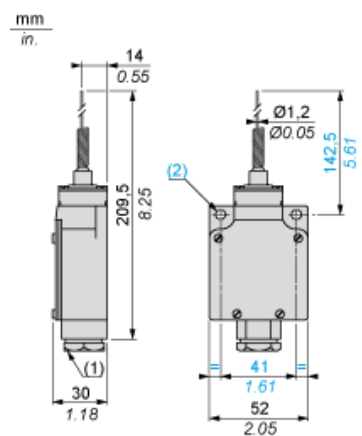

- (1) Pg 13.5 cable gland
Ø : 2 elongated holes $\varnothing 5.2 \times 6.2$

Mounting with Cable Entry

Position of Cable Gland



- (1) Recommended
- (2) To be avoided

Wiring Diagram

2-pole NC + NO Break Before Make, Slow Break



Characteristics of Actuation

Switch Actuation by Any Moving Part

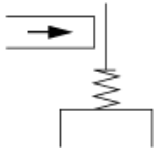

Functionnal Diagram

