

ELLA-30-S

~15° spot beam. Assembly with black holder.

SPECIFICATION:

Dimensions	Ø 32.0 mm
Height	20 mm
Fastening	tape
ROHS compliant	yes ⓘ

MATERIALS:

Component	Type	Material	Colour	Finish
ELLA-30-S	Reflector	HTPC	metal	
OLGA-HLD	Holder	PC	black	
SPUTNIK-TAPE3	Tape	Acrylic foam	black	



ORDERING INFORMATION:

Component	Type	Qty in box	MOQ	MPQ	Box weight (kg)
CA17280_ELLA-30-S	Reflector	792	264	66	5.8
» Box size: 480 x 280 x 300 mm					

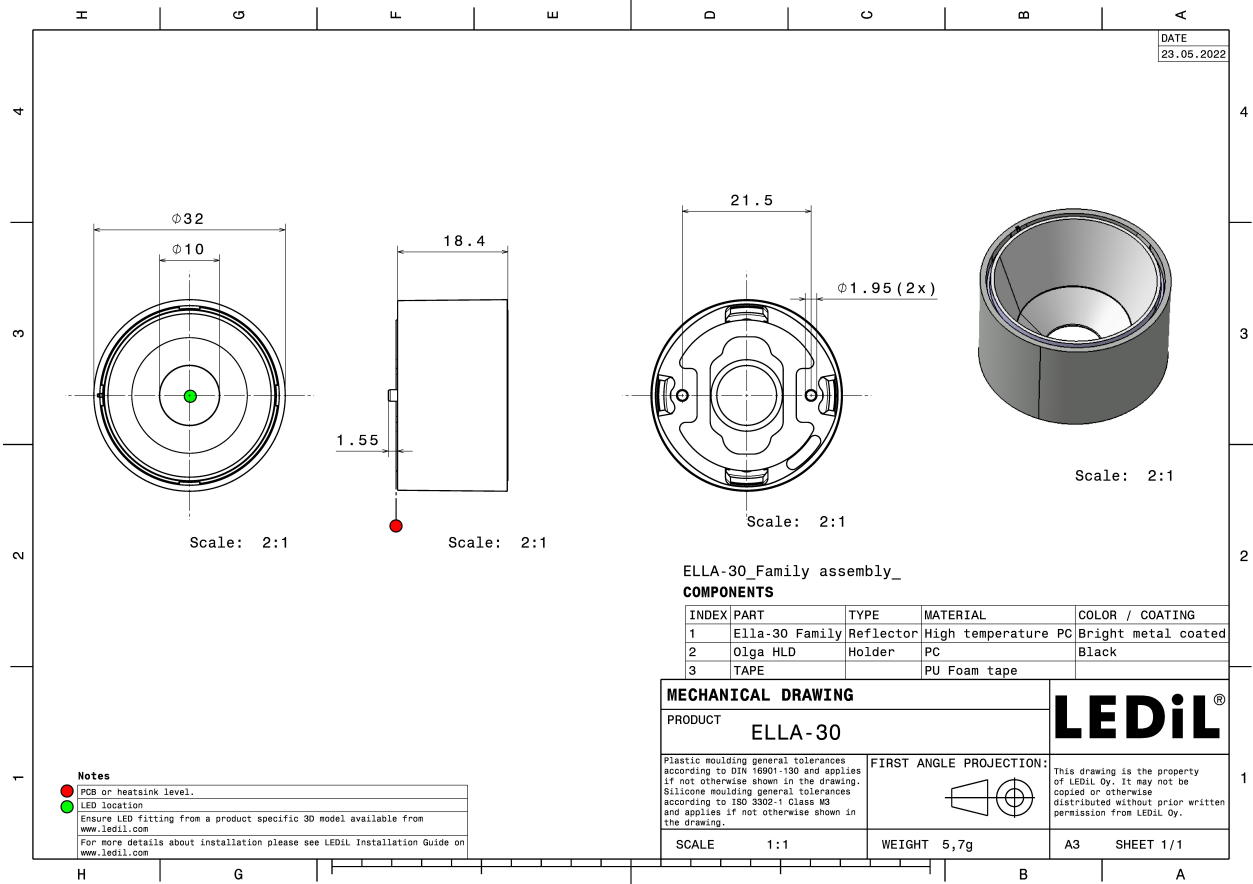

See also our general installation guide: www.ledil.com/installation_guide

OPTICAL RESULTS (MEASURED):



LED XHP35 HD
 FWHM / FWTM 13.0° / 23.0°
 Efficiency 88 %
 Peak intensity 10.3 cd/lm
 LEDs/each optic 1
 Light colour White
 Required components:

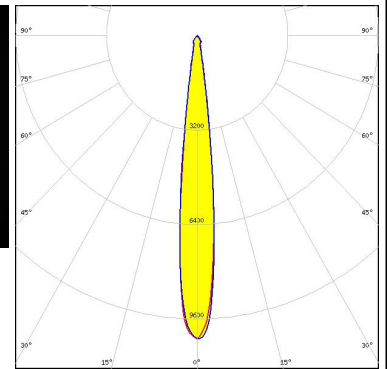

LED XP-L2
 FWHM / FWTM 12.0° / 23.0°
 Efficiency 86 %
 Peak intensity 11.5 cd/lm
 LEDs/each optic 1
 Light colour White
 Required components:

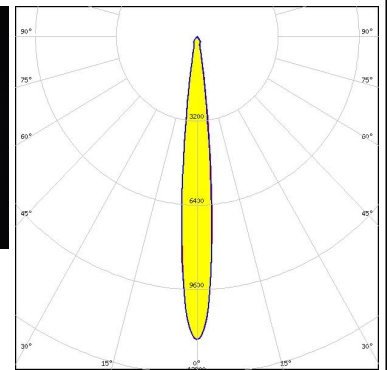

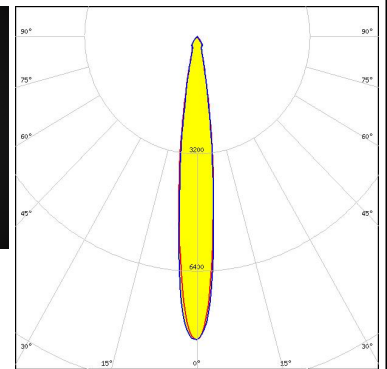
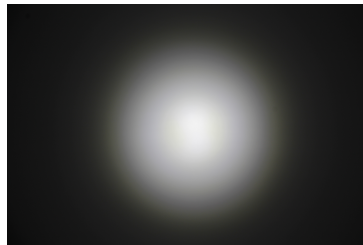

LED LUXEON 5050 Round LES
 FWHM / FWTM 14.0° / 29.0°
 Efficiency 91 %
 Peak intensity 8.3 cd/lm
 LEDs/each optic 1
 Light colour White
 Required components:

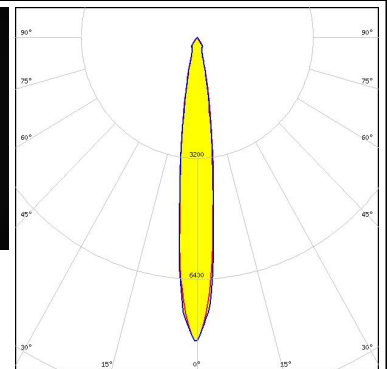
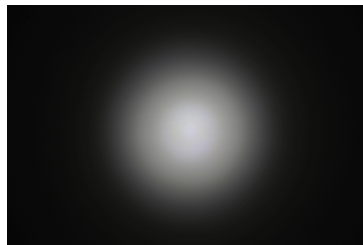

LED NFMW48xA
 FWHM / FWTM 13.0 + 14.0° / 30.0°
 Efficiency 90 %
 Peak intensity 8 cd/lm
 LEDs/each optic 1
 Light colour White
 Required components:

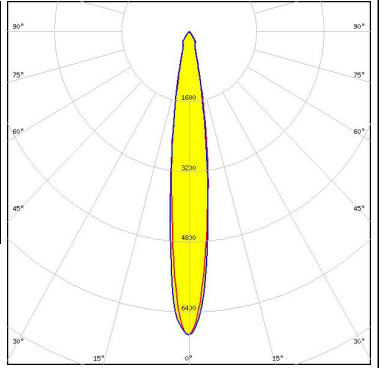

OPTICAL RESULTS (MEASURED):

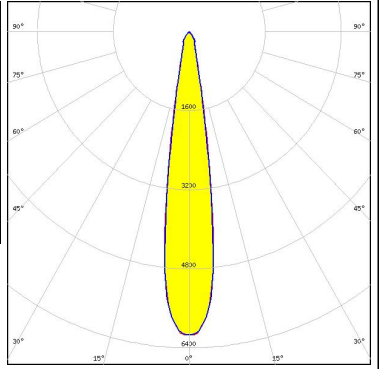
<p>OSRAM Opto Semiconductors</p> <p>LED Duris S8</p> <p>FWHM / FWTM 15.0° / 33.0°</p> <p>Efficiency 90 %</p> <p>Peak intensity 6.9 cd/m</p> <p>LEDs/each optic 1</p> <p>Light colour White</p> <p>Required components:</p>		
<p>SEOUL SEOUL SEMICONDUCTOR</p> <p>LED WICOP 5050</p> <p>FWHM / FWTM 17.0° / 32.0°</p> <p>Efficiency 86 %</p> <p>Peak intensity 6.2 cd/m</p> <p>LEDs/each optic 1</p> <p>Light colour White</p> <p>Required components:</p>		

OPTICAL RESULTS (SIMULATED):



LED XHP50.3 HD
 FWHM / FWTM 14.0° / 27.0°
 Efficiency 91 %
 Peak intensity 8.2 cd/lm
 LEDs/each optic 1
 Light colour White
 Required components:

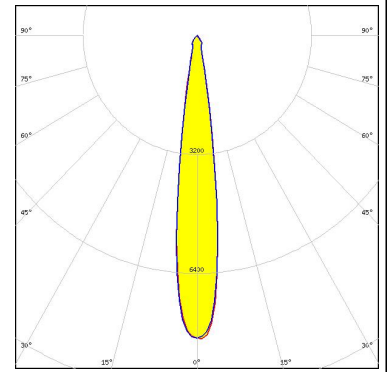

LED XHP70.3 HD
 FWHM / FWTM 22.0° / 42.0°
 Efficiency 86 %
 Peak intensity 4.1 cd/lm
 LEDs/each optic 1
 Light colour White
 Required components:

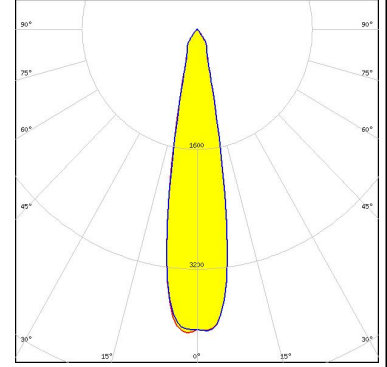

LED XHP70.3 HI
 FWHM / FWTM 14.0° / 30.0°
 Efficiency 88 %
 Peak intensity 7.4 cd/lm
 LEDs/each optic 1
 Light colour White
 Required components:

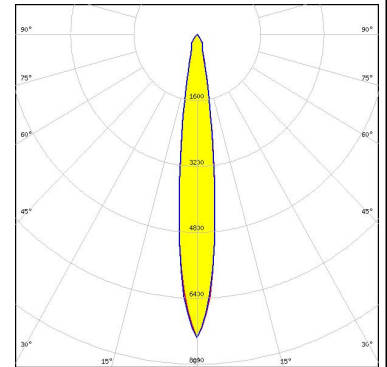

LED LH351C
 FWHM / FWTM 8.0° / 16.0°
 Efficiency 90 %
 Peak intensity 20.5 cd/lm
 LEDs/each optic 1
 Light colour White
 Required components:

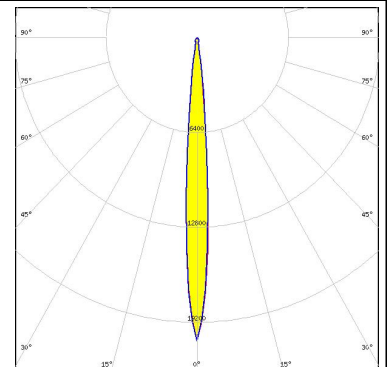

OPTICAL RESULTS (SIMULATED):

SAMSUNG

LED	LH351D
FWHM / FWTM	11.0° / 20.0°
Efficiency	88 %
Peak intensity	13.4 cd/lm
LEDs/each optic	1
Light colour	White
Required components:	

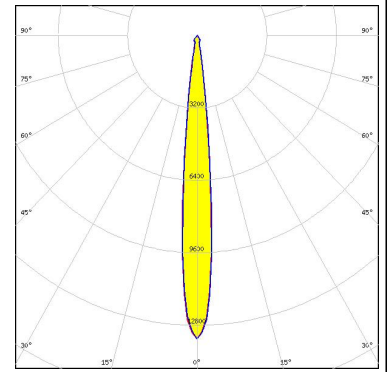

GENERAL INFORMATION:

NOTE: The typical beam angle will be changed by different color, chip size and chip position tolerance. The typical total beam angle is the full angle measured where the luminous intensity is half of the peak value.

MATERIALS:

As part of our continuous research and improvement processes, and to ensure the best possible quality and availability of our products, LEDiL reserves the right to change material grades without notice.

PRODUCT DATA USER AGREEMENT AND DISCLAIMER:

The measured data in the provided downloadable LEDiL Product Datasheets and Mechanical 2D-Drawings is rounded and provided as reference for planning. LEDiL Oy's optical specifications have been verified by conducting performance testing of the products in accordance with the company's quality system. The reported data are averaged results of multiple measurements with typical variation. LEDiL Oy reserves the right to without prior notification make changes and improvements to its products.

LEDiL Oy assumes neither warranty, nor guarantee nor any other liability of any kind for the contents and correctness of the provided data. The provided data has been generated with highest diligence but the provided data may in reality not represent the complete possible variation range of all intrinsic parameters. Therefore, in certain cases a deviation from the provided data could occur.

LEDiL Oy reserves the right to undertake technical changes of its products without further notification which could lead to changes in the provided data. LEDiL Oy assumes no liability of any kind for the possible deviation from any provided data or any other damage resulting from the usage of the provided data.

The user agrees to this disclaimer and user agreement with the download or usage of the provided files.

LEDiL Oy

Joensuunkatu 13
FI-24240 SALO
Finland

LEDiL Inc.

228 West Page Street
Suite D
Sycamore IL 60178
USA

Ledil Optics Technology (Shenzhen) Co., Ltd.

405 , Block B
Casic Motor Building
Shenzhen 518057
P.R.CHINA

Local sales and technical support

[www.ledil.com/
where_to_buy](http://www.ledil.com/where_to_buy)

Shipping locations

Salo, Finland
Hong Kong, China

Distribution Partners

[www.ledil.com/
where_to_buy](http://www.ledil.com/where_to_buy)