

# WL50S Stainless Steel High-Intensity Work Spot Light



## Datasheet

Chemically Resistant LED work lighting



- Three lens options, depending on model, to vary spot size
- Illuminates a large area with an even pattern of light and no shadows
- 12 to 30 V dc operation
- 56 mm (2.2 in) diameter with flat profile and 30 mm (1.2 in) mounting base
- Rugged, Viton® o-ring sealed housing rated to IP69K
- Chemically resistant 316 stainless steel housing for use in harsh environments
- FDA grade silicone gasket



### WARNING: Not To Be Used for Personnel Protection

Never use this device as a sensing device for personnel protection. Doing so could lead to serious injury or death. This device does not include the self-checking redundant circuitry necessary to allow its use in personnel safety applications. A sensor failure or malfunction can cause either an energized or de-energized sensor output condition.

## Models

Model	LED Color	Window Material	Lumens	Lux		Lens Angle (see <a href="#">Beam Patterns</a> on page 2)	Connection
				0.5 m	1 m		
WL50SWSSL5Q	White, 5000–8300 K	Polycarbonate	295	13780	3445	±5° small, more focused spot	5 pin Euro integral QD connector (use with a 4- wire or 5-wire mating cordset, only 2 wires used for connection)
WL50SWSSGL5Q		Glass					
WL50SWSSL11Q		Polycarbonate	285	5460	1365	±11° larger spot	
WL50SWSSGL11Q		Glass					
WL50SWSSL20Q		Polycarbonate	270	2000	500	±20° largest spot	
WL50SWSSGL20Q		Glass					

## Specifications

### Supply Voltage and Current

Operating Voltage: 12 to 30 V dc  
Current Draw: 400 mA maximum

### Supply Protection Circuitry

Protected against reverse polarity and transient voltages

### Light Source

Three high-intensity LEDs; see models table for color temperature

### Useful Life

When operating within specifications, output will decrease less than 30% after 50,000 hours.

### Construction

316 stainless steel housing, polycarbonate or glass window with Viton seal, 316 stainless steel M30 mounting nut, FDA grade silicon base gasket

### Mounting

30 × 1.5 mm thread base mount

### Connections

Integral 5-pin M12 quick disconnect fitting; 4-pin connecting cordset required for quick disconnect fitting models; only 2 wires used

### Environmental Rating

IEC IEC IP67, IEC IP69K per DIN 40050-9



**NOTE:** Do not spray the cable with a high-pressure sprayer or cable damage will result.

### Operating Conditions

–20 °C to +50 °C (–4 °F to +122 °F)  
95% maximum relative humidity (non-condensing)

### Vibration and Mechanical Shock

All models meet Mil. Std. 202F requirements method 201A (vibration: 10 to 60 Hz max., double amplitude 0.06", maximum acceleration 10G). Also meets IEC 947-5-2; 30G 11 ms duration, half sine wave.

### Storage Temperature

–40 °C to +70 °C (–40 °F to +158 °F)  
95% maximum relative humidity (non-condensing)

### Certifications

Approvals are pending



### Beam Patterns

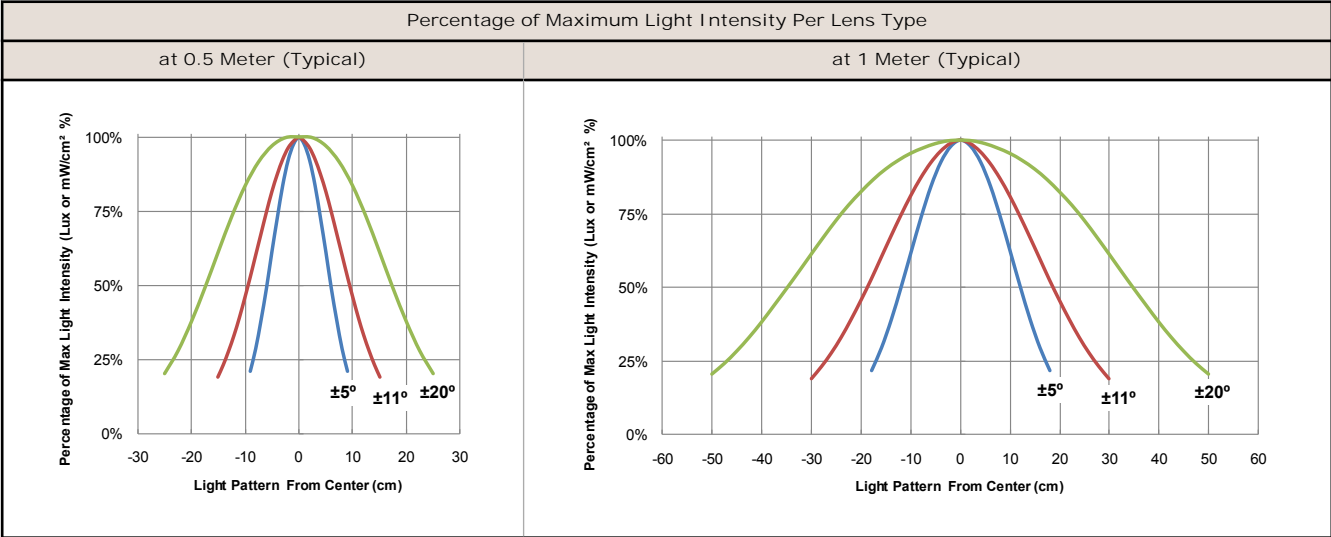

### Dimensions

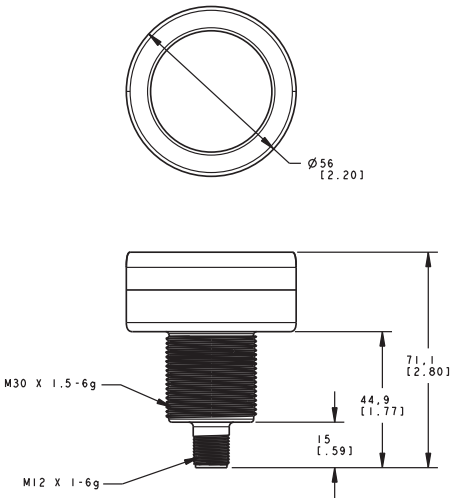

### Wiring

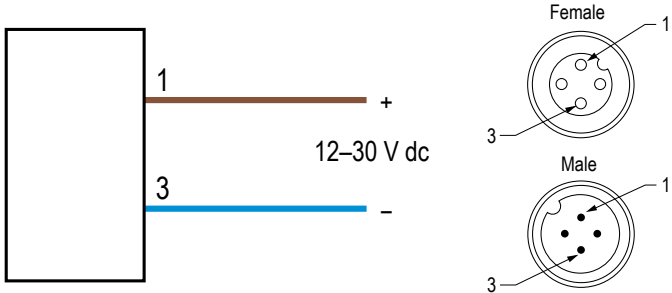

Wiring Key:  
 1 = Brown  
 3 = Blue

## Accessories

### Cordsets

#### Standard Cordsets

4-Pin Threaded M12/Euro-Style Cordsets				
Model	Length	Style	Dimensions	Pinout (Female)
MQDC-406	1.83 m (6 ft)	Straight		<p>1 = Brown 2 = White 3 = Blue 4 = Black</p>
MQDC-415	4.57 m (15 ft)			
MQDC-430	9.14 m (30 ft)			
MQDC-450	15.2 m (50 ft)			
MQDC-406RA	1.83 m (6 ft)	Right-Angle		
MQDC-415RA	4.57 m (15 ft)			
MQDC-430RA	9.14 m (30 ft)			
MQDC-450RA	15.2 m (50 ft)			

#### Washdown Rated Cordsets

Polypropylene jacket and connector body, stainless steel coupling nut

5-Pin Threaded M12/Euro-Style Cordsets—Washdown, with Shield				
Model	Length	Style	Dimensions	Pinout (Female)
MQDCWD-506	1.83 m (6 ft)	Straight		<p>1 = Brown 2 = White 3 = Blue 4 = Black 5 = Gray</p>
MQDCWD-530	9.14 m (30 ft)			

## Mounting Brackets

All measurements are in mm

#### SMB30A

- Right-angle bracket with curved slot for versatile orientation
- Clearance for M6 (¼ in) hardware
- Mounting hole for 30 mm sensor
- 12-ga. stainless steel

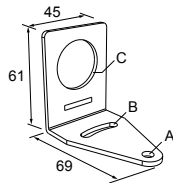

Hole center spacing: A to B=40  
Hole size: A=ø 6.3, B= 27.1 x 6.3, C=ø 30.5

#### SMB30SC

- Swivel bracket with 30 mm mounting hole for sensor
- Black reinforced thermoplastic polyester
- Stainless steel mounting and swivel locking hardware included

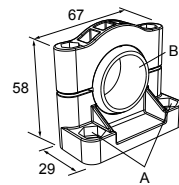

Hole center spacing: A=ø 50.8  
Hole size: A=ø 7.0, B=ø 30.0

SMB30FA

- Swivel bracket with tilt and pan movement for precise adjustment
- Mounting hole for 30 mm sensor
- 12-ga. 304 stainless steel
- Easy sensor mounting to extrude rail T-slot
- Metric and inch size bolt available

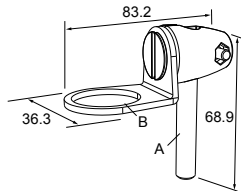

Bolt thread: SMB30FA, A= 3/8 - 16 x 2 in; SMB30FAM10, A= M10 - 1.5 x 50  
 Hole size: B= ø 30.1

SMBAMS30RA

- Right-angle SMBAMS series bracket
- 30 mm hole for mounting sensors
- Articulation slots for 90° + rotation
- 12-ga. (2.6 mm) cold-rolled steel

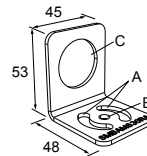

Hole center spacing: A=26.0, A to B=13.0  
 Hole size: A=26.8 x 7.0, B=ø 6.5, C=ø 31.0

SMB30MM

- 12-ga. stainless steel bracket with curved mounting slots for versatile orientation
- Clearance for M6 (1/4 in) hardware
- Mounting hole for 30 mm sensor

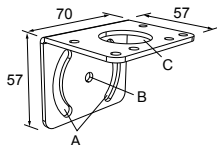

Hole center spacing: A = 51, A to B = 25.4  
 Hole size: A = 42.6 x 7, B = ø 6.4, C = ø 30.1

SMBAMS30P

- Flat SMBAMS series bracket
- 30 mm hole for mounting sensors
- Articulation slots for 90° + rotation
- 12-ga. 300 series stainless steel

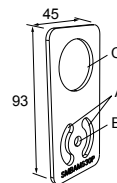

Hole center spacing: A=26.0, A to B=13.0  
 Hole size: A=26.8 x 7.0, B=ø 6.5, C=ø 31.0

## Banner Engineering Corp. Limited Warranty

Banner Engineering Corp. warrants its products to be free from defects in material and workmanship for one year following the date of shipment. Banner Engineering Corp. will repair or replace, free of charge, any product of its manufacture which, at the time it is returned to the factory, is found to have been defective during the warranty period. This warranty does not cover damage or liability for misuse, abuse, or the improper application or installation of the Banner product.

THIS LIMITED WARRANTY IS EXCLUSIVE AND IN LIEU OF ALL OTHER WARRANTIES WHETHER EXPRESS OR IMPLIED (INCLUDING, WITHOUT LIMITATION, ANY WARRANTY OF MERCHANTABILITY OR FITNESS FOR A PARTICULAR PURPOSE), AND WHETHER ARISING UNDER COURSE OF PERFORMANCE, COURSE OF DEALING OR TRADE USAGE.

This Warranty is exclusive and limited to repair or, at the discretion of Banner Engineering Corp., replacement. IN NO EVENT SHALL BANNER ENGINEERING CORP. BE LIABLE TO BUYER OR ANY OTHER PERSON OR ENTITY FOR ANY EXTRA COSTS, EXPENSES, LOSSES, LOSS OF PROFITS, OR ANY INCIDENTAL, CONSEQUENTIAL OR SPECIAL DAMAGES RESULTING FROM ANY PRODUCT DEFECT OR FROM THE USE OR INABILITY TO USE THE PRODUCT, WHETHER ARISING IN CONTRACT OR WARRANTY, STATUTE, TORT, STRICT LIABILITY, NEGLIGENCE, OR OTHERWISE.

Banner Engineering Corp. reserves the right to change, modify or improve the design of the product without assuming any obligations or liabilities relating to any product previously manufactured by Banner Engineering Corp. Any misuse, abuse, or improper application or installation of this product or use of the product for personal protection applications when the product is identified as not intended for such purposes will void the product warranty. Any modifications to this product without prior express approval by Banner Engineering Corp will void the product warranties. All specifications published in this document are subject to change: Banner reserves the right to modify product specifications or update documentation at any time. Specifications and product information in English supersede that which is provided in any other language. For the most recent version of any documentation, refer to: [www.bannerengineering.com](http://www.bannerengineering.com).