

## ILONA-RS

~10° spot beam

### SPECIFICATION:

Dimensions	Ø 49.8 mm
Height	29.3 mm
Fastening	socket
ROHS compliant	yes ⓘ

### MATERIALS:

Component	Type	Material	Colour	Finish
ILONA-RS	Single lens	PMMA	clear	







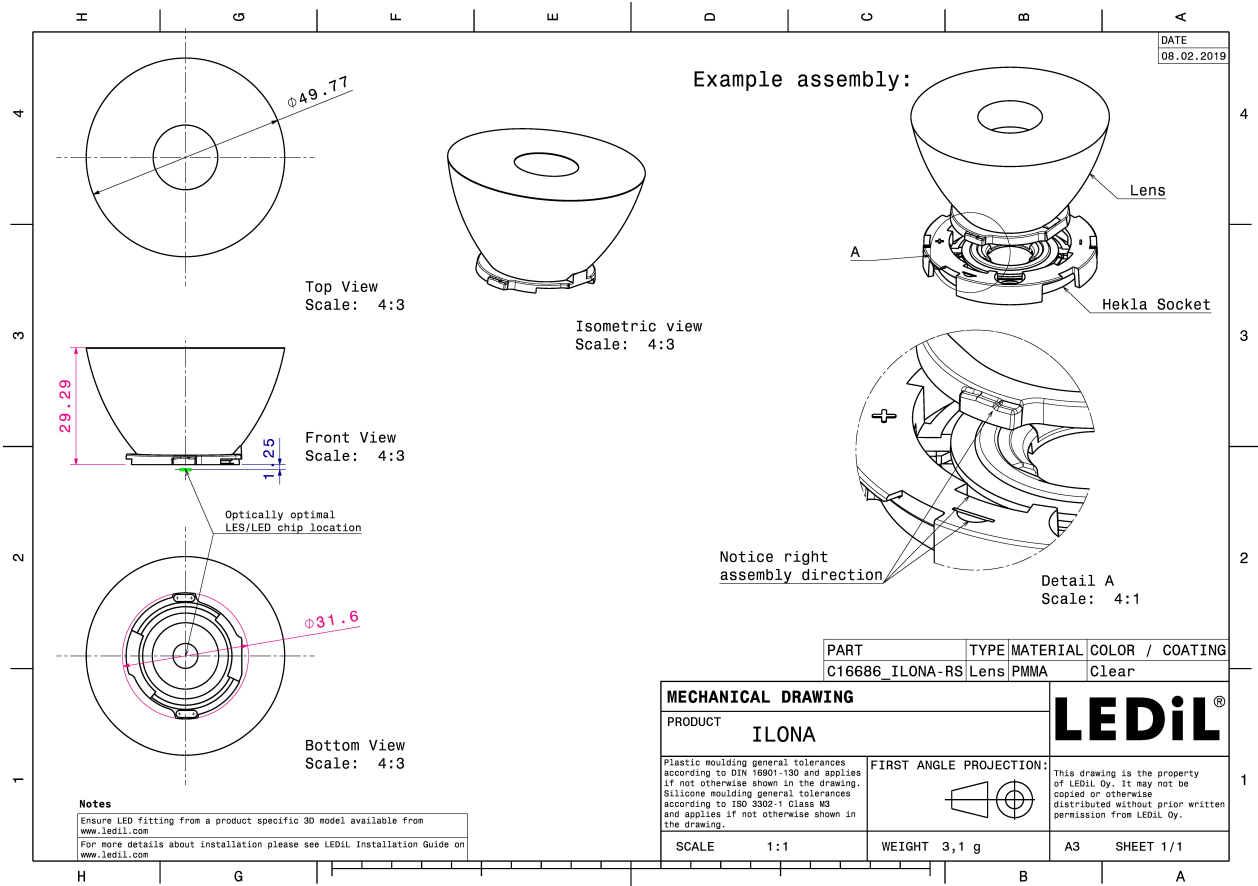



### ORDERING INFORMATION:

Component	Qty in box	MOQ	MPQ	Box weight (kg)
C16686_ILONA-RS » Box size: 480 x 280 x 300 mm	264	99	33	9.6

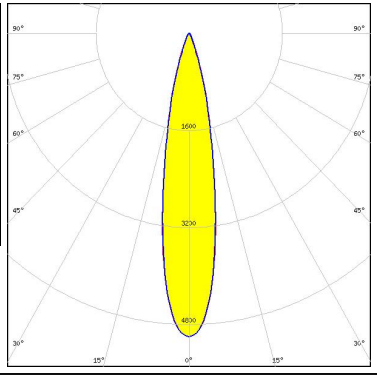

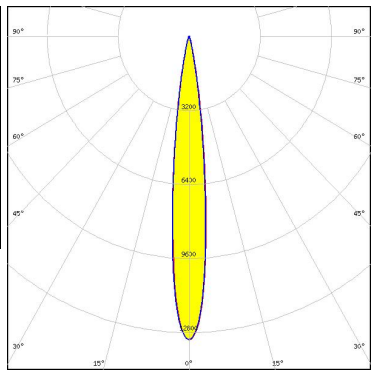

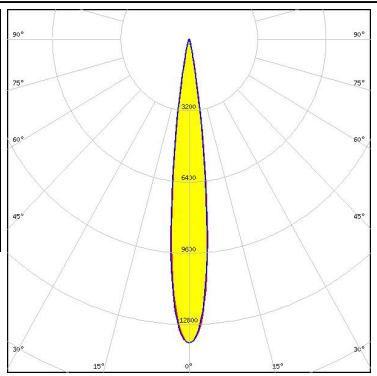

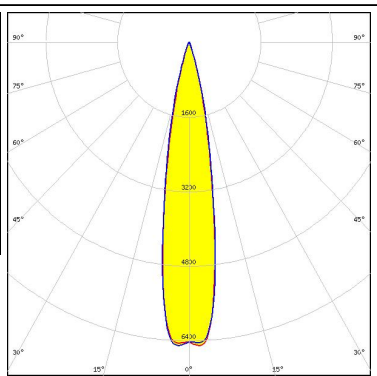



See also our general installation guide: [www.ledil.com/installation\\_guide](http://www.ledil.com/installation_guide)

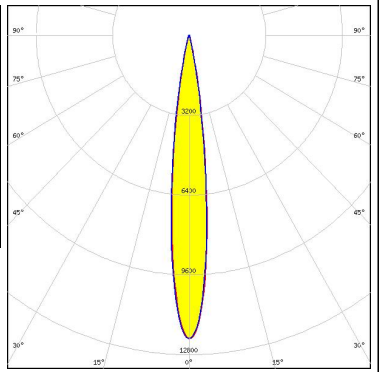

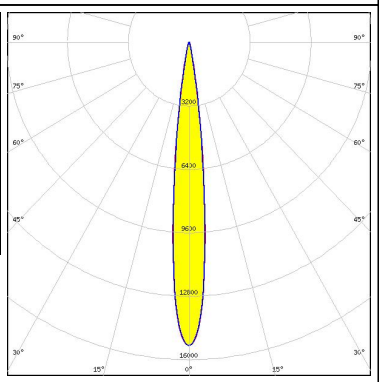

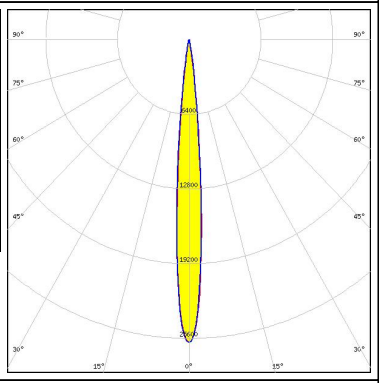
#### OPTICAL RESULTS (MEASURED):

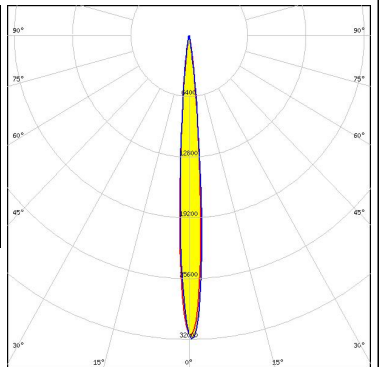
<p></p> <p>LED V11 HD Gen 8</p> <p>FWHM / FWTM 20.0° / 40.0°</p> <p>Efficiency 93 %</p> <p>Peak intensity 5 cd/lm</p> <p>LEDs/each optic 1</p> <p>Light colour White</p> <p>Required components: Bender Wirth: 633d Hekla</p>		
<p></p> <p>LED V6 HD Gen 7</p> <p>FWHM / FWTM 13.0° / 24.0°</p> <p>Efficiency 94 %</p> <p>Peak intensity 13.1 cd/lm</p> <p>LEDs/each optic 1</p> <p>Light colour White</p> <p>Required components: Bender Wirth: 634c Hekla</p>		
<p></p> <p>LED V6 HD Gen 7</p> <p>FWHM / FWTM 14.0° / 23.0°</p> <p>Efficiency 95 %</p> <p>Peak intensity 13.6 cd/lm</p> <p>LEDs/each optic 1</p> <p>Light colour White</p> <p>Required components: F15255_HEKLA-SOCKET-C</p>		
<p></p> <p>LED Vesta DTW 9mm (4W/6W/12W)</p> <p>FWHM / FWTM 19.0° / 34.0°</p> <p>Efficiency 93 %</p> <p>Peak intensity 6.5 cd/lm</p> <p>LEDs/each optic 1</p> <p>Light colour White</p> <p>Required components: C16142_HEKLA-SOCKET-K Bender Wirth: 490 Typ L8</p>		

#### OPTICAL RESULTS (MEASURED):

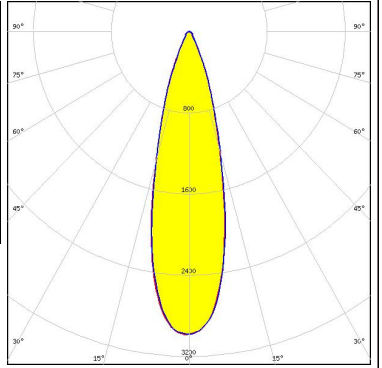
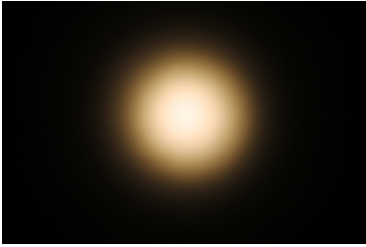
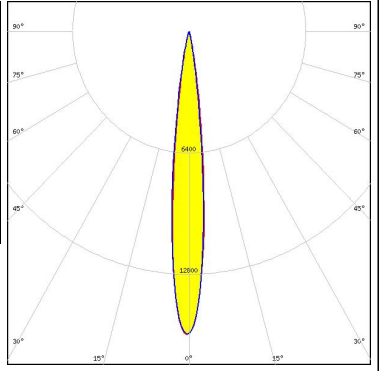
<p></p> <p>LED Vesta TW 6mm DP            FWHM / FWTM 14.0° / 25.0°            Efficiency 91 %            Peak intensity 12.2 cd/lm            LEDs/each optic 1            Light colour White            Required components:            C16142_HEKLA-SOCKET-K            Bender Wirth: 504 Typ L8</p>		
<p><b>CITIZEN</b></p> <p>LED CLU700/701/702/703            FWHM / FWTM 12.0° / 22.0°            Efficiency 96 %            Peak intensity 15.3 cd/lm            LEDs/each optic 1            Light colour White            Required components:            F15255_HEKLA-SOCKET-C</p>		
<p><b>CITIZEN</b></p> <p>LED CLU7A2/7A3            FWHM / FWTM 9.0° / 17.0°            Efficiency 94 %            Peak intensity 26 cd/lm            LEDs/each optic 1            Light colour White            Required components:            F15255_HEKLA-SOCKET-C</p>		
<p><b>CITIZEN</b></p> <p>LED CLU7B2            FWHM / FWTM 8.0° / 16.0°            Efficiency 94 %            Peak intensity 32.2 cd/lm            LEDs/each optic 1            Light colour White            Required components:            F15255_HEKLA-SOCKET-C</p>		

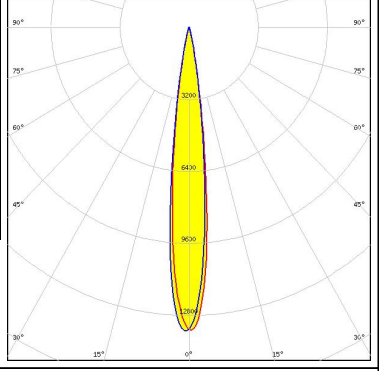
#### OPTICAL RESULTS (MEASURED):

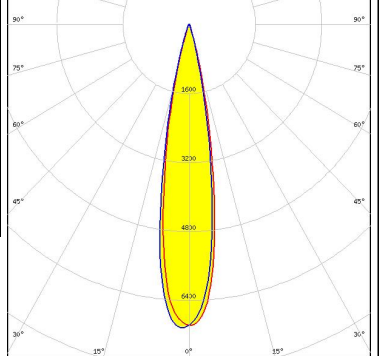
<p><b>LUMILEDS</b></p> <p>LED LUXEON CX Plus CoB L08 (Gen2)</p> <p>FWHM / FWTM 28.0° / 52.0°</p> <p>Efficiency 93 %</p> <p>Peak intensity 3 cd/lm</p> <p>LEDs/each optic 1</p> <p>Light colour White</p> <p>Required components: Bender Wirth: 637a Hekla</p>		
<p><b>LUMILEDS</b></p> <p>LED LUXEON CX Plus CoB - HD S01H4</p> <p>FWHM / FWTM 12.0° / 22.0°</p> <p>Efficiency 94 %</p> <p>Peak intensity 16 cd/lm</p> <p>LEDs/each optic 1</p> <p>Light colour White</p> <p>Required components: Bender Wirth: 634c Hekla</p>		
<p><b>LUMILEDS</b></p> <p>LED LUXEON CX Plus CoB - HD S02H6</p> <p>FWHM / FWTM 13.0° / 24.0°</p> <p>Efficiency 94 %</p> <p>Peak intensity 13.6 cd/lm</p> <p>LEDs/each optic 1</p> <p>Light colour White</p> <p>Required components: Bender Wirth: 634c Hekla</p>		
<p><b>LUMILEDS</b></p> <p>LED LUXEON CX Plus CoB - HD S04H9</p> <p>FWHM / FWTM 19.0° / 33.0°</p> <p>Efficiency 94 %</p> <p>Peak intensity 7 cd/lm</p> <p>LEDs/each optic 1</p> <p>Light colour White</p> <p>Required components: Bender Wirth: 634c Hekla</p>		

#### OPTICAL RESULTS (MEASURED):

##### LUMILEDS

LED LUXEON CX Plus CoB L04 / L05 (Gen2)  
 FWHM / FWTM 23.0° / 41.0°  
 Efficiency 93 %  
 Peak intensity 4.6 cd/lm  
 LEDs/each optic 1  
 Light colour White  
 Required components:  
 Bender Wirth: 637a Hekla

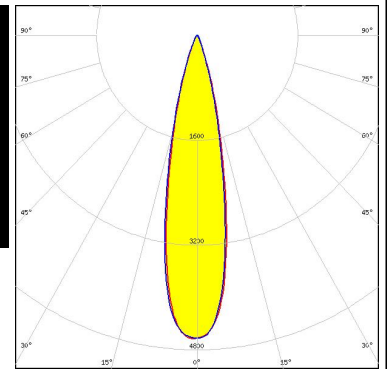
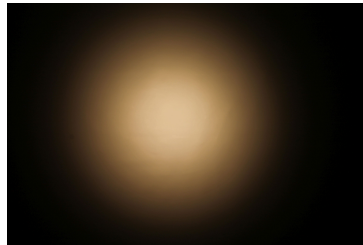

##### LUMILEDS

LED LUXEON CX Plus CoB M02 / M03 (Gen2)  
 FWHM / FWTM 17.0° / 32.0°  
 Efficiency 93 %  
 Peak intensity 7.9 cd/lm  
 LEDs/each optic 1  
 Light colour White  
 Required components:  
 Bender Wirth: 641a Hekla

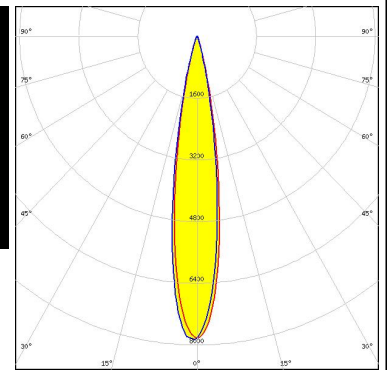

##### LUMILEDS

LED LUXEON CX Plus CoB S01 (Gen2)  
 FWHM / FWTM 12.0° / 23.0°  
 Efficiency 93 %  
 Peak intensity 14.5 cd/lm  
 LEDs/each optic 1  
 Light colour White  
 Required components:  
 Bender Wirth: 634c Hekla

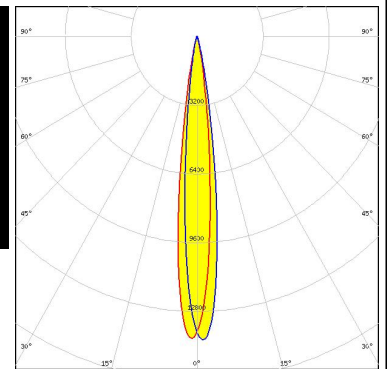
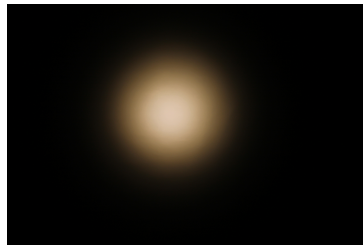



##### LUMINUS

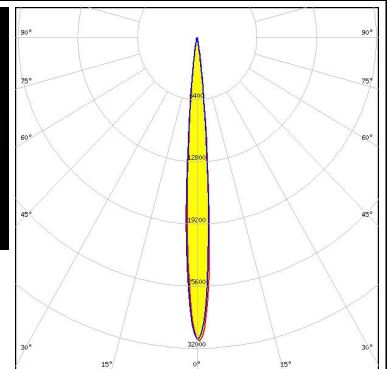
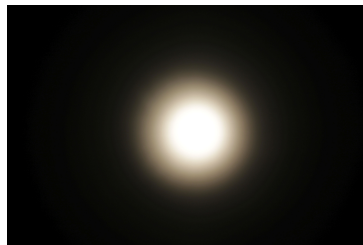

LED CXM-3  
 FWHM / FWTM 9.0° / 16.0°  
 Efficiency 94 %  
 Peak intensity 31.3 cd/lm  
 LEDs/each optic 1  
 Light colour White  
 Required components:  
 F15255\_HEKLA-SOCKET-C

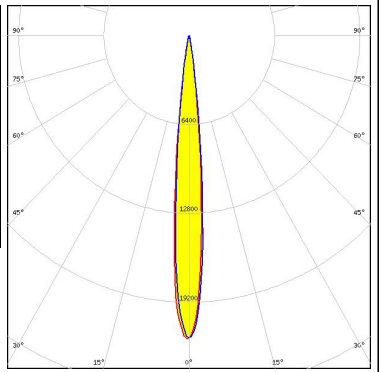
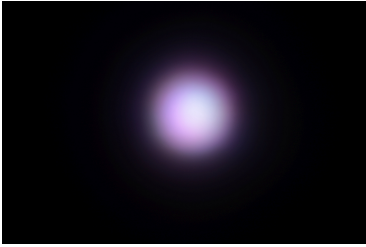
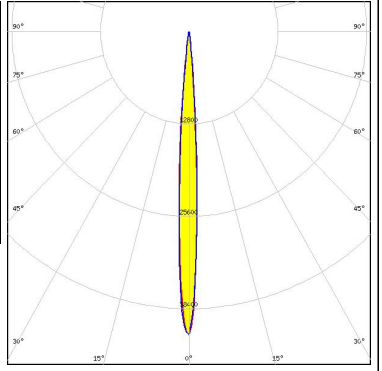

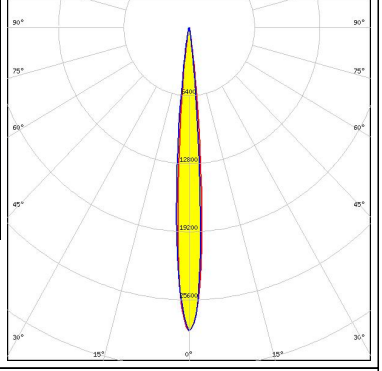
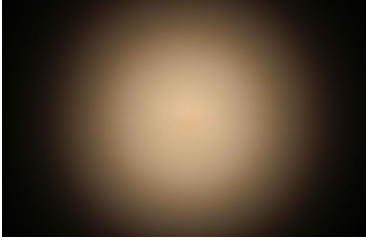
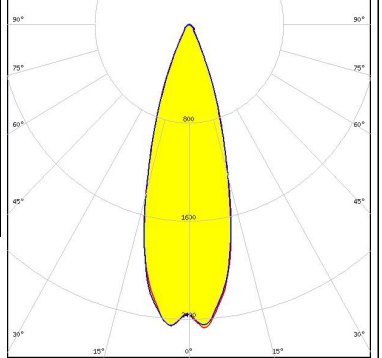
### OPTICAL RESULTS (MEASURED):

<p><b>LUMINUS</b></p> <p>LED CXM-4            FWHM / FWTM 10.0° / 19.0°            Efficiency 94 %            Peak intensity 21.9 cd/lm            LEDs/each optic 1            Light colour White            Required components:            F15255_HEKLA-SOCKET-C</p>		
<p><b>OSRAM</b> Opto Semiconductors</p> <p>LED OSTAR Stage (S2WN)            FWHM / FWTM 7.0° / 13.0°            Efficiency 94 %            Peak intensity 42.7 cd/lm            LEDs/each optic 1            Light colour White            Required components:            F15859_HEKLA-SOCKET-I</p>		
<p><b>OSRAM</b> Opto Semiconductors</p> <p>LED OSTAR Stage (S2WP)            FWHM / FWTM 9.0° / 16.0°            Efficiency 94 %            Peak intensity 29.2 cd/lm            LEDs/each optic 1            Light colour White            Required components:            F15859_HEKLA-SOCKET-I</p>		
<p><b>SEOUL SEMICONDUCTOR</b></p> <p>LED MJT COB LES 14.5            FWHM / FWTM 31.0° / 55.0°            Efficiency 94 %            Peak intensity 2.5 cd/lm            LEDs/each optic 1            Light colour White            Required components:            F17438_HEKLA-G2-I</p>		

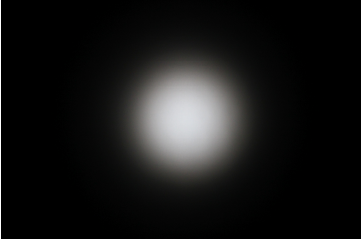
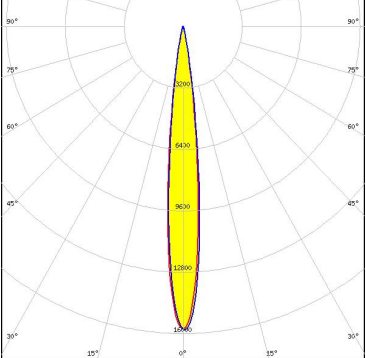
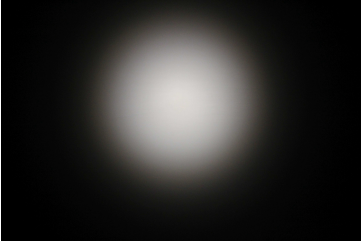
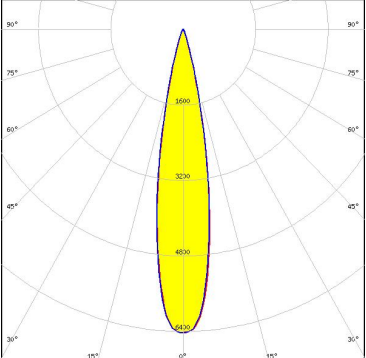
### OPTICAL RESULTS (MEASURED):

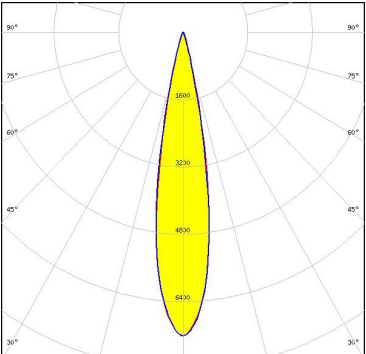
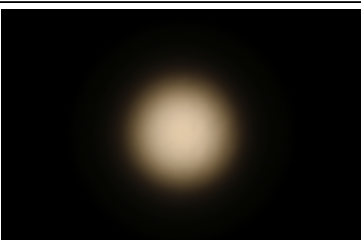
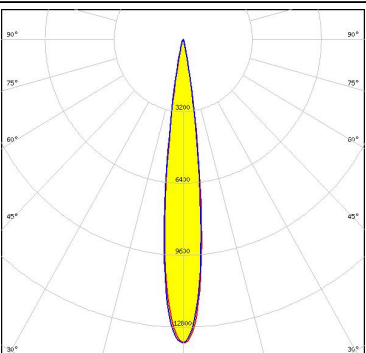
<p><b>SEOL</b> SEOUL SEMICONDUCTOR</p> <p>LED MJT COB LES 6 FWHM / FWTM 12.0° / 22.0° Efficiency 95 % Peak intensity 15.8 cd/lm LEDs/each optic 1 Light colour White Required components: F17435_HEKLA-G2-C</p>		
<p><b>SEOL</b> SEOUL SEMICONDUCTOR</p> <p>LED MJT COB LES 9.8 FWHM / FWTM 20.0° / 34.0° Efficiency 95 % Peak intensity 6.4 cd/lm LEDs/each optic 1 Light colour White Required components: F17435_HEKLA-G2-C</p>		
<p><b>TRIDONIC</b></p> <p>LED SLE G7 LES09 FWHM / FWTM 20.0° / 32.0° Efficiency 95 % Peak intensity 7.2 cd/lm LEDs/each optic 1 Light colour White Required components: F15255_HEKLA-SOCKET-C</p>		
<p><b>XICATO</b></p> <p>LED XOB 6 mm FWHM / FWTM 14.0° / 23.0° Efficiency 93 % Peak intensity 13.5 cd/lm LEDs/each optic 1 Light colour White Required components: F15255_HEKLA-SOCKET-C</p>		







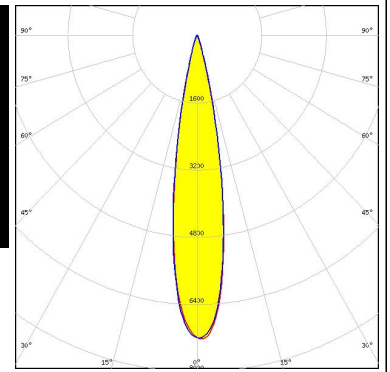

### OPTICAL RESULTS (MEASURED):

#### XICATO

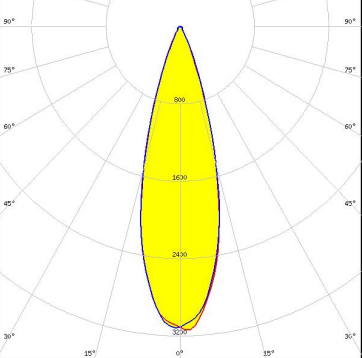
LED	XOB 9.8 mm
FWHM / FWTM	19.0° / 32.0°
Efficiency	94 %
Peak intensity	7.2 cd/lm
LEDs/each optic	1
Light colour	White
Required components:	
	F15255_HEKLA-SOCKET-C

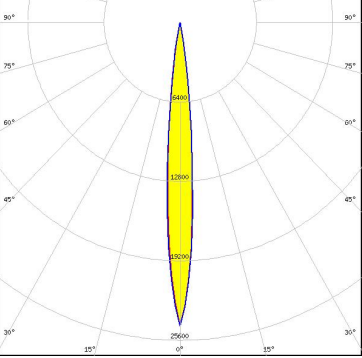

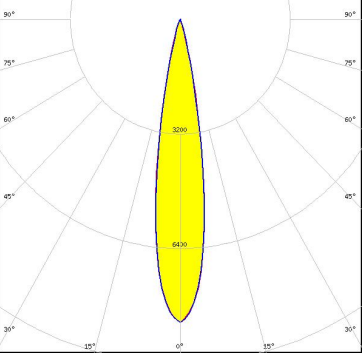
#### OPTICAL RESULTS (SIMULATED):

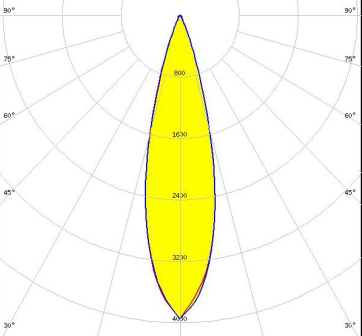
<p></p> <p>LED V13 Gen 8            FWHM / FWTM 30.0° / 50.0°            Efficiency 93 %            Peak intensity 3.1 cd/lm            LEDs/each optic 1            Light colour White            Required components:            F15859_HEKLA-SOCKET-I</p>	
<p></p> <p>LED V4 HD Gen 7            FWHM / FWTM 10.0° / 20.0°            Efficiency 95 %            Peak intensity 24.4 cd/lm            LEDs/each optic 1            Light colour White            Required components:            F15253_HEKLA-SOCKET-A</p>	
<p></p> <p>LED V9 HD Gen7            FWHM / FWTM 18.0° / 30.0°            Efficiency 94 %            Peak intensity 8.5 cd/lm            LEDs/each optic 1            Light colour White            Required components:            F15859_HEKLA-SOCKET-I</p>	
<p></p> <p>LED Vero SE 10            FWHM / FWTM 16.0° / 34.0°            Efficiency 94 %            Peak intensity 7.6 cd/lm            LEDs/each optic 1            Light colour White            Required components:</p>	

### OPTICAL RESULTS (SIMULATED):

#### CITIZEN

LED CLL02x/CLU02x (LES10)  
 FWHM / FWTM 18.0° / 33.0°  
 Efficiency 92 %  
 Peak intensity 7.8 cd/lm  
 LEDs/each optic 1  
 Light colour White  
 Required components:  
 F15255\_HEKLA-SOCKET-C

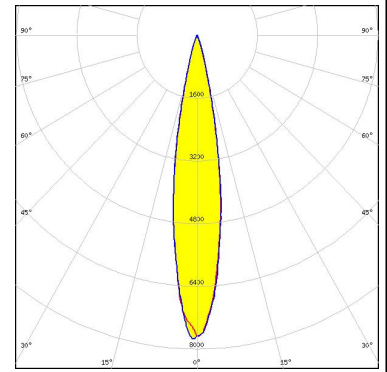

#### CITIZEN

LED CLU710/711  
 FWHM / FWTM 17.0° / 30.0°  
 Efficiency 92 %  
 Peak intensity 9.3 cd/lm  
 LEDs/each optic 1  
 Light colour White  
 Required components:  
 F15859\_HEKLA-SOCKET-I

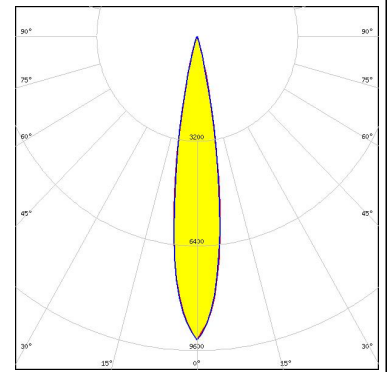

#### CITIZEN

LED CLU712/713  
 FWHM / FWTM 18.0° / 31.0°  
 Efficiency 94 %  
 Peak intensity 8.2 cd/lm  
 LEDs/each optic 1  
 Light colour White  
 Required components:  
 F17438\_HEKLA-G2-I

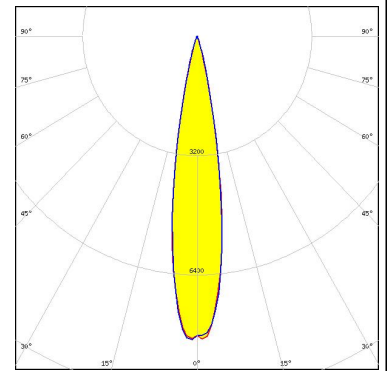

LED CHA0304  
 FWHM / FWTM 9.0° / 18.0°  
 Efficiency 95 %  
 Peak intensity 27.4 cd/lm  
 LEDs/each optic 1  
 Light colour White  
 Required components:  
 F17435\_HEKLA-G2-C

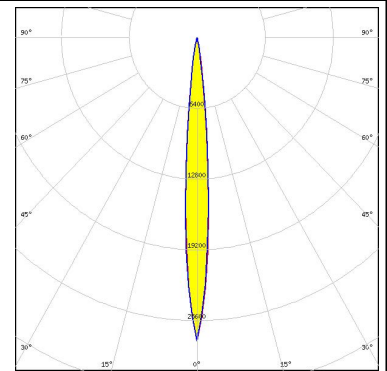

### OPTICAL RESULTS (SIMULATED):



LED CHA0410  
 FWHM / FWTM 10.0° / 20.0°  
 Efficiency 95 %  
 Peak intensity 21.8 cd/lm  
 LEDs/each optic 1  
 Light colour White  
 Required components:  
 F17435\_HEKLA-G2-C

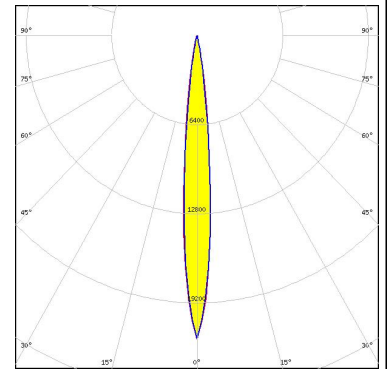

LED CMA1303  
 FWHM / FWTM 10.0° / 20.0°  
 Efficiency 95 %  
 Peak intensity 22.8 cd/lm  
 LEDs/each optic 1  
 Light colour White  
 Required components:  
 F17439\_HEKLA-G2-J

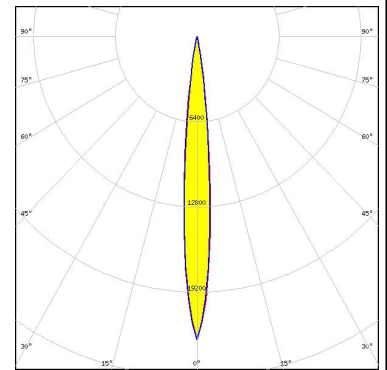

LED CMA1306  
 FWHM / FWTM 12.0° / 24.0°  
 Efficiency 95 %  
 Peak intensity 15.5 cd/lm  
 LEDs/each optic 1  
 Light colour White  
 Required components:  
 F15956\_HEKLA-SOCKET-J

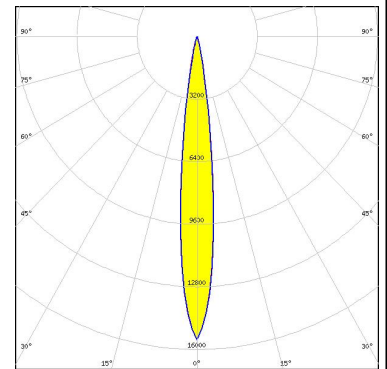

LED CXA/B 13xx  
 FWHM / FWTM 13.0° / 24.0°  
 Efficiency 93 %  
 Peak intensity 15 cd/lm  
 LEDs/each optic 1  
 Light colour White  
 Required components:  
 F15956\_HEKLA-SOCKET-J

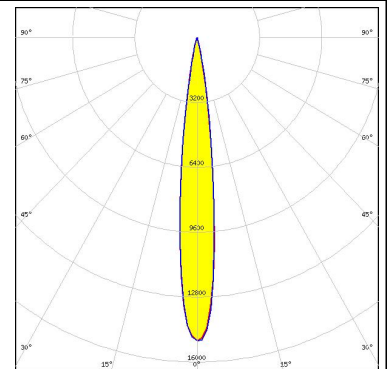

### OPTICAL RESULTS (SIMULATED):



LED CXA/B 15xx  
 FWHM / FWTM 20.0° / 32.0°  
 Efficiency 92 %  
 Peak intensity 7.4 cd/lm  
 LEDs/each optic 1  
 Light colour White  
 Required components:  
 F17436\_HEKLA-G2-D

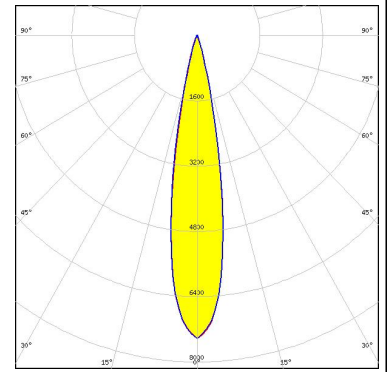

LED CXA/B 15xx  
 FWHM / FWTM 19.0° / 32.0°  
 Efficiency 93 %  
 Peak intensity 7.6 cd/lm  
 LEDs/each optic 1  
 Light colour White  
 Required components:  
 F15256\_HEKLA-SOCKET-D

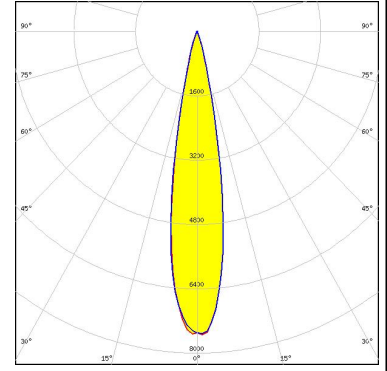

LED CXA/B 1816 & CXA/B 1820 & CXA 1850  
 FWHM / FWTM 23.0° / 40.0°  
 Efficiency 93 %  
 Peak intensity 4.4 cd/lm  
 LEDs/each optic 1  
 Light colour White  
 Required components:  
 F15254\_HEKLA-SOCKET-B

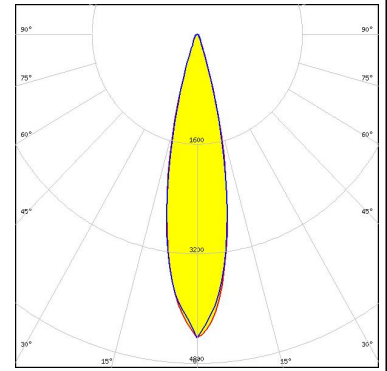

LED LUXEON CoB 1202/1203  
 FWHM / FWTM 18.0° / 33.0°  
 Efficiency 93 %  
 Peak intensity 7.4 cd/lm  
 LEDs/each optic 1  
 Light colour White  
 Required components:  
 F17437\_HEKLA-G2-H

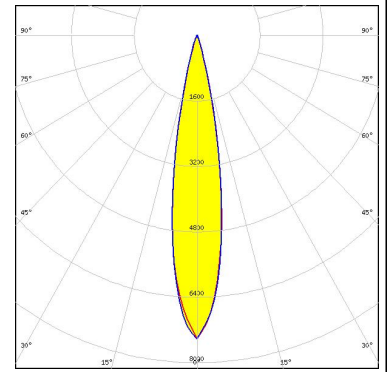

### OPTICAL RESULTS (SIMULATED):

<p><b>LUMILEDS</b></p> <p>LED LUXEON CoB 1202s</p> <p>FWHM / FWTM 12.0° / 24.0°</p> <p>Efficiency 95 %</p> <p>Peak intensity 15.6 cd/lm</p> <p>LEDs/each optic 1</p> <p>Light colour White</p> <p>Required components: F15858_HEKLA-SOCKET-H</p>	
<p><b>LUMILEDS</b></p> <p>LED LUXEON CoB 1204/1205</p> <p>FWHM / FWTM 26.0° / 44.0°</p> <p>Efficiency 94 %</p> <p>Peak intensity 3.9 cd/lm</p> <p>LEDs/each optic 1</p> <p>Light colour White</p> <p>Required components:</p>	
<p><b>LUMILEDS</b></p> <p>LED LUXEON CoB 1204HD</p> <p>FWHM / FWTM 20.0° / 32.0°</p> <p>Efficiency 94 %</p> <p>Peak intensity 7.7 cd/lm</p> <p>LEDs/each optic 1</p> <p>Light colour White</p> <p>Required components: F17437_HEKLA-G2-H</p>	
<p><b>LUMILEDS</b></p> <p>LED LUXEON CoB 1205HD</p> <p>FWHM / FWTM 24.0° / 39.0°</p> <p>Efficiency 94 %</p> <p>Peak intensity 5 cd/lm</p> <p>LEDs/each optic 1</p> <p>Light colour White</p> <p>Required components: F17437_HEKLA-G2-H</p>	

### OPTICAL RESULTS (SIMULATED):

<p><b>LUMILEDS</b></p> <p>LED: LUXEON CoB 1208            FWHM / FWTM: 27.0° / 50.0°            Efficiency: 91 %            Peak intensity: 3.2 cd/lm            LEDs/each optic: 1            Light colour: White            Required components:            C16142_HEKLA-SOCKET-K</p>	
<p><b>LUMINUS</b></p> <p>LED: CxM-6 (13.5x13.5)            FWHM / FWTM: 14.0° / 25.0°            Efficiency: 94 %            Peak intensity: 13.4 cd/lm            LEDs/each optic: 1            Light colour: White            Required components:            F15255_HEKLA-SOCKET-C</p>	
<p><b>NICHIA</b></p> <p>LED: COB S-Type (LES 6)            FWHM / FWTM: 12.0° / 24.0°            Efficiency: 93 %            Peak intensity: 15.4 cd/lm            LEDs/each optic: 1            Light colour: White            Required components:            F15848_HEKLA-SOCKET-G</p>	
<p><b>NICHIA</b></p> <p>LED: COB S-Type (LES 6)            FWHM / FWTM: 12.0° / 24.0°            Efficiency: 93 %            Peak intensity: 15.6 cd/lm            LEDs/each optic: 1            Light colour: White            Required components:            F15848_HEKLA-SOCKET-G</p>	

### OPTICAL RESULTS (SIMULATED):

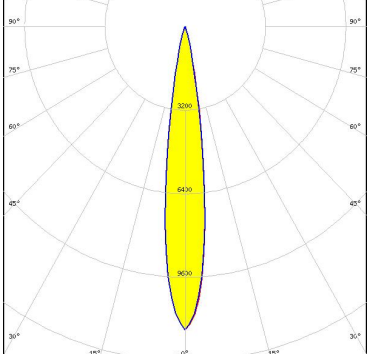
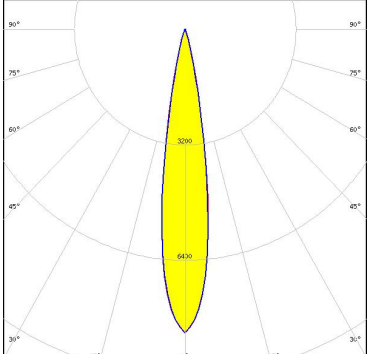
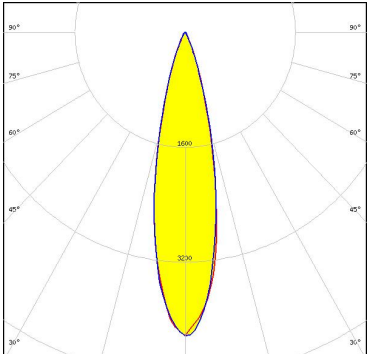
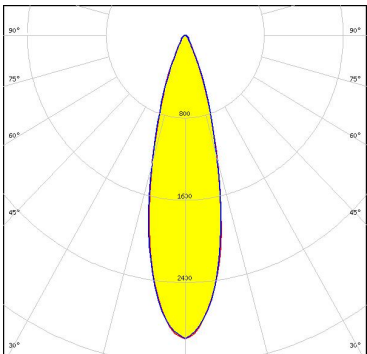
<p><b>NICHIA</b></p> <p>LED COB S-Type (LES 7)</p> <p>FWHM / FWTM 16.0° / 26.0°</p> <p>Efficiency 95 %</p> <p>Peak intensity 11.6 cd/lm</p> <p>LEDs/each optic 1</p> <p>Light colour White</p> <p>Required components: F15848_HEKLA-SOCKET-G</p>	
<p><b>NICHIA</b></p> <p>LED NFSWE11A</p> <p>FWHM / FWTM 18.0° / 30.0°</p> <p>Efficiency 88 %</p> <p>Peak intensity 8.4 cd/lm</p> <p>LEDs/each optic 30</p> <p>Light colour White</p> <p>Required components: C16142_HEKLA-SOCKET-K</p>	
<p><b>PHILIPS</b></p> <p>LED Fortimo SLM L13 CoB</p> <p>FWHM / FWTM 24.0° / 44.0°</p> <p>Efficiency 93 %</p> <p>Peak intensity 4.2 cd/lm</p> <p>LEDs/each optic 1</p> <p>Light colour White</p> <p>Required components: Bender Wirth: 632a Hekla XL</p>	
<p><b>PHILIPS</b></p> <p>LED Fortimo SLM L15 CoB</p> <p>FWHM / FWTM 28.0° / 52.0°</p> <p>Efficiency 92 %</p> <p>Peak intensity 3 cd/lm</p> <p>LEDs/each optic 1</p> <p>Light colour White</p> <p>Required components: Bender Wirth: 632a Hekla XL</p>	



#### OPTICAL RESULTS (SIMULATED):

### PHILIPS

LED Fortimo SLM L15 CoB  
 FWHM / FWTM 26.0° / 50.0°  
 Efficiency 93 %  
 Peak intensity 3.3 cd/lm  
 LEDs/each optic 1  
 Light colour White  
 Required components:  
 Bender Wirth: 632a Hekla XL

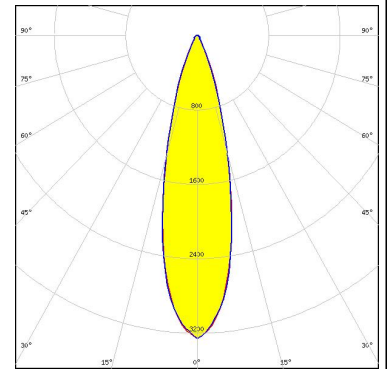

### SAMSUNG

LED LC010C  
 FWHM / FWTM 14.0° / 24.0°  
 Efficiency 94 %  
 Peak intensity 14.4 cd/lm  
 LEDs/each optic 1  
 Light colour White  
 Required components:  
 F15848\_HEKLA-SOCKET-G

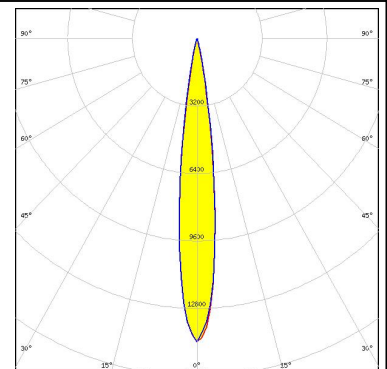

### SAMSUNG

LED LC020C  
 FWHM / FWTM 14.0° / 24.0°  
 Efficiency 94 %  
 Peak intensity 13.5 cd/lm  
 LEDs/each optic 1  
 Light colour White  
 Required components:  
 F17438\_HEKLA-G2-I

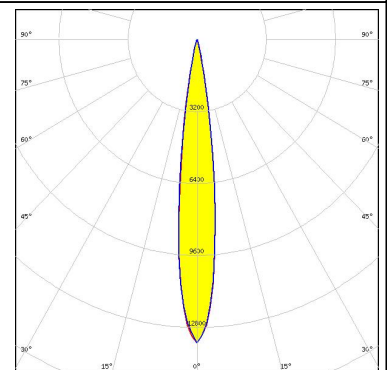

### XICATO

LED XTM - 9mm LES  
 FWHM / FWTM 18.0° / 32.0°  
 Efficiency 94 %  
 Peak intensity 8.3 cd/lm  
 LEDs/each optic 1  
 Light colour White  
 Required components:  
 C15743\_XTM-ADAPTER-50-B

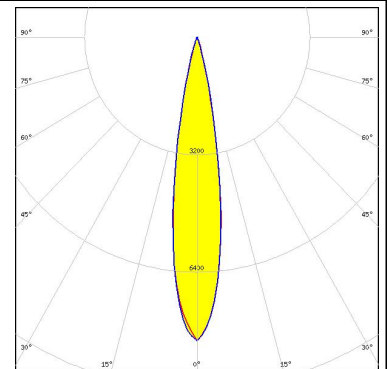

### GENERAL INFORMATION:

NOTE: The typical beam angle will be changed by different color, chip size and chip position tolerance. The typical total beam angle is the full angle measured where the luminous intensity is half of the peak value.

Due to use of high power COB's with this product, special attention to proper thermal design is highly recommended. LEDiL has no liability for direct, indirect or consecutive damages arising from the LEDiL products being used outside of the recommended temperature range.

### MATERIALS:

As part of our continuous research and improvement processes, and to ensure the best possible quality and availability of our products, LEDiL reserves the right to change material grades without notice.

### PRODUCT DATA USER AGREEMENT AND DISCLAIMER:

The measured data in the provided downloadable LEDiL Product Datasheets and Mechanical 2D-Drawings is rounded and provided as reference for planning. LEDiL Oy's optical specifications have been verified by conducting performance testing of the products in accordance with the company's quality system. The reported data are averaged results of multiple measurements with typical variation. LEDiL Oy reserves the right to without prior notification make changes and improvements to its products.

LEDiL Oy assumes neither warranty, nor guarantee nor any other liability of any kind for the contents and correctness of the provided data. The provided data has been generated with highest diligence but the provided data may in reality not represent the complete possible variation range of all intrinsic parameters. Therefore, in certain cases a deviation from the provided data could occur.

LEDiL Oy reserves the right to undertake technical changes of its products without further notification which could lead to changes in the provided data. LEDiL Oy assumes no liability of any kind for the possible deviation from any provided data or any other damage resulting from the usage of the provided data.

The user agrees to this disclaimer and user agreement with the download or usage of the provided files.

#### LEDiL Oy

Joensuunkatu 13  
FI-24240 SALO  
Finland

#### LEDiL Inc.

228 West Page Street  
Suite D  
Sycamore IL 60178  
USA

#### Ledil Optics Technology (Shenzhen) Co., Ltd.

# 405 , Block B  
Casic Motor Building  
Shenzhen 518057  
P.R.CHINA

#### Local sales and technical support

[www.ledil.com/  
where\\_to\\_buy](http://www.ledil.com/where_to_buy)

#### Shipping locations

Salo, Finland  
Hong Kong, China

#### Distribution Partners

[www.ledil.com/  
where\\_to\\_buy](http://www.ledil.com/where_to_buy)