

## CARMEN-50-W-C-WHT

~50° spot beam. Assembly with holder C compatible with LEDiL HEKLA. White version.

### SPECIFICATION:

Dimensions	50.0 x 50.0 mm
Height	25.5 mm
Fastening	socket
ROHS compliant	yes ⓘ

### MATERIALS:

Component	Type	Material	Colour	Finish
CARMEN-50-W	Single lens	PMMA	clear	
CARMEN-50-HLD-C-WHT	Holder	PC	white	

### ORDERING INFORMATION:





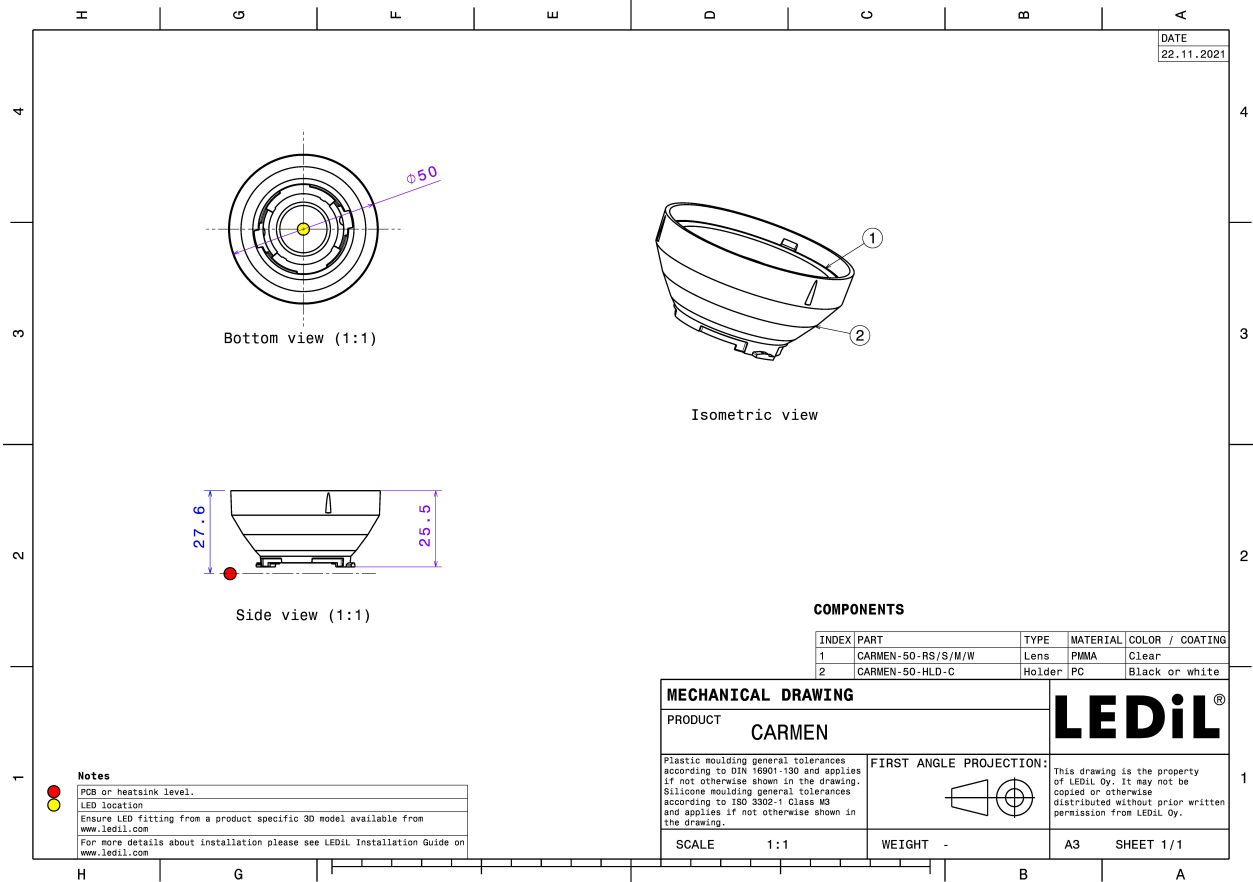

Component	Type	Qty in box	MOQ	MPQ	Box weight (kg)
CP16635_CARMEN-50-W-C-WHT » Box size: 476 x 273 x 292 mm	Single lens	308	112	28	5.7



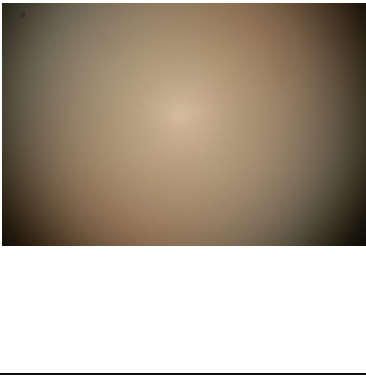
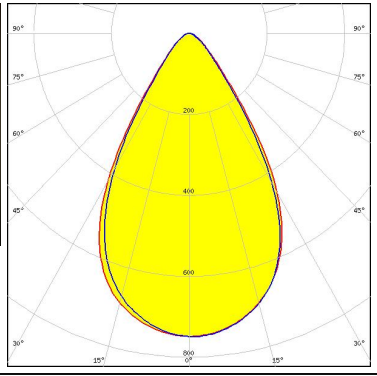

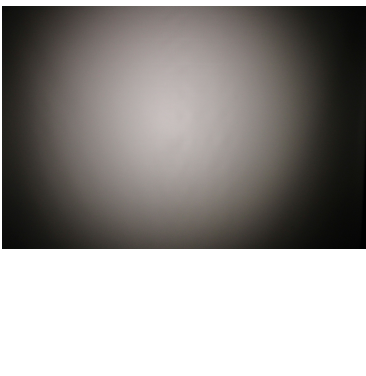
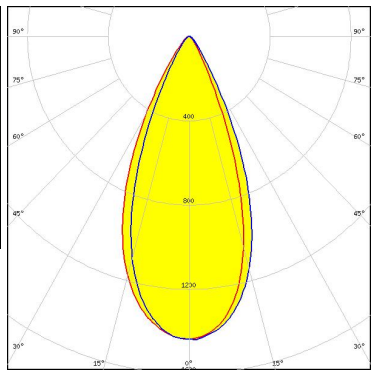
See also our general installation guide: [www.ledil.com/installation\\_guide](http://www.ledil.com/installation_guide)

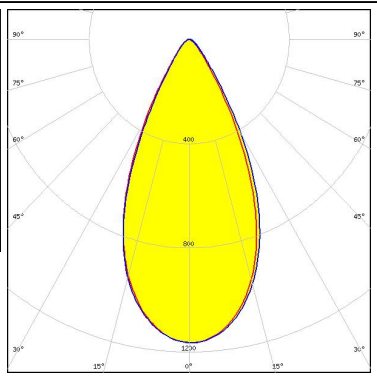
#### OPTICAL RESULTS (MEASURED):

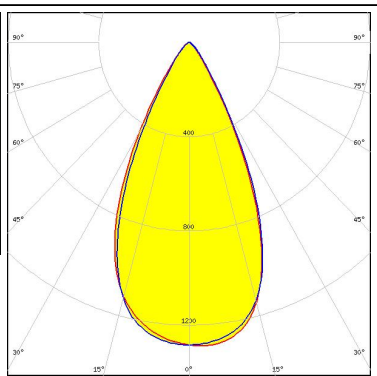
<p></p> <p>LED Vesta DTW 13mm (21W)            FWHM / FWTM 63.0° / 94.0°            Efficiency 82 %            Peak intensity 0.8 cd/m            LEDs/each optic 1            Light colour White            Required components:            C16142_HEKLA-SOCKET-K            Bender Wirth: 491 Typ L8</p>		
<p></p> <p>LED Vesta TW 6mm DP            FWHM / FWTM 45.0° / 69.0°            Efficiency 86 %            Peak intensity 1.4 cd/m            LEDs/each optic 1            Light colour White            Required components:            C16142_HEKLA-SOCKET-K            Bender Wirth: 504 Typ L8</p>		
<p></p> <p>LED Vesta TW 9mm (9W) DP            FWHM / FWTM 49.0° / 76.0°            Efficiency 85 %            Peak intensity 1.2 cd/m            LEDs/each optic 1            Light colour White            Required components:            C16142_HEKLA-SOCKET-K            Bender Wirth: 489 Typ L8</p>		
<p><b>CITIZEN</b></p> <p>LED CLU700/701/702/703            FWHM / FWTM 51.0° / 75.0°            Efficiency 93 %            Peak intensity 1.3 cd/m            LEDs/each optic 1            Light colour White            Required components:            F15255_HEKLA-SOCKET-C</p>		

#### OPTICAL RESULTS (MEASURED):

#### CITIZEN

LED CLU710/711  
 FWHM / FWTM 54.0° / 79.0°  
 Efficiency 90 %  
 Peak intensity 1.2 cd/lm  
 LEDs/each optic 1  
 Light colour White  
 Required components:  
 F15859\_HEKLA-SOCKET-I

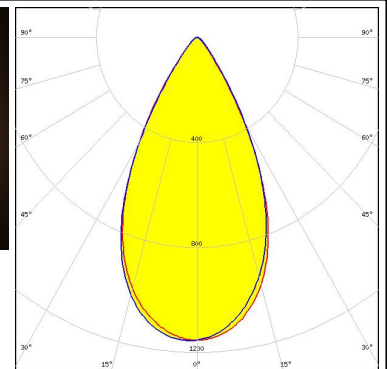
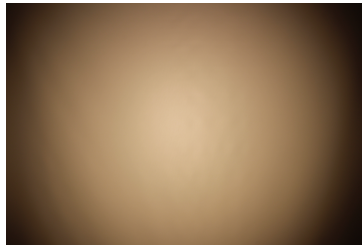

#### CITIZEN

LED CLU7B2  
 FWHM / FWTM 53.0° / 74.0°  
 Efficiency 94 %  
 Peak intensity 1.2 cd/lm  
 LEDs/each optic 1  
 Light colour White  
 Required components:  
 F15255\_HEKLA-SOCKET-C

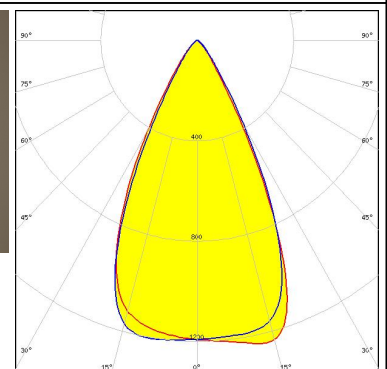
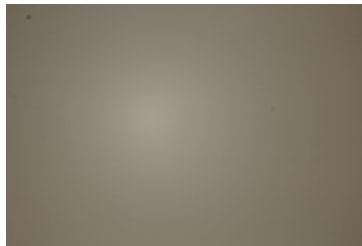

#### CREE LEDs

LED CXA/B 13xx  
 FWHM / FWTM 54.0° / 77.0°  
 Efficiency 93 %  
 Peak intensity 1.2 cd/lm  
 LEDs/each optic 1  
 Light colour White  
 Required components:  
 F15956\_HEKLA-SOCKET-J

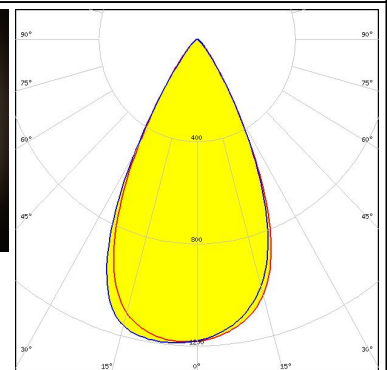
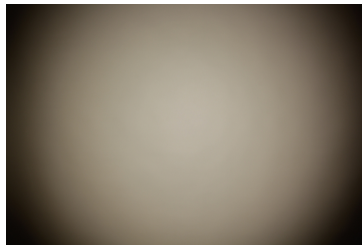

#### LUMILEDS

LED LUXEON CX Plus CoB - HD S01H4  
 FWHM / FWTM 48.0° / 74.0°  
 Efficiency 90 %  
 Peak intensity 1.3 cd/lm  
 LEDs/each optic 1  
 Light colour White  
 Required components:  
 Bender Wirth: 634c Hekla

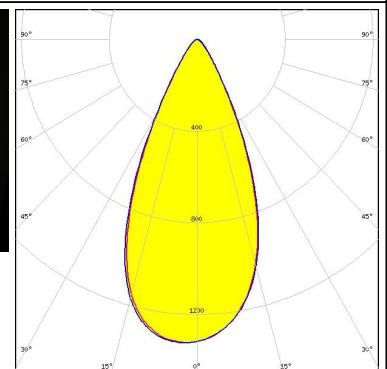
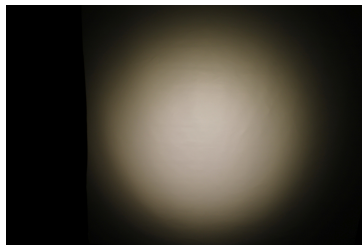

#### OPTICAL RESULTS (MEASURED):

#### LUMILEDS

LED LUXEON CX Plus CoB - HD S02H6  
 FWHM / FWTM 47.0° / 74.0°  
 Efficiency 90 %  
 Peak intensity 1.3 cd/lm  
 LEDs/each optic 1  
 Light colour White  
 Required components:  
 Bender Wirth: 634c Hekla

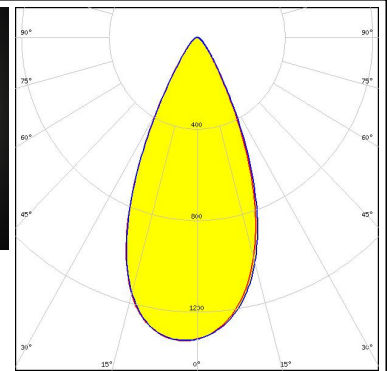
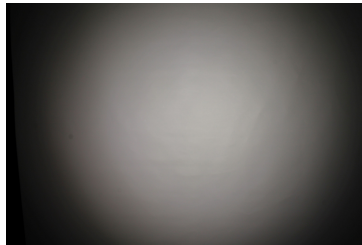

#### LUMILEDS

LED LUXEON CX Plus CoB - HD S04H9  
 FWHM / FWTM 51.0° / 80.0°  
 Efficiency 89 %  
 Peak intensity 1.2 cd/lm  
 LEDs/each optic 1  
 Light colour White  
 Required components:  
 Bender Wirth: 634c Hekla

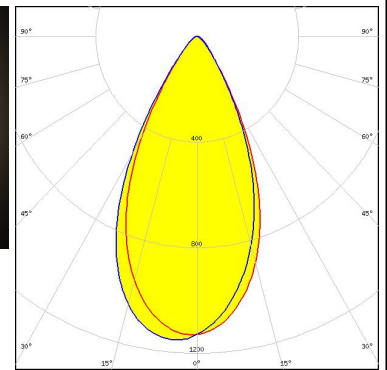
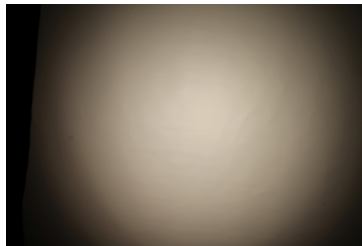

#### LUMILEDS

LED LUXEON CX Plus CoB M02 / M03 (Gen2)  
 FWHM / FWTM 48.0° / 72.0°  
 Efficiency 75 %  
 Peak intensity 1.2 cd/lm  
 LEDs/each optic 1  
 Light colour White  
 Required components:  
 Bender Wirth: 641a Hekla

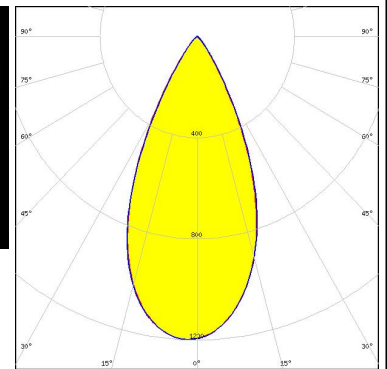
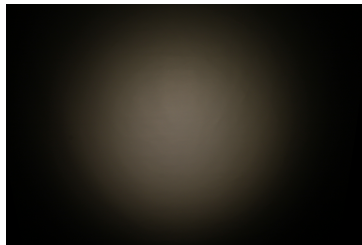

#### LUMILEDS

LED LUXEON CX Plus CoB S01 (Gen2)  
 FWHM / FWTM 47.0° / 73.0°  
 Efficiency 90 %  
 Peak intensity 1.4 cd/lm  
 LEDs/each optic 1  
 Light colour White  
 Required components:  
 Bender Wirth: 634c Hekla

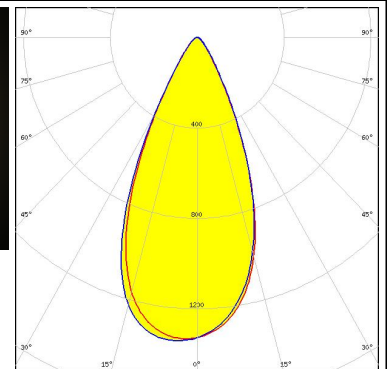
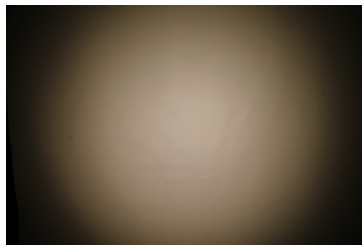

#### OPTICAL RESULTS (MEASURED):



**LED** CXM-3  
**FWHM / FWTM** 53.0° / 74.0°  
**Efficiency** 96 %  
**Peak intensity** 1.3 cd/lm  
**LEDs/each optic** 1  
**Light colour** White  
**Required components:**  
 F15255\_HEKLA-SOCKET-C

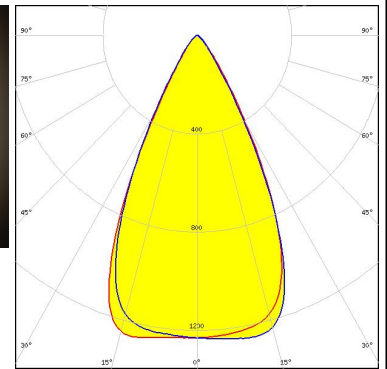

**LED** CXM-4  
**FWHM / FWTM** 52.0° / 74.0°  
**Efficiency** 92 %  
**Peak intensity** 1.2 cd/lm  
**LEDs/each optic** 1  
**Light colour** White  
**Required components:**  
 F15255\_HEKLA-SOCKET-C

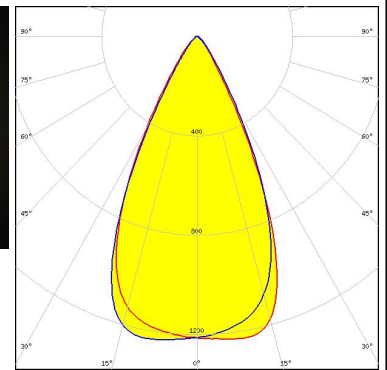
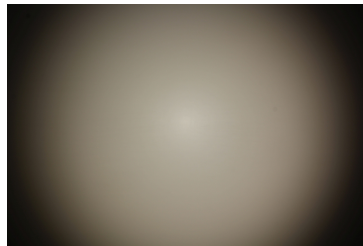

**LED** LC010T (Tunable White)  
**FWHM / FWTM** 49.0° / 76.0°  
**Efficiency** 84 %  
**Peak intensity** 1.2 cd/lm  
**LEDs/each optic** 1  
**Light colour** Tunable White  
**Required components:**  
 C16142\_HEKLA-SOCKET-K  
 Bender Wirth: 501 Typ L8

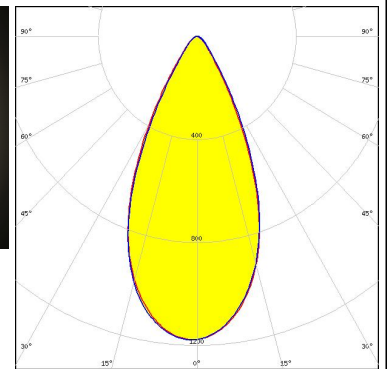
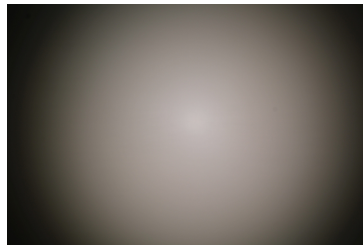

**LED** XOB 6 mm  
**FWHM / FWTM** 52.0° / 76.0°  
**Efficiency** 90 %  
**Peak intensity** 1.2 cd/lm  
**LEDs/each optic** 1  
**Light colour** White  
**Required components:**  
 F15255\_HEKLA-SOCKET-C

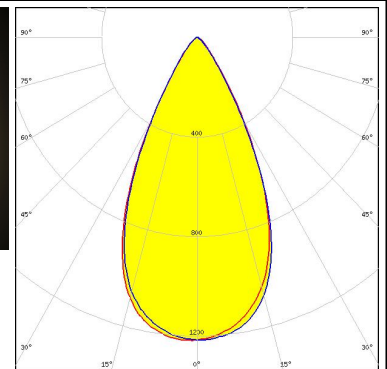
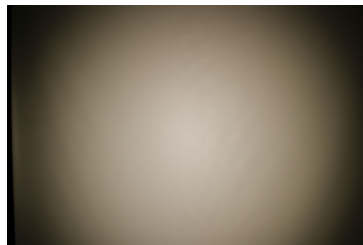

#### OPTICAL RESULTS (MEASURED):

#### XICATO

LED	XOB 9.8 mm
FWHM / FWTM	54.0° / 82.0°
Efficiency	89 %
Peak intensity	1.1 cd/lm
LEDs/each optic	1
Light colour	White
Required components:	
	F15255_HEKLA-SOCKET-C

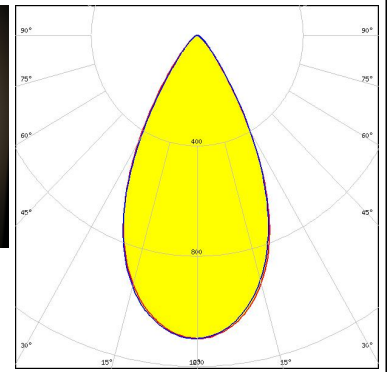

#### OPTICAL RESULTS (SIMULATED):



**LED** CMU15xx  
**FWHM / FWTM** 67.0° / 91.0°  
**Efficiency** 88 %  
**Peak intensity** 0.8 cd/lm  
**LEDs/each optic** 1  
**Light colour** White  
**Required components:**  
 F17438\_HEKLA-G2-I

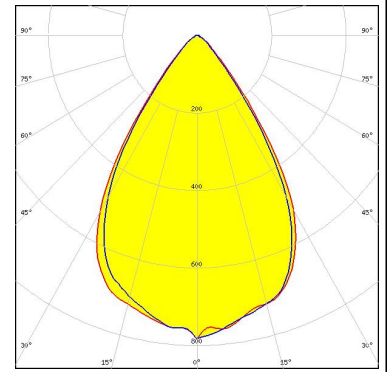

**LED** CMU15xx  
**FWHM / FWTM** 68.0° / 92.0°  
**Efficiency** 88 %  
**Peak intensity** 0.8 cd/lm  
**LEDs/each optic** 1  
**Light colour** White  
**Required components:**  
 F17438\_HEKLA-G2-I

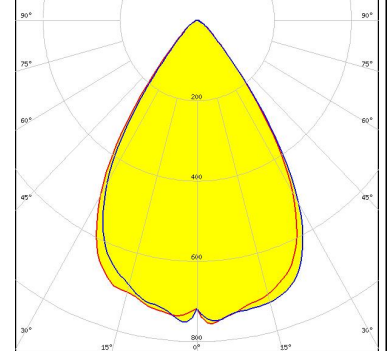

**LED** MJT COB LES 6  
**FWHM / FWTM** 54.0° / 71.0°  
**Efficiency** 93 %  
**Peak intensity** 1.3 cd/lm  
**LEDs/each optic** 1  
**Light colour** White  
**Required components:**  
 F15255\_HEKLA-SOCKET-C

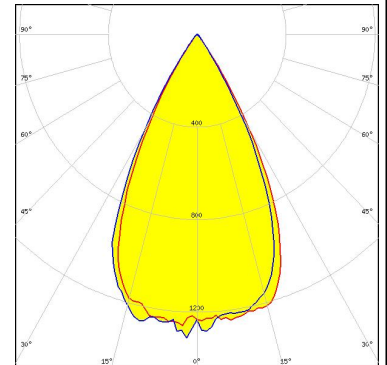

**LED** MJT COB LES 9.8  
**FWHM / FWTM** 53.0° / 77.0°  
**Efficiency** 91 %  
**Peak intensity** 1.3 cd/lm  
**LEDs/each optic** 1  
**Light colour** White  
**Required components:**  
 F15255\_HEKLA-SOCKET-C

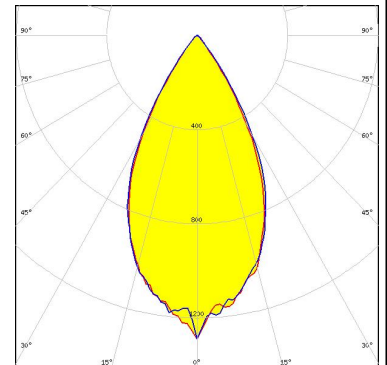



### GENERAL INFORMATION:

NOTE: The typical beam angle will be changed by different color, chip size and chip position tolerance. The typical total beam angle is the full angle measured where the luminous intensity is half of the peak value.

Due to use of high power COB's with this product, special attention to proper thermal design is highly recommended. LEDiL has no liability for direct, indirect or consecutive damages arising from the LEDiL products being used outside of the recommended temperature range.

### MATERIALS:

As part of our continuous research and improvement processes, and to ensure the best possible quality and availability of our products, LEDiL reserves the right to change material grades without notice.

### PRODUCT DATA USER AGREEMENT AND DISCLAIMER:

The measured data in the provided downloadable LEDiL Product Datasheets and Mechanical 2D-Drawings is rounded and provided as reference for planning. LEDiL Oy's optical specifications have been verified by conducting performance testing of the products in accordance with the company's quality system. The reported data are averaged results of multiple measurements with typical variation. LEDiL Oy reserves the right to without prior notification make changes and improvements to its products.

LEDiL Oy assumes neither warranty, nor guarantee nor any other liability of any kind for the contents and correctness of the provided data. The provided data has been generated with highest diligence but the provided data may in reality not represent the complete possible variation range of all intrinsic parameters. Therefore, in certain cases a deviation from the provided data could occur.

LEDiL Oy reserves the right to undertake technical changes of its products without further notification which could lead to changes in the provided data. LEDiL Oy assumes no liability of any kind for the possible deviation from any provided data or any other damage resulting from the usage of the provided data.

The user agrees to this disclaimer and user agreement with the download or usage of the provided files.

#### LEDiL Oy

Joensuunkatu 13  
FI-24240 SALO  
Finland

#### LEDiL Inc.

228 West Page Street  
Suite D  
Sycamore IL 60178  
USA

#### Ledil Optics Technology (Shenzhen) Co., Ltd.

# 405 , Block B  
Casic Motor Building  
Shenzhen 518057  
P.R.CHINA

#### Local sales and technical support

[www.ledil.com/  
where\\_to\\_buy](http://www.ledil.com/where_to_buy)

#### Shipping locations

Salo, Finland  
Hong Kong, China

#### Distribution Partners

[www.ledil.com/  
where\\_to\\_buy](http://www.ledil.com/where_to_buy)