

## LISA3CSP-W-PIN

~35° wide beam

### SPECIFICATION:

Dimensions	Ø 10.0 mm
Height	7.2 mm
Fastening	pin
ROHS compliant	yes ⓘ

### MATERIALS:

Component	Type	Material	Colour	Finish
LISA3-W	Single lens	PMMA	clear	
LISA3-HLD2-PIN	Holder	PC	black	

### ORDERING INFORMATION:





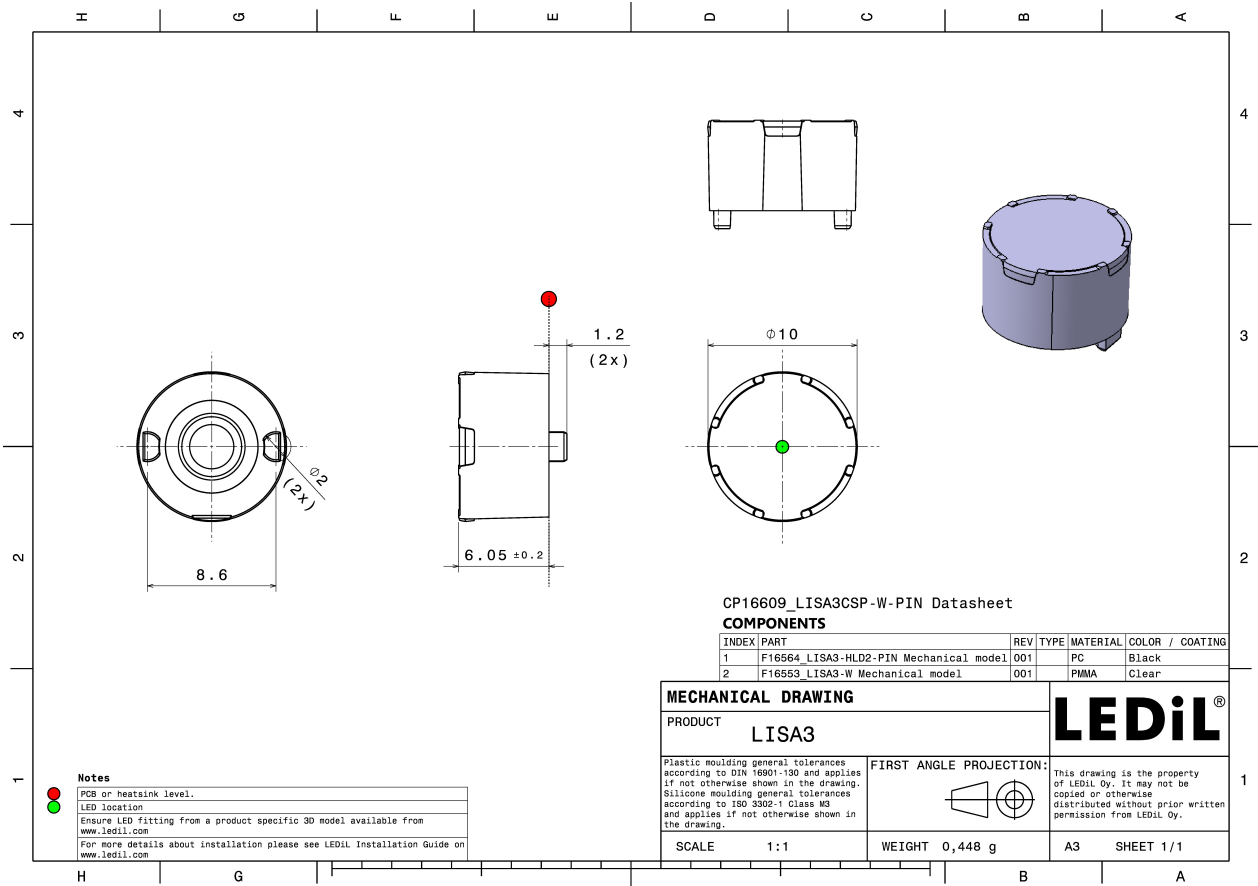



Component		Qty in box	MOQ	MPQ	Box weight (kg)
FP16609_LISA3CSP-W-PIN	Single lens	2000	300	100	1.3
» Box size: 310 x 230 x 60 mm					



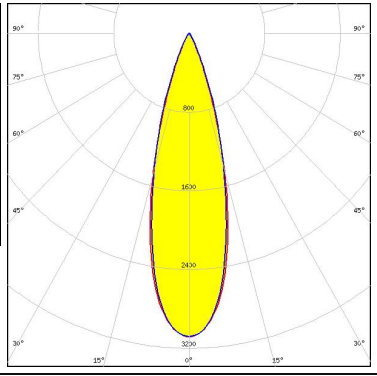

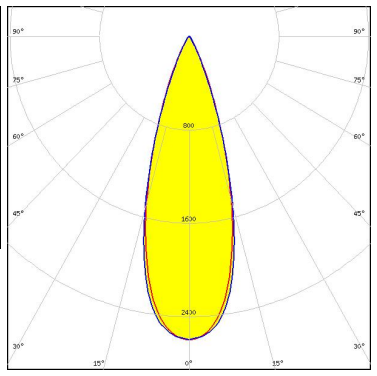
See also our general installation guide: [www.ledil.com/installation\\_guide](http://www.ledil.com/installation_guide)

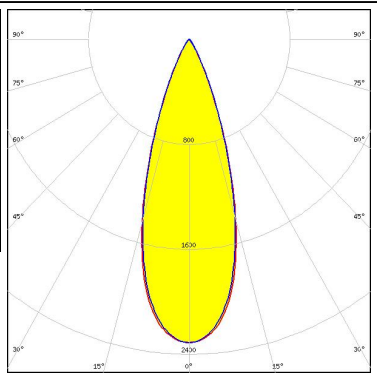
#### OPTICAL RESULTS (MEASURED):

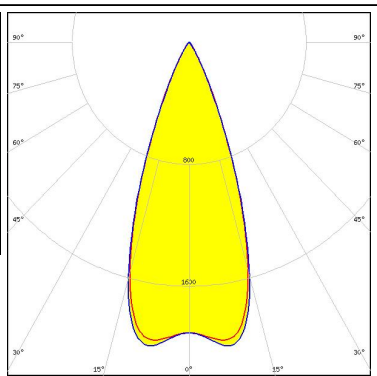
<p></p> <p>LED CSP 1111 (BXCP)</p> <p>FWHM / FWTM 29.0° / 49.0°</p> <p>Efficiency 86 %</p> <p>Peak intensity 3.1 cd/m</p> <p>LEDs/each optic 1</p> <p>Light colour White</p> <p>Required components:</p>		
<p></p> <p>LED CSP 1919 (BXCP)</p> <p>FWHM / FWTM 33.0° / 53.0°</p> <p>Efficiency 88 %</p> <p>Peak intensity 2.7 cd/m</p> <p>LEDs/each optic 1</p> <p>Light colour White</p> <p>Required components:</p>		
<p></p> <p>LED CSP 2323 (BXCP)</p> <p>FWHM / FWTM 35.0° / 56.0°</p> <p>Efficiency 88 %</p> <p>Peak intensity 2.3 cd/m</p> <p>LEDs/each optic 1</p> <p>Light colour White</p> <p>Required components:</p>		
<p></p> <p>LED NCSxE17A</p> <p>FWHM / FWTM 38.0° / 57.0°</p> <p>Efficiency 90 %</p> <p>Peak intensity 2.3 cd/m</p> <p>LEDs/each optic 1</p> <p>Light colour White</p> <p>Required components:</p>		

#### OPTICAL RESULTS (MEASURED):



LED NVSxE21A  
 FWHM / FWTM 39.0° / 59.0°  
 Efficiency 90 %  
 Peak intensity 2.1 cd/lm  
 LEDs/each optic 1  
 Light colour White  
 Required components:

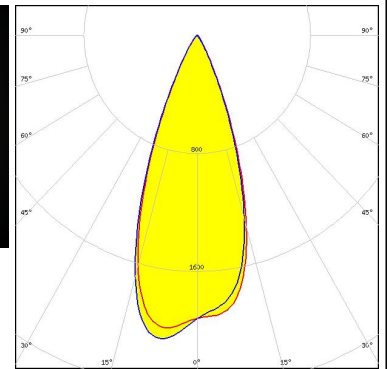
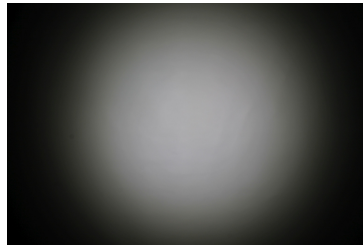

LED LH151B  
 FWHM / FWTM 33.0° / 53.0°  
 Efficiency 87 %  
 Peak intensity 2.6 cd/lm  
 LEDs/each optic 1  
 Light colour White  
 Required components:

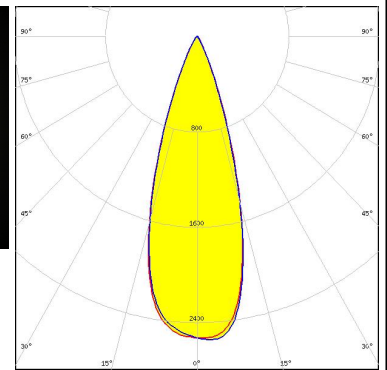
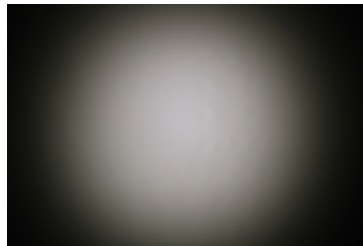

LED LH181B  
 FWHM / FWTM 42.0° / 63.0°  
 Efficiency 89 %  
 Peak intensity 1.8 cd/lm  
 LEDs/each optic 1  
 Light colour White  
 Required components:

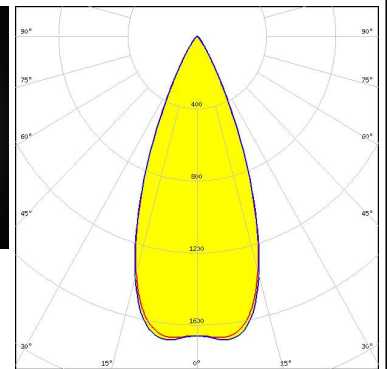
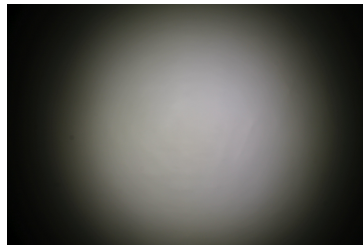

#### OPTICAL RESULTS (SIMULATED):

##### LUMILEDS

LED LUXEON CSP HL1  
 FWHM / FWTM 32.0° / 48.0°  
 Efficiency 96 %  
 Peak intensity 3.1 cd/lm  
 LEDs/each optic 1  
 Light colour White  
 Required components:

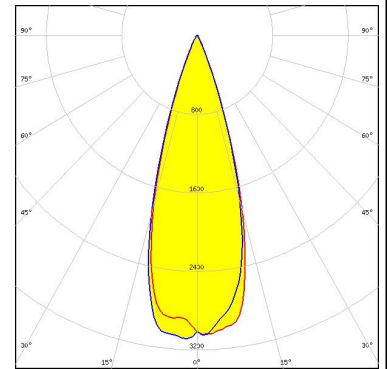

##### LUMILEDS

LED LUXEON HL1Z  
 FWHM / FWTM 38.0° / 56.0 + 55.0°  
 Efficiency 91 %  
 Peak intensity 2.3 cd/lm  
 LEDs/each optic 1  
 Light colour White  
 Required components:

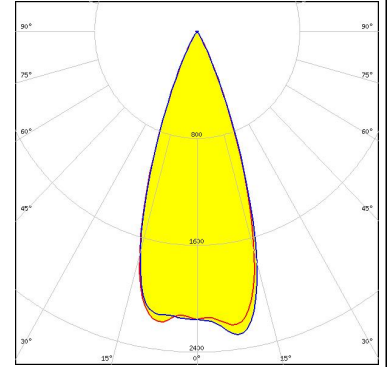

##### LUMILEDS

LED LUXEON HL2Z  
 FWHM / FWTM 42.0 + 41.0° / 61.0 + 60.0°  
 Efficiency 91 %  
 Peak intensity 2 cd/lm  
 LEDs/each optic 1  
 Light colour White  
 Required components:

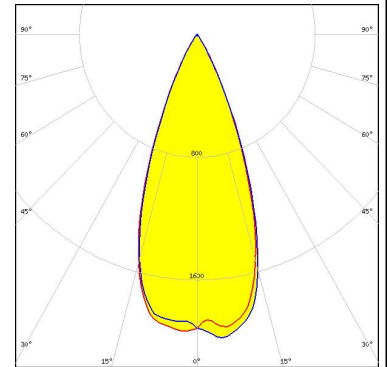

##### NICHIA

LED NFSWE11A  
 FWHM / FWTM 36.0° / 52.0°  
 Efficiency 85 %  
 Peak intensity 2.4 cd/lm  
 LEDs/each optic 1  
 Light colour White  
 Required components:

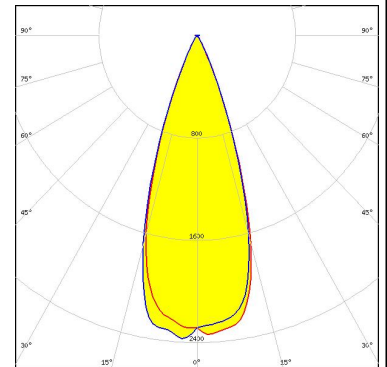

#### OPTICAL RESULTS (SIMULATED):

#### OSRAM

Opto Semiconductors

LED OSCONIQ C 2424  
FWHM / FWTM 46.0° / 66.0°  
Efficiency 92 %  
Peak intensity 1.7 cd/lm  
LEDs/each optic 1  
Light colour White  
Required components:

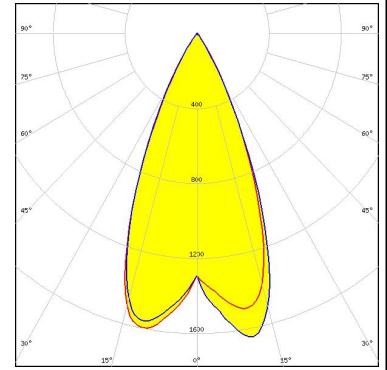

#### SAMSUNG

LED LM101B  
FWHM / FWTM 41.0°  
Efficiency 90 %  
Peak intensity 2.1 cd/lm  
LEDs/each optic 1  
Light colour White  
Required components:

#### SAMSUNG

LED LM231 A/B  
FWHM / FWTM 40.0° / 64.0°  
Efficiency 91 %  
Peak intensity 2.1 cd/lm  
LEDs/each optic 1  
Light colour White  
Required components:





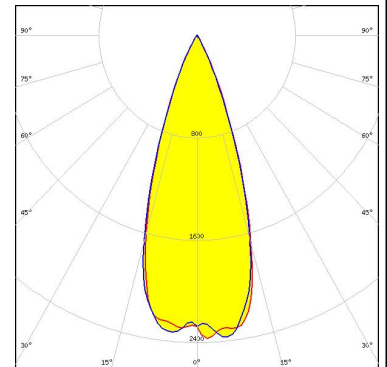

SEOUL SEMICONDUCTOR

LED Z8Y11  
FWHM / FWTM 35.0° / 54.0°  
Efficiency 87 %  
Peak intensity 2.4 cd/lm  
LEDs/each optic 1  
Light colour White  
Required components:

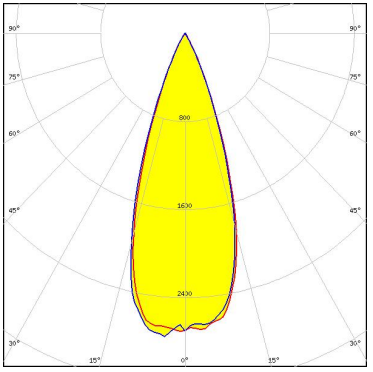

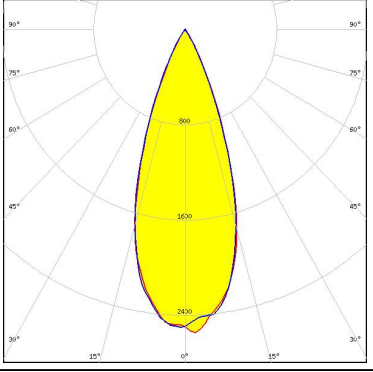
#### OPTICAL RESULTS (SIMULATED):

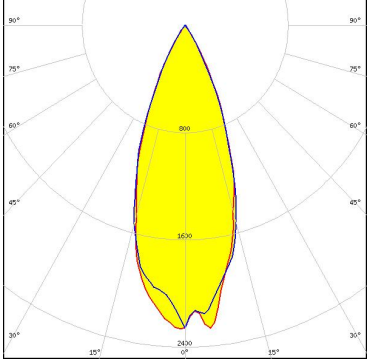
<p> SEOL SEMICONDUCTOR</p> <p>LED Z8Y15</p> <p>FWHM / FWTM 35.0° / 53.0°</p> <p>Efficiency 86 %</p> <p>Peak intensity 2.6 cd/lm</p> <p>LEDs/each optic 1</p> <p>Light colour White</p> <p>Required components:</p>	
<p> SEOL SEMICONDUCTOR</p> <p>LED Z8Y19</p> <p>FWHM / FWTM 37.0° / 56.0°</p> <p>Efficiency 87 %</p> <p>Peak intensity 2.3 cd/lm</p> <p>LEDs/each optic 1</p> <p>Light colour White</p> <p>Required components:</p>	
<p> SEOL SEMICONDUCTOR</p> <p>LED Z8Y22</p> <p>FWHM / FWTM 36.0° / 60.0°</p> <p>Efficiency 86 %</p> <p>Peak intensity 2.1 cd/lm</p> <p>LEDs/each optic 1</p> <p>Light colour White</p> <p>Required components:</p>	

### GENERAL INFORMATION:

NOTE: The typical beam angle will be changed by different color, chip size and chip position tolerance. The typical total beam angle is the full angle measured where the luminous intensity is half of the peak value.

### MATERIALS:

As part of our continuous research and improvement processes, and to ensure the best possible quality and availability of our products, LEDiL reserves the right to change material grades without notice.

### PRODUCT DATA USER AGREEMENT AND DISCLAIMER:

The measured data in the provided downloadable LEDiL Product Datasheets and Mechanical 2D-Drawings is rounded and provided as reference for planning. LEDiL Oy's optical specifications have been verified by conducting performance testing of the products in accordance with the company's quality system. The reported data are averaged results of multiple measurements with typical variation. LEDiL Oy reserves the right to without prior notification make changes and improvements to its products.

LEDiL Oy assumes neither warranty, nor guarantee nor any other liability of any kind for the contents and correctness of the provided data. The provided data has been generated with highest diligence but the provided data may in reality not represent the complete possible variation range of all intrinsic parameters. Therefore, in certain cases a deviation from the provided data could occur.

LEDiL Oy reserves the right to undertake technical changes of its products without further notification which could lead to changes in the provided data. LEDiL Oy assumes no liability of any kind for the possible deviation from any provided data or any other damage resulting from the usage of the provided data.

The user agrees to this disclaimer and user agreement with the download or usage of the provided files.

#### LEDiL Oy

Joensuunkatu 13  
FI-24240 SALO  
Finland

#### LEDiL Inc.

228 West Page Street  
Suite D  
Sycamore IL 60178  
USA

#### Ledil Optics Technology (Shenzhen) Co., Ltd.

# 405 , Block B  
Casic Motor Building  
Shenzhen 518057  
P.R.CHINA

#### Local sales and technical support

[www.ledil.com/  
where\\_to\\_buy](http://www.ledil.com/where_to_buy)

#### Shipping locations

Salo, Finland  
Hong Kong, China

#### Distribution Partners

[www.ledil.com/  
where\\_to\\_buy](http://www.ledil.com/where_to_buy)