



Rugged Long Range Radio (LoRa) Transmitter

- 16 Switch Radio Transmitter
- Range
 - LORA Mode 7 upto **16km**
 - LORA Mode 1 upto **5Km**
 - FM Mode upto **4Km**
- Optional “Acknowledge” indication from Receiver
- Compatible with RF Solutions Receivers
- Waterproof to IP67
- Internal Lithium-ion Rechargeable Battery
- Recharge via either:
 - Micro USB Socket (type C)
 - Wireless Recharging
- Supplied Ready to Go
- 868/918MHz FM Technology
- RED (CE) Compliant / FCC Certified.



Applications

- Industrial Remote Switching
- Reliable Remote Switching
- Long Range Control

Description

CARLTON is a rugged RF Transmitter which can operate with many RF Solutions receivers to generate a Range Remote Control System. Carlton can operate in several Modes of operation, providing short or longer range. It can be optionally set to request feedback from the receiver to provide the user with visual feedback, and can also provide an automatic background “Watchdog” Transmissions.

Housed in an IP67 rated waterproof enclosure, CARLTON has an internal rechargeable Lithium battery which can be recharged via either the external microUSB socket (type C) or wireless recharging pad (using a standard Qi, Apple or Samsung Wireless compatible).

Part Number	Description
CARLTON-8T16	16 channel Transmitter 16Km 868MHz
CARLTON-9T16	16 channel Transmitter 16Km 918MHz

CARLTON FM/LoRa Transmitter



Compatible Receivers

CARLTON Transmitter is compatible with all RF Solutions LoRa Receivers.

PRO Series Receiver Units

IP65 Receiver with DIN Rail Modules
4, 8, 16 Channels Changeover Contacts
expandable to 250 using add-on Relay modules
110-230Vac or 12-30Vdc supply



725 DIN Rail Module

DIN Rail Receiver
2 Channels Relay changeover contact outputs
expandable to 250 using add-on Relay modules
12-30Vdc supply



SLIMDIN Receiver

Compact DIN Rail Receiver
4 Channels Relay outputs
12-30Vdc supply



GAMMA-OEM RF Module

RF module with 8 Digital and serial outputs
SMT or DIP versions

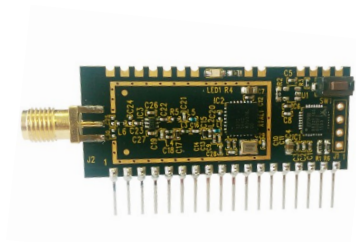

CARLTON FM/LoRa Transmitter



Operation

Press any of the switches to operate.

The Transmitter will auto sleep between operations to save power

The LED's indicate the following:

RF Transmit GREEN LED operates when CARLTON is transmitting an RF signal

RF Acknowledge (if configured) :

GREEN LED will Flash at high speed to indicate that an acknowledgment **has** successfully been received back form the receiver

RED LED will Flash at high speed to indicate that an acknowledgment **has not** been received back form the receiver

Low Battery: If battery requires recharging Low Battery LED illuminates for 3 seconds after each operation.

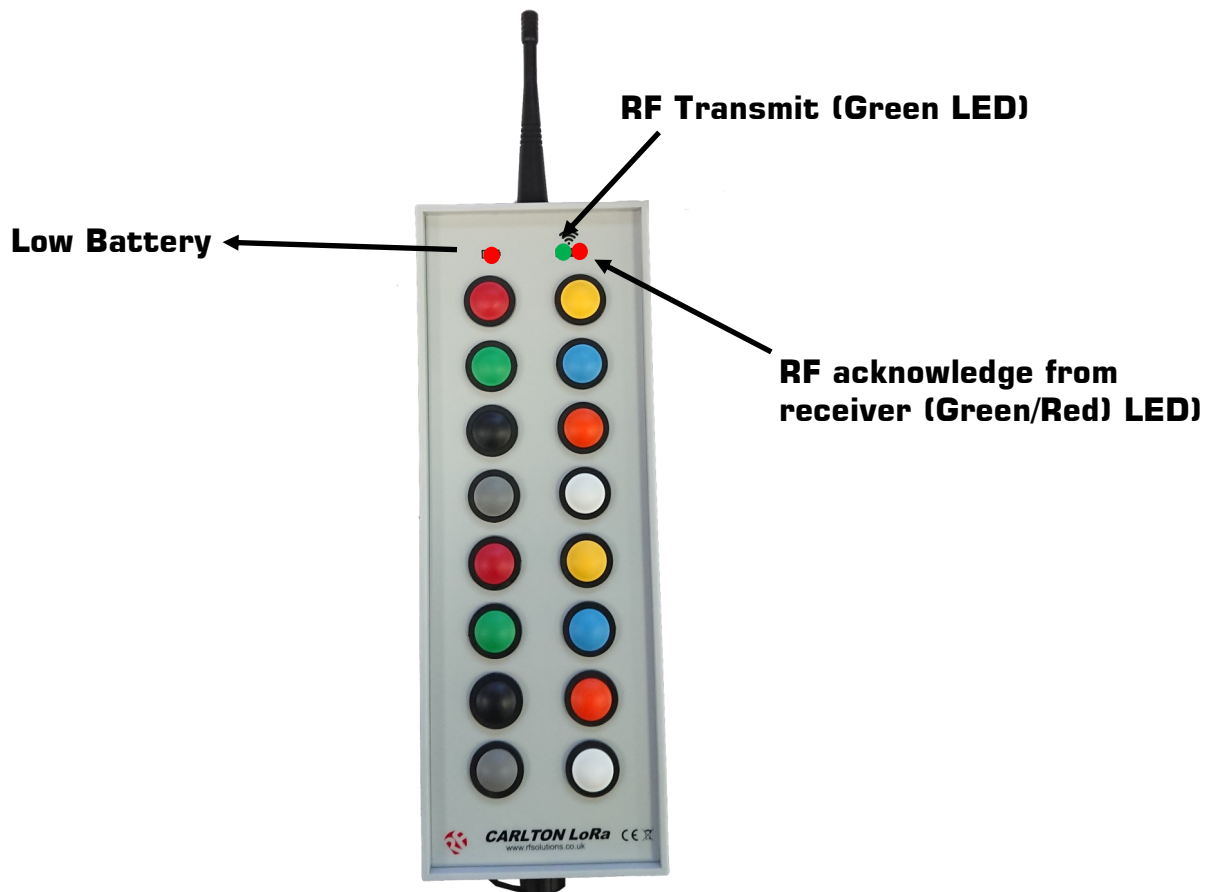

CARLTON is factory shipped with the following default settings

FM RF Transmission

Acknowledgement not requested

Watchdog Inactive

Continuous Transmission when Switch pressed

Recharging the Battery

CARLTON contains an internal Lithium battery which can be recharged via the USB connector or, using a wireless charging pad.

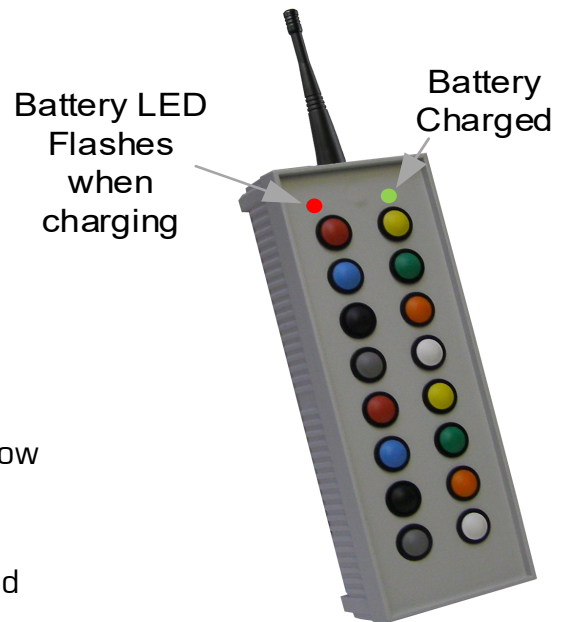

When Charging the Battery **RED** LED gives a slow Flash indicates charging is in progress.

When fully charged the **GREEN** LED is illuminated

Recharging using USB Cable

Connect using the uUSB Type C Connector



Wireless Recharging

Carlton is compatible with the Qi standard (e.g. Apple or Samsung standard Wireless charging pads)



Configuring Modes of Operation

To configure the modes of operation, unscrew the six enclosure fixing screws to access the internal circuit board.

The SET switch is used to configure the operating modes

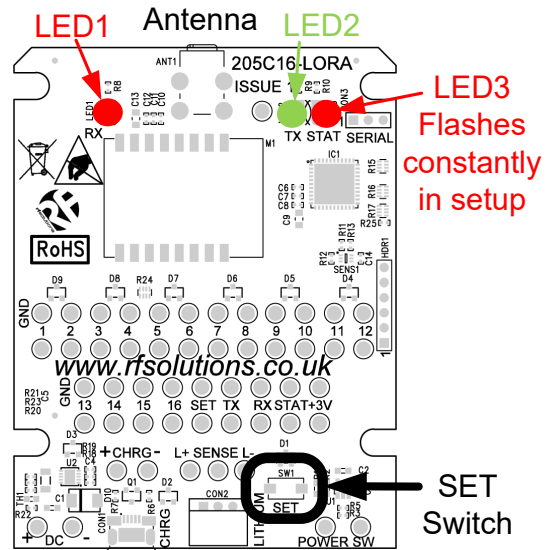

The Following Modes can be configured using the SET Switch

1. RF Mode of Transmission (FM or LORA Mode)
2. Acknowledgement back from the Receiver
3. Automatic Watchdog Transmissions
4. Continuous or State Change Transmission

CARLTON Transmitters are factory Shipped with the following Settings

RF Transmission	FM
Acknowledgment	OFF
Watchdog	OFF
Transmission Type	Continuous

Restoring CARLTON to Factory Default

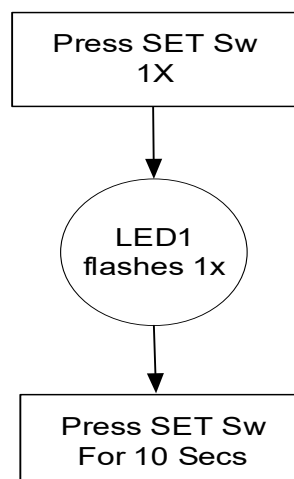

To Set the RF Transmission MODE

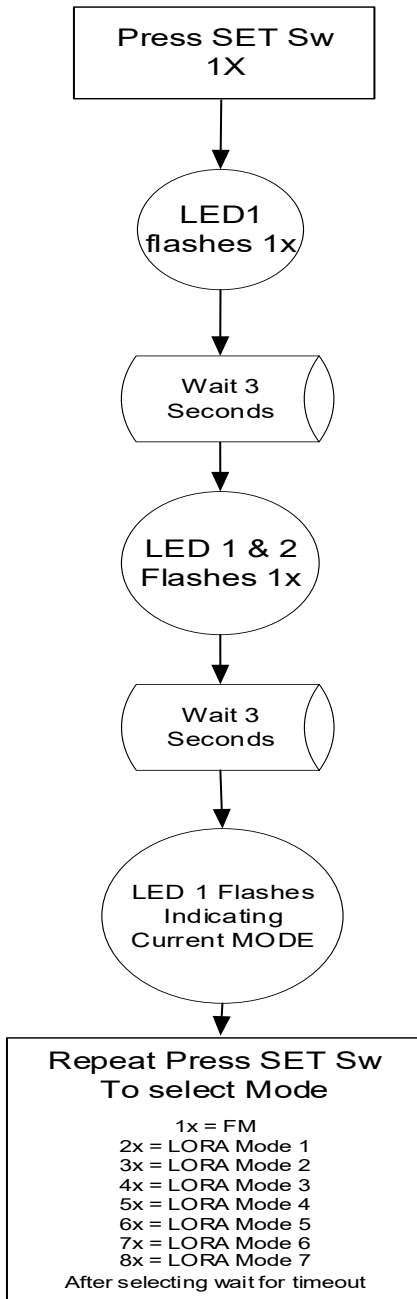

This sets the type of RF Transmission.

Possible options are FM, or LORA Modes 0 - 7
FM or LORA mode 0 provides the quickest response; from Transmitter sw pressed to Receiver Relay output.

LORA mode 7 provides the longest operating range but with the longest time delay of from button press to receiver relay actuation.

Notes

1. Range is dependant on many factors including the mode of transmission. Range can be reduced by 75% in built up areas with poor antenna, and environmental conditions
2. Battery life quoted is approximate based on 30 operations per day.

RF Transmission	Mode (No of LED1 Flashes)	Propagation Time from TX to output Activated (approx)	Operations from a Single battery charge
FM	1	20 mS	1 Million
LoRa Mode 1	2	20 mS	~550K
LoRa Mode 2	3	40 mS	288K
LoRa Mode 3	4	80 mS	144K
LoRa Mode 4	5	160 mS	72K
LoRa Mode 5	6	320 mS	36K
LoRa Mode 6	7	640 mS	18K
LoRa Mode 7	8	1.28 Secs	~9,000

To Set Acknowledgement Request

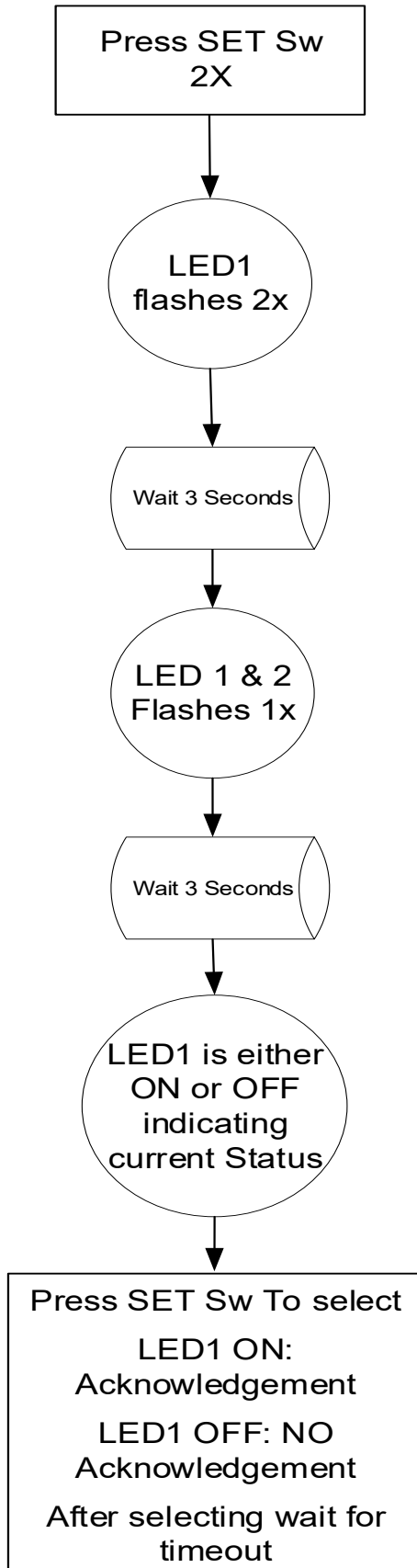

Acknowledgement Feature provides the user with LED indication that the receiver has successfully received the transmitters signal.

When activated the CARLTON Transmitter includes an acknowledgement request within each radio transmission.

The response from the receiver is indicated on the transmitter via the RED / GREEN LEDs.

RF Acknowledgment from Receiver - Warning!

When Acknowledgement is ON, CARLTON requests an RF signal back from the receiver. Whilst in theory if an RF signal can be transmitted one way then it can be returned, in practice occasionally the received acknowledgement may not penetrate as well as the CARLTON transmitted signal.

To Set Watchdog Transmissions

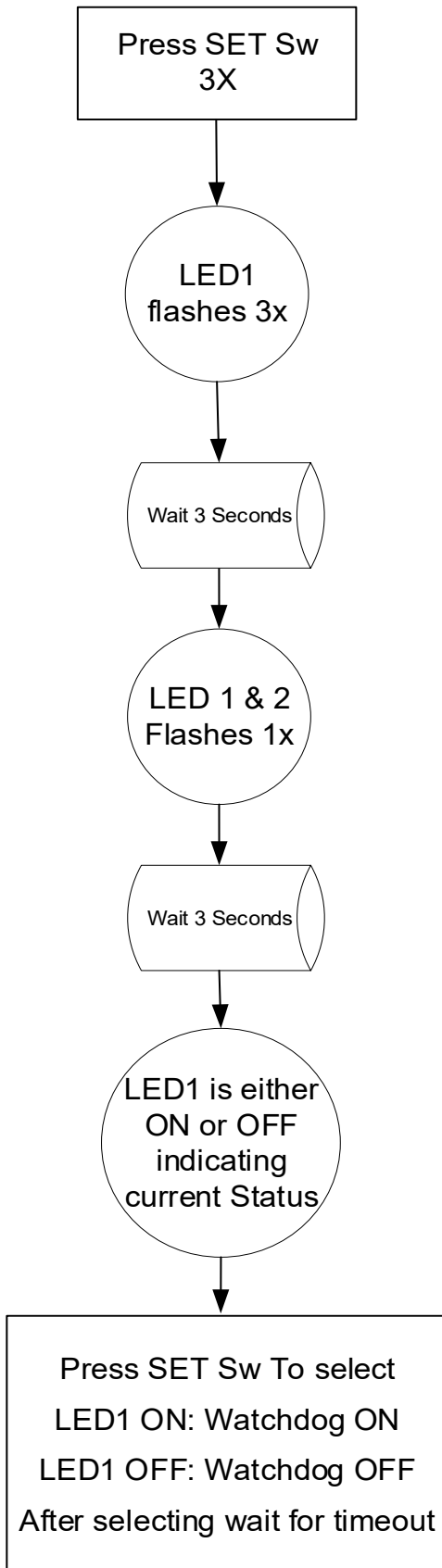

If enabled, CARLTON automatically transmits a background “watchdog” RF Signal approx. every ~45 secs,

RF Solutions Receivers with a Watchdog feature will hold a Relay contact “ENERGISED” as long as Watchdog is regularly received confirming the transmitter is in range and the system is operating correctly.

When using Watchdog it may be useful to incorporate a Power Switch to avoid premature battery discharge

A power switch can be incorporated If this is required please contact our sales Dept.

To Set Continuous or State Change RF Transmissions

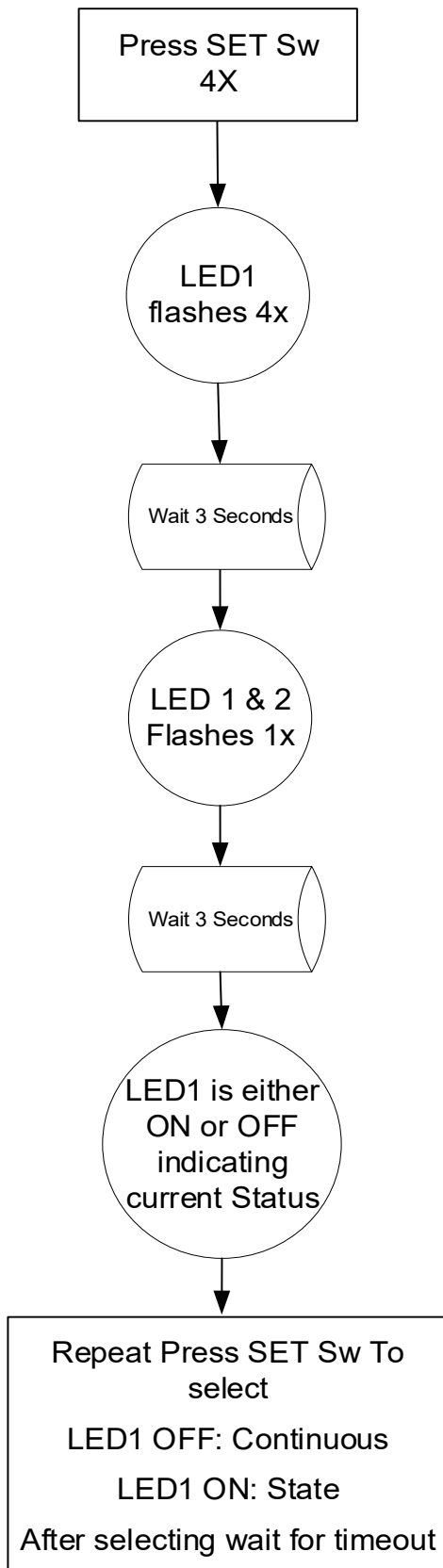

When a switch button is operated CARLTON will transmit a "Button Down" RF Transmission
When a switch button is released CARLTON will transmit a "Button Up" RF Transmission

Continuous Transmit

CARLTON repeat transmits "button Down" in short bursts for as long as switch button is pressed.

If the Acknowledgment is ON the receiver will reply after each RF transmission burst.

This is ideally suited to momentary operation where the receiver output needs to be active as long as the user presses down a CARLTON Button .

State Change Transmit

CARLTON transmits an RF transmission only when the switch button is pressed or released (i.e a state change).

On each of these "state changes" CARLTON transmits upto 4 transmissions, or, "RF packets" (which can be seen by the GREEN LED flashing upto 4 times, If the Acknowledgment is ON the receiver will reply immediately.

After receiving an Acknowledgment the CARLTON will cease sending any remaining of the 4 transmissions.

CARLTON FM/LoRa Transmitter



Technical Specifications

Enclosure Rating: IP67
Battery Type: Lithium Polymer 3.7V 980mAh
Operating Temperature -10 to +60 °C

Electrical Characteristics	Min	Typical	Max	Units
Supply Voltage	3.0	4.5	5	V
Frequency:		869.500 918.000 2400		MHz
RF Output Power (ERP) 869.50MHz 918MHz 2.4GHz			+22 +22 +14	dBm

SUPPLIER'S DECLARATION OF CONFORMITY

This device complies with part 15 of the FCC Rules Operation is subject to the following two conditions: (1) This device may not cause harmful interference, and (2) this device must not accept any interference received, including interference that may cause undesired operation.

47 CFR 2.1077 Compliance Information

This Declaration of Conformity is hereby issued according to Chapter 1, Subpart A, Part 2 of Title 47 of the code of Federal Regulations by:

RF Solutions Limited
William Alexander House
William Way
Burgess Hill
West Sussex
RH15 9AG
United Kingdom

Trade Name	Model
RF Solutions LoRa Carlton	CARLTON-9T16



Contains FCC ID: P90LAMBDA62

Complies with FCC Part 15.247

United States Responsible Party

Violette Engineering Corporation, 6731 Whittier Avenue, McLean, VA 22101
info@violettecorp.com

The responsible party warrants that each unit of equipment marketed under this Declaration of Conformity will be identical to the unit tested and found acceptable with the standards and that the records maintained by the responsible party continue to reflect the equipment being produced under such Supplier's Declaration of Conformity continue to comply within the variation that can be expected due to quantity production and testing on a statistical basis.

Australia SRD Certification (918MHz versions)

At the time of writing the CARLTON is at the Test lab undergoing approvals testing. This is expected to be completed during 2021.

CARLTON FM/LoRa Transmitter



Simplified Declaration of Conformity (RED)

BG - С настоящото RF Solutions Limited декларира, че този тип радиосъоръжение Carlton-8T16 е в съответствие с Директива 2014/53/ЕС. Цялостният текст на ЕС декларацията за съответствие може да се намери на следния интернет адрес: www.rfsolutions.co.uk

CS - Tímto RF Solutions Limited prohlašuje, že typ rádiového zařízení Carlton-8T16 je v souladu se směrnicí 2014/53/EU. Úplné znění EU prohlášení o shodě je k dispozici na této internetové adrese: www.rfsolutions.co.uk

DA - Hermed erklærer RF Solutions Limited, at radioudstyrstypen Carlton-8T16 er i overensstemmelse med direktiv 2014/53/EU. EU-overensstemmelseserklæringens fulde tekst kan findes på følgende internetadresse: www.rfsolutions.co.uk

DE - Hiermit erkläre RF Solutions Limited, dass der Funkanlagentyp Carlton-8T16 der Richtlinie 2014/53/EU entspricht. Der vollständige Text der EU-Konformitätserklärung ist unter der folgenden Internetadresse verfügbar: www.rfsolutions.co.uk

EL - Με την παρούσα ο/η RF Solutions Limited, δηλώνει ότι ο ραδιοεξοπλισμός Carlton-8T16 πληροί την οδηγία 2014/53/ΕΕ. Το πλήρες κείμενο της δήλωσης συμμόρφωσης ΕΕ διατίθεται στην ακόλουθη ιστοσελίδα στο διαδίκτυο: www.rfsolutions.co.uk

EN - Hereby, RF Solutions Limited declares that the radio equipment type Carlton-8T16 is in compliance with Directive 2014/53/EU. The full text of the EU declaration of conformity is available at the following internet address: www.rfsolutions.co.uk

ES - Por la presente, RF Solutions Limited declara que el tipo de equipo radioeléctrico Carlton-8T16 es conforme con la Directiva 2014/53/UE. El texto completo de la declaración UE de conformidad está disponible en la dirección Internet siguiente: www.rfsolutions.co.uk

ET - Käesolevaga deklareerib RF Solutions Limited, et käesolev raadioseadme tüüp Carlton-8T16 vastab direktiivi 2014/53/EL nõuetele. ELi vastavusdeklaratsiooni täielik tekst on kättesaadav järgmisel internetiaadressil: www.rfsolutions.co.uk

FI - RF Solutions Limited vakuuttaa, että radiolaitetyyppi Carlton-8T16 on direktiivin 2014/53/EU mukainen. EU-vaatimustenmukaisuusvakuutuksen täysimittainen teksti on saatavilla seuraavassa internetosoitteessa: www.rfsolutions.co.uk

FR - Le soussigné, RF Solutions Limited, déclare que l'équipement radioélectrique du type Carlton-8T16 est conforme à la directive 2014/53/UE. Le texte complet de la déclaration UE de conformité est disponible à l'adresse internet suivante: www.rfsolutions.co.uk

HR - RF Solutions Limited ovime izjavljuje da je radijska oprema tipa Carlton-8T16 u skladu s Direktivom 2014/53/EU. Cjeloviti tekst EU izjave o sukladnosti dostupan je na sljedećoj internetskoj adresi: www.rfsolutions.co.uk

HU - RF Solutions Limited igazolja, hogy a Carlton-8T16 típusú rádióberendezés megfelel a 2014/53/EU irányelvnek. Az EU-megfelelőségi nyilatkozat teljes szövege elérhető a következő internetes címen: www.rfsolutions.co.uk

IT - Il fabbricante, RF Solutions Limited, dichiara che il tipo di apparecchiatura radio Carlton-8T16 è conforme alla direttiva 2014/53/UE. Il testo completo della dichiarazione di conformità UE è disponibile al seguente indirizzo Internet: www.rfsolutions.co.uk

LT - Aš, RF Solutions Limited, patvirtinu, kad radijo įrenginių tipas Carlton-8T16 atitinka Direktyvą 2014/53/ES. Visas ES atitikties deklaracijos tekstas prieinamas šiuo interneto adresu: www.rfsolutions.co.uk

LV - Ar šo RF Solutions Limited deklarē, ka radioiekārta Carlton-8T16 atbilst Direktīvai 2014/53/ES. Pilns ES atbilstības deklarācijas teksts ir pieejams šādā interneta vietnē: www.rfsolutions.co.uk

MT - B'dan, RF Solutions Limited, niddikjara li dan it-tip ta' tagħmir tar-radju Carlton-8T16 huwa konformi mad-Direttiva 2014/53/UE. It-test kollu tad-dikjarazzjoni ta' konformità tal-UE huwa disponibbli f'dan l-indirizz tal-Internet li ġej: www.rfsolutions.co.uk

NL - Hierbij verklaar ik, RF Solutions Limited, dat het type radioapparatuur Carlton-8T16 conform is met Richtlijn 2014/53/EU. De volledige tekst van de EU-conformiteitsverklaring kan worden geraadpleegd op het volgende internetadres: www.rfsolutions.co.uk

PL - RF Solutions Limited niniejszym oświadczam, że typ urządzenia radiowego Carlton-8T16 jest zgodny z dyrektywą 2014/53/UE. Pełny tekst deklaracji zgodności UE jest dostępny pod następującym adresem internetowym: www.rfsolutions.co.uk

PT - O(a) abaixo assinado(a) RF Solutions Limited declara que o presente tipo de equipamento de rádio Carlton-8T16 está em conformidade com a Diretiva 2014/53/UE. O texto integral da declaração de conformidade está disponível no seguinte endereço de Internet: www.rfsolutions.co.uk

RO - Prin prezenta, RF Solutions Limited declară că tipul de echipamente radio Carlton-8T16 este în conformitate cu Directiva 2014/53/UE. Textul integral al declarației UE de conformitate este disponibil la următoarea adresă internet: www.rfsolutions.co.uk

SK - RF Solutions Limited týmto vyhlasuje, že rádiové zariadenie typu Carlton-8T16 je v súlade so smernicou 2014/53/EÚ. Úplné EÚ vyhlásenie o zhode je k dispozícii na tejto internetovej adrese: www.rfsolutions.co.uk

SL - RF Solutions Limited potrjuje, da je tip radijske opreme Carlton-8T16 skladen z Direktivo 2014/53/EU. Celotno besedilo izjave EU o skladnosti je na voljo na naslednjem spletnem naslovu: www.rfsolutions.co.uk

SV - Härmed försäkrar RF Solutions Limited att denna typ av radioutrustning Carlton-8T16 överensstämmer med direktiv 2014/53/EU. Den fullständiga texten till EU-försäkran om överensstämmelse finns på följande webbadress: www.rfsolutions.co.uk

RF Solutions Ltd. Recycling Notice

Meets the following EC Directives:

DO NOT

Discard with normal waste, please recycle.

ROHS Directive 2011/65/EU and amendment 2015/863/EU:

Specifies certain limits for hazardous substances.

WEEE Directive 2012/19/EU waste electrical & electronic equipment. This product must be disposed of through a licensed WEEE collection point. RF Solutions Ltd., fulfils its WEEE obligations by membership of an approved compliance scheme.

Environment Agency Registration Number: WEE/JB0104WV.



Waste Batteries and Accumulators Directive 2006/66/EC

Where batteries are fitted, before recycling the product, the batteries must be removed and disposed of at a licenced collection point. RF Solutions battery producer number:

BPRN00060.

Disclaimer:

Whilst the information in this document is believed to be correct at the time of issue, RF Solutions Ltd does not accept any liability whatsoever for its accuracy, adequacy or completeness. No express or implied warranty or representation is given relating to the information contained in this document. RF Solutions Ltd reserves the right to make changes and improvements to the product(s) described herein without notice. Buyers and other users should determine for themselves the suitability of any such information or products for their own particular requirements or specification(s). RF Solutions Ltd shall not be liable for any loss or damage caused as a result of user's own determination of how to deploy or use RF Solutions Ltd's products. Use of RF Solutions Ltd products or components in life support and/or safety applications is not authorised except with express written approval. No licences are created, implicitly or otherwise, under any of RF Solutions Ltd's intellectual property rights. Liability for loss or damage resulting or caused by reliance on the information contained herein or from the use of the product (including liability resulting from negligence or where RF Solutions Ltd was aware of the possibility of such loss or damage arising) is excluded. This will not operate to limit or restrict QuasarUK Ltd's liability for death or personal injury resulting from its negligence.