

STELLA-RS

~25° spot beam. Compatible with up to 30 mm LES size COBs. Variant with black frame.

SPECIFICATION:

Dimensions	Ø 90.0 mm
Height	39.2 mm
Fastening	screw
Ingress protection classes	IP67
ROHS compliant	yes ⓘ

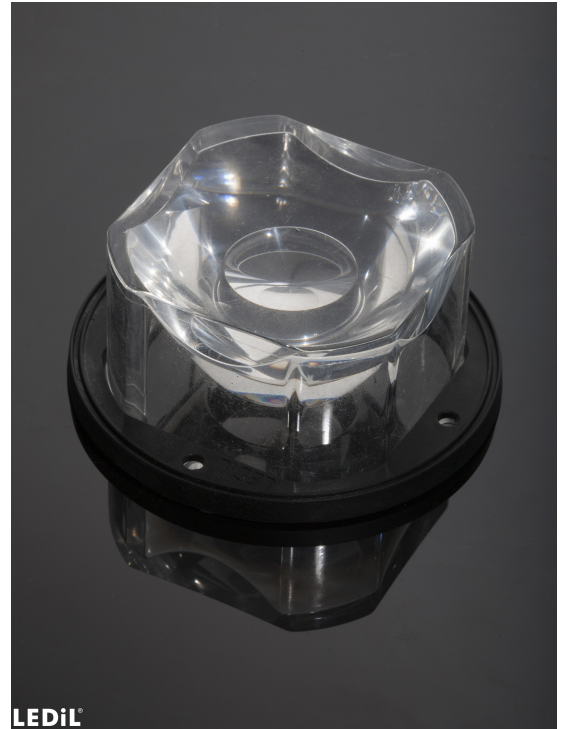

MATERIALS:

Component	Type	Material	Colour	Finish
STELLA-RS	Single lens	Silicone	clear	
STELLA-FRAME	Holder	PA66	black	





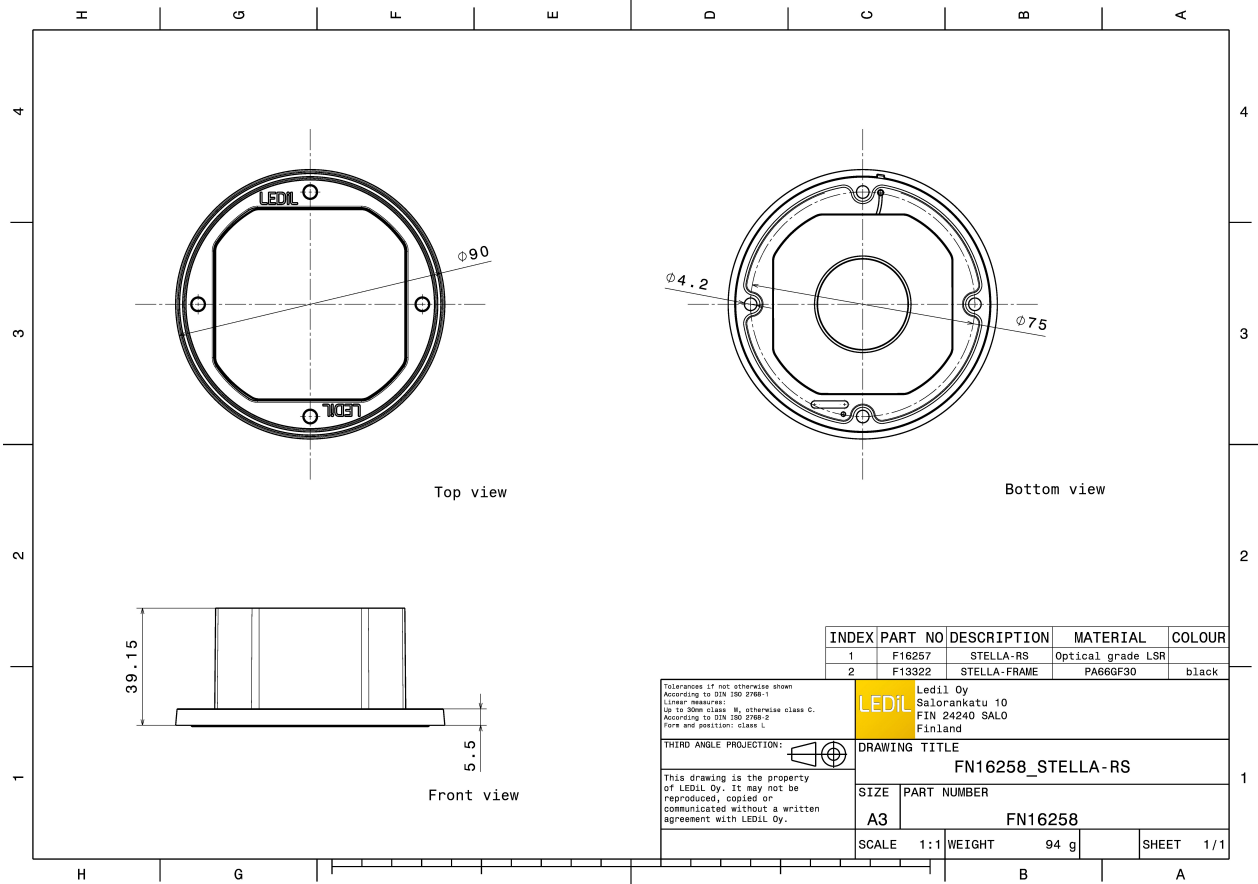



ORDERING INFORMATION:

Component		Qty in box	MOQ	MPQ	Box weight (kg)
FN16258_STELLA-RS	Single lens	90	90	15	9.8
» Box size: 480 x 280 x 300 mm					

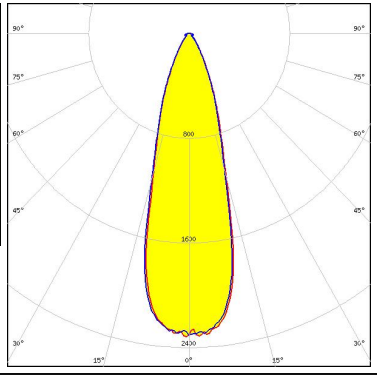

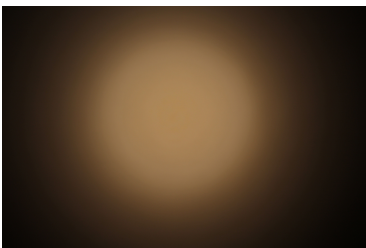
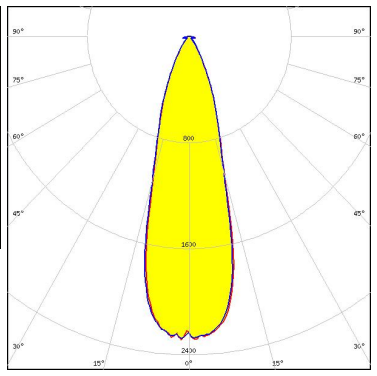

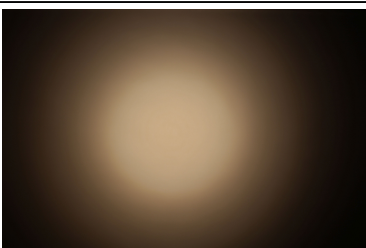
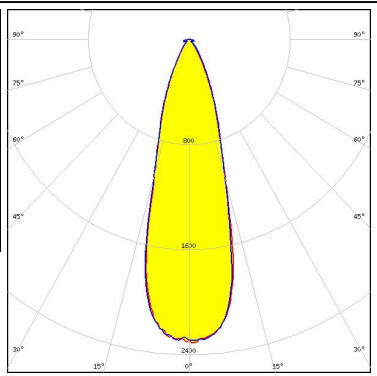

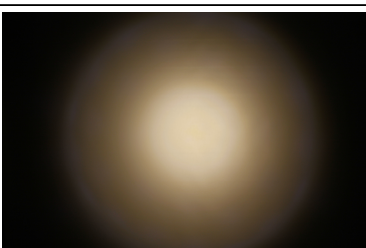
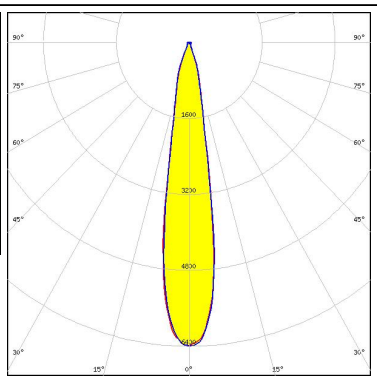
See also our general installation guide: www.ledil.com/installation_guide

OPTICAL RESULTS (MEASURED):

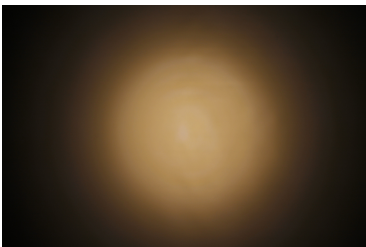
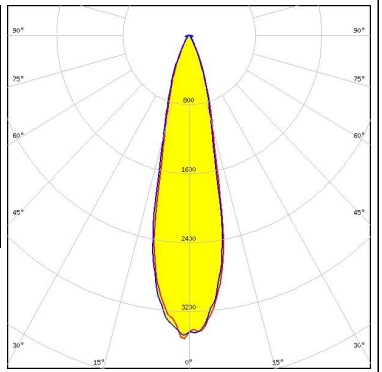
<p></p> <p>LED V22 Gen7 FWHM / FWTM 29.0° / 60.0° Efficiency 94 % Peak intensity 2.3 cd/lm LEDs/each optic 1 Light colour White Required components: TE Connectivity: 2213480-1</p>		
<p></p> <p>LED V22 Gen7 FWHM / FWTM 29.0° / 59.0° Efficiency 94 % Peak intensity 2.3 cd/lm LEDs/each optic 1 Light colour White Required components:</p>		
<p></p> <p>LED V22 Gen7 FWHM / FWTM 29.0° / 59.0° Efficiency 94 % Peak intensity 2.3 cd/lm LEDs/each optic 1 Light colour White Required components: Bender Wirth: 431 Typ Z1</p>		
<p></p> <p>LED VERO13 FWHM / FWTM 18.0° / 38.0° Efficiency 94 % Peak intensity 6.4 cd/lm LEDs/each optic 1 Light colour White Required components:</p>		

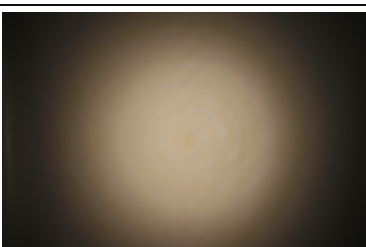
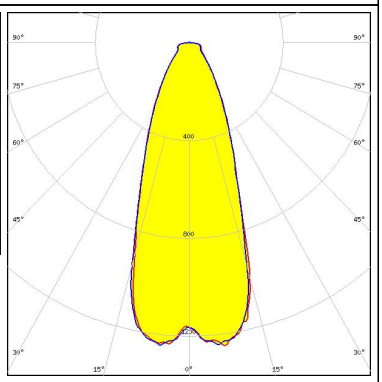
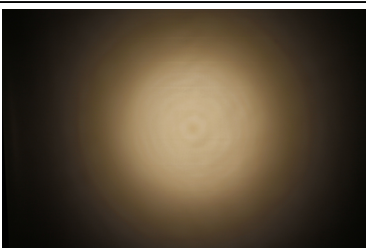
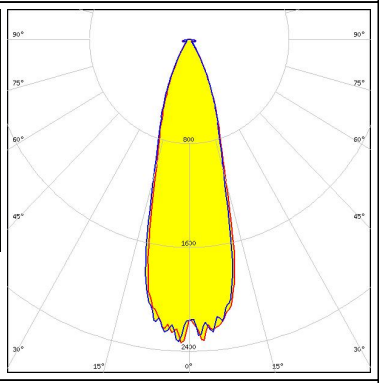
OPTICAL RESULTS (MEASURED):

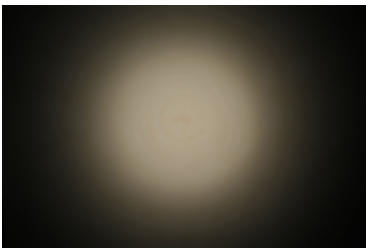
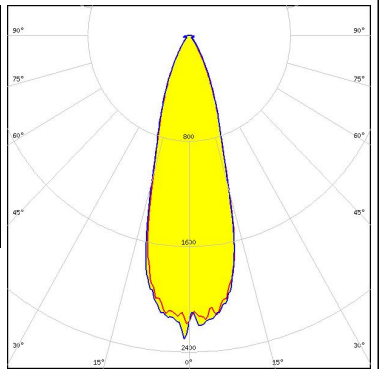
<p></p> <p>LED VERO18 FWHM / FWTM 24.0° / 49.0° Efficiency 94 % Peak intensity 3.5 cd/lm LEDs/each optic 1 Light colour White Required components:</p>		
<p></p> <p>LED VERO29 FWHM / FWTM 39.0° / 84.0° Efficiency 94 % Peak intensity 1.3 cd/lm LEDs/each optic 1 Light colour White Required components:</p>		
<p>CITIZEN</p> <p>LED CLL04x/CLU04x FWHM / FWTM 29.0° / 58.0° Efficiency 94 % Peak intensity 2.4 cd/lm LEDs/each optic 1 Light colour White Required components:</p>		
<p></p> <p>LED CXA/B 30xx FWHM / FWTM 31.0° / 61.0° Efficiency 94 % Peak intensity 2.3 cd/lm LEDs/each optic 1 Light colour White Required components:</p>		

OPTICAL RESULTS (MEASURED):

LUMILEDS

LED LUXEON CoB 1211
 FWHM / FWTM 26.0° / 53.0°
 Efficiency 94 %
 Peak intensity 3 cd/m
 LEDs/each optic 1
 Light colour White
 Required components:
 Bender Wirth: 431 Typ L3

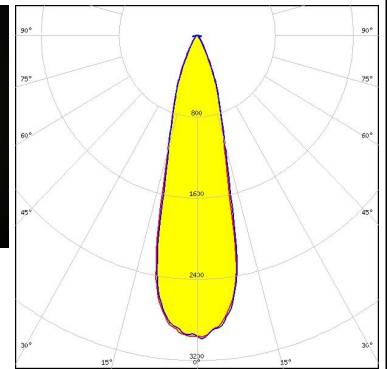
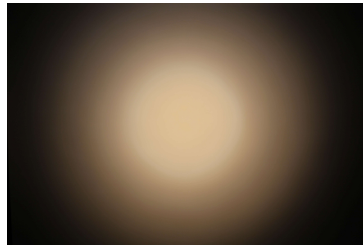

NICHIA

LED COB H-Type
 FWHM / FWTM 30.0° / 61.0°
 Efficiency 94 %
 Peak intensity 2.2 cd/m
 LEDs/each optic 1
 Light colour White
 Required components:

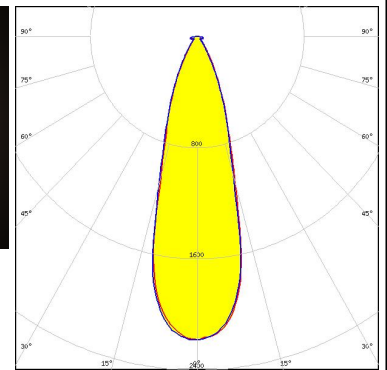
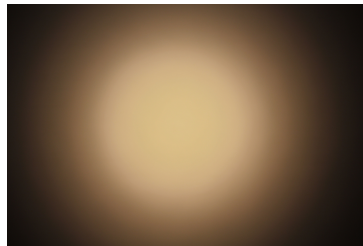

NICHIA

LED COB J-Type
 FWHM / FWTM 20.0° / 42.0°
 Efficiency 94 %
 Peak intensity 5 cd/m
 LEDs/each optic 1
 Light colour White
 Required components:

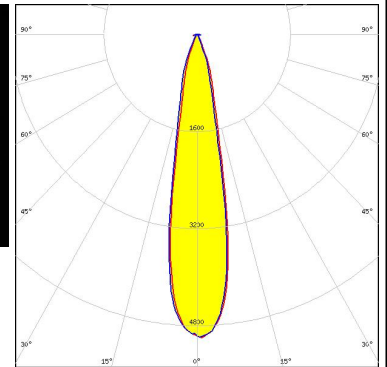





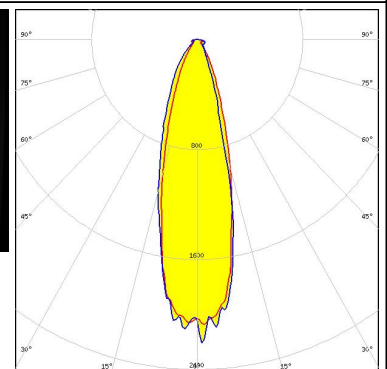
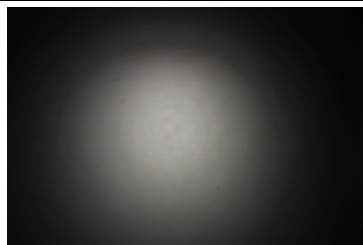

SAMSUNG

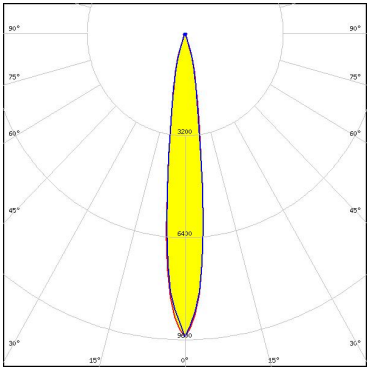

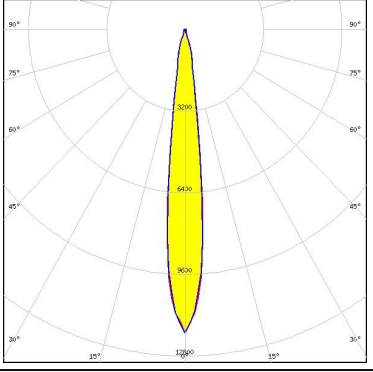

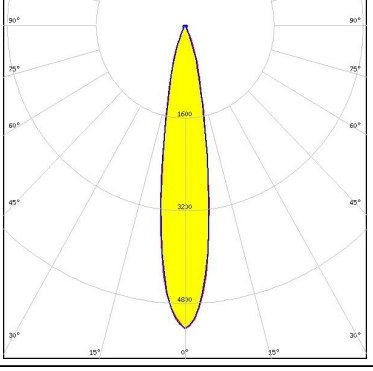
LED LC040D / LC060D / LC080D
 FWHM / FWTM 29.0° / 62.0°
 Efficiency 93 %
 Peak intensity 2.2 cd/m
 LEDs/each optic 1
 Light colour White
 Required components:

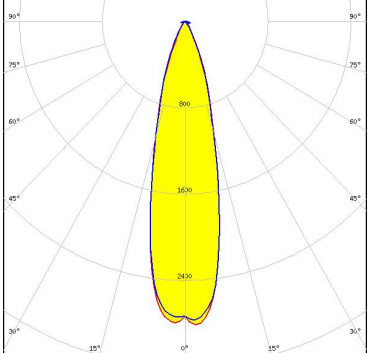

OPTICAL RESULTS (SIMULATED):

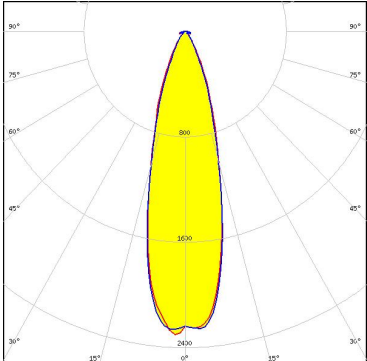
<p></p> <p>LED V10 Gen7 FWHM / FWTM 14.0° / 32.0° Efficiency 96 % Peak intensity 9.9 cd/lm LEDs/each optic 1 Light colour White Required components: Bender Wirth: 486 Typ L1</p>	
<p></p> <p>LED VERO10 FWHM / FWTM 13.0° / 28.0° Efficiency 94 % Peak intensity 11.9 cd/lm LEDs/each optic 1 Light colour White Required components:</p>	
<p></p> <p>LED Vesta TW 13mm (18W) DP FWHM / FWTM 18.0° / 40.0° Efficiency 86 % Peak intensity 5.2 cd/lm LEDs/each optic 1 Light colour Tunable White Required components:</p>	
<p></p> <p>LED Vesta TW 18mm (31W) DP FWHM / FWTM 26.0° / 52.0° Efficiency 86 % Peak intensity 2.8 cd/lm LEDs/each optic 1 Light colour Tunable White Required components:</p>	

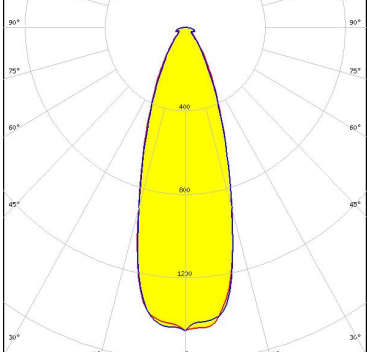
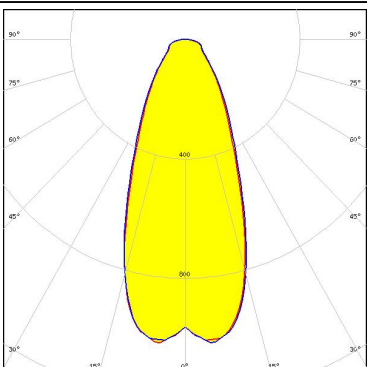
OPTICAL RESULTS (SIMULATED):

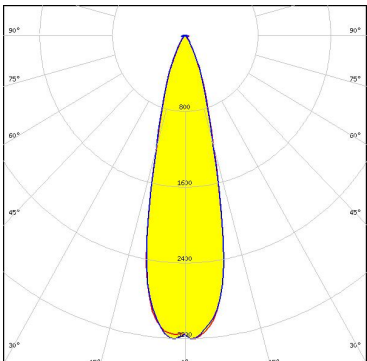
<p> LED Vesta TW 22mm DP FWHM / FWTM 28.0° / 57.0° Efficiency 86 % Peak intensity 2.3 cd/lm LEDs/each optic 1 Light colour Tunable White Required components:</p>	
<p> LED Vesta TW 29mm DP FWHM / FWTM 35.0° / 72.0° Efficiency 86 % Peak intensity 1.5 cd/lm LEDs/each optic 1 Light colour Tunable White Required components:</p>	
<p>CITIZEN LED CLL05x/CLU05x FWHM / FWTM 43.0° / 98.0° Efficiency 94 % Peak intensity 1 cd/lm LEDs/each optic 1 Light colour White Required components:</p>	
<p> LED CMA2550 FWHM / FWTM 27.0° / 52.0° Efficiency 94 % Peak intensity 3.2 cd/lm LEDs/each optic 1 Light colour White Required components:</p>	

OPTICAL RESULTS (SIMULATED):

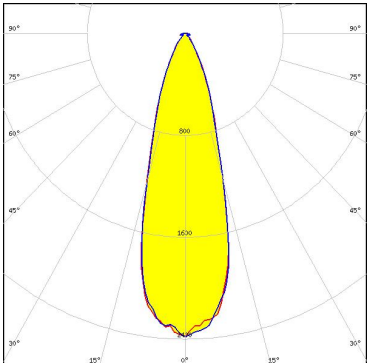
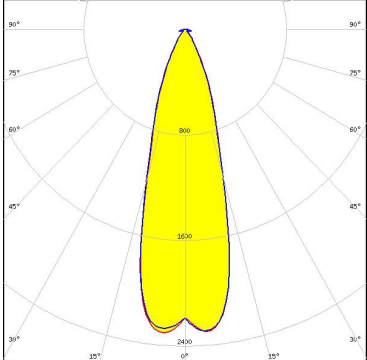
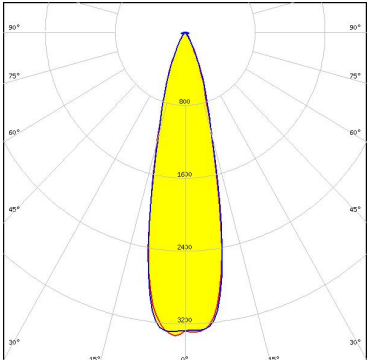
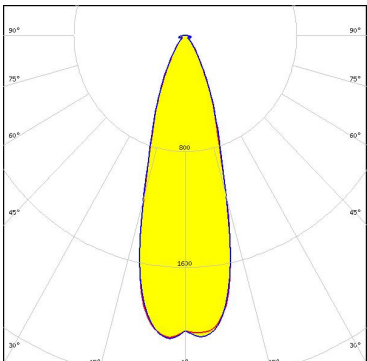
<p>CREE LEDs</p> <p>LED: CMA3090 FWHM / FWTM: 30.0° / 60.0° Efficiency: 94 % Peak intensity: 2.4 cd/lm LEDs/each optic: 1 Light colour: White Required components:</p>	
<p>CREE LEDs</p> <p>LED: CMU22xx FWHM / FWTM: 30.0° / 59.0° Efficiency: 95 % Peak intensity: 2.4 cd/lm LEDs/each optic: 1 Light colour: White Required components: Bender Wirth: 431 Typ L4</p>	
<p>CREE LEDs</p> <p>LED: CXA/B 25xx FWHM / FWTM: 25.0° / 50.0° Efficiency: 94 % Peak intensity: 3.4 cd/lm LEDs/each optic: 1 Light colour: White Required components:</p>	
<p>LUMILEDS</p> <p>LED: LUXEON CoB 1213/1216/1812 FWHM / FWTM: 31.0° / 63.0° Efficiency: 94 % Peak intensity: 2.1 cd/lm LEDs/each optic: 1 Light colour: White Required components:</p>	

OPTICAL RESULTS (SIMULATED):

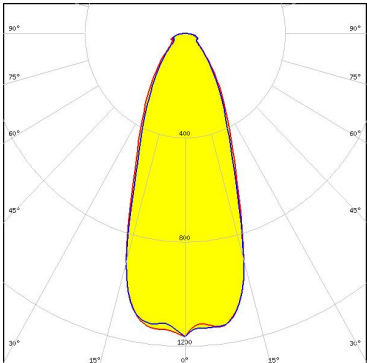
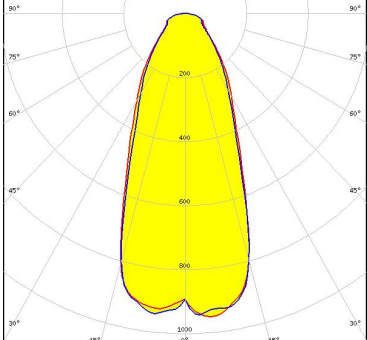
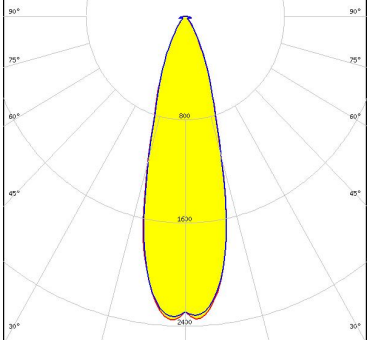
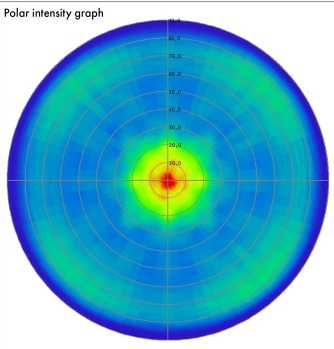
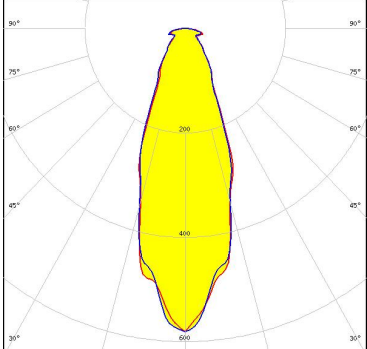
<p>LUMILEDS</p> <p>LED LUXEON CoB 1321</p> <p>FWHM / FWTM 41.0° / 89.0°</p> <p>Efficiency 94 %</p> <p>Peak intensity 1.2 cd/lm</p> <p>LEDs/each optic 1</p> <p>Light colour White</p> <p>Required components:</p>	
<p>LUMILEDS</p> <p>LED LUXEON CoB 1825</p> <p>FWHM / FWTM 44.1° / 102.3°</p> <p>Efficiency 94 %</p> <p>Peak intensity 0.9 cd/lm</p> <p>LEDs/each optic 1</p> <p>Light colour White</p> <p>Required components:</p>	
<p>LUMINUS</p> <p>LED CxM-22 (28x28)</p> <p>FWHM / FWTM 30.0° / 60.0°</p> <p>Efficiency 95 %</p> <p>Peak intensity 2.4 cd/lm</p> <p>LEDs/each optic 1</p> <p>Light colour White</p> <p>Required components: Bender Wirth: 431 Typ L4</p>	
<p>LUMINUS</p> <p>LED XFM-5050 3 Die</p> <p>FWHM / FWTM 40.0° / 164.0°</p> <p>Efficiency 42 %</p> <p>LEDs/each optic 21</p> <p>Light colour UV-C</p> <p>Required components:</p> <p>The UVC LED result tolerance is ±10 %</p>	<p>Polar intensity graph</p>  

OPTICAL RESULTS (SIMULATED):

PHILIPS

LED Fortimo SLM L13 CoB
 FWHM / FWTM 18.0° / 40.0°
 Efficiency 85 %
 Peak intensity 5.4 cd/lm
 LEDs/each optic 1
 Light colour White
 Required components:

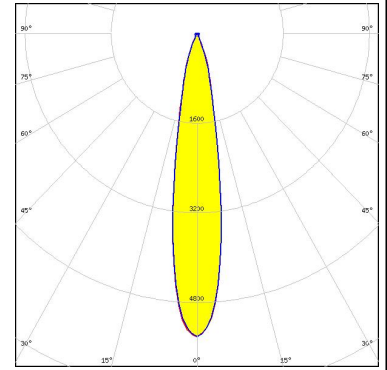

PHILIPS

LED Fortimo SLM L19 CoB
 FWHM / FWTM 26.0° / 52.0°
 Efficiency 85 %
 Peak intensity 2.9 cd/lm
 LEDs/each optic 1
 Light colour White
 Required components:

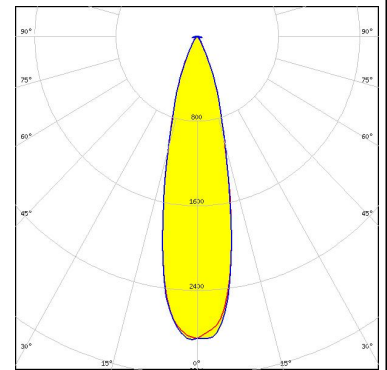

PHILIPS

LED Fortimo SLM L23 CoB
 FWHM / FWTM 30.0° / 59.0°
 Efficiency 85 %
 Peak intensity 2.1 cd/lm
 LEDs/each optic 1
 Light colour White
 Required components:

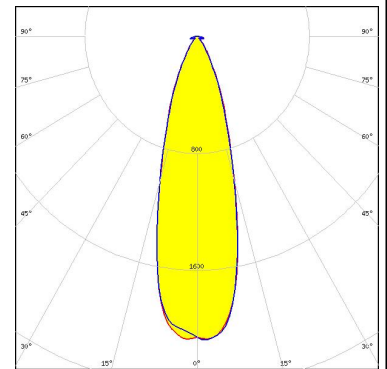

GENERAL INFORMATION:

NOTE: The typical beam angle will be changed by different color, chip size and chip position tolerance. The typical total beam angle is the full angle measured where the luminous intensity is half of the peak value.

Due to use of high power COB's with this product, special attention to proper thermal design is highly recommended. LEDiL has no liability for direct, indirect or consecutive damages arising from the LEDiL products being used outside of the recommended temperature range.

MATERIALS:

As part of our continuous research and improvement processes, and to ensure the best possible quality and availability of our products, LEDiL reserves the right to change material grades without notice.

PRODUCT DATA USER AGREEMENT AND DISCLAIMER:

The measured data in the provided downloadable LEDiL Product Datasheets and Mechanical 2D-Drawings is rounded and provided as reference for planning. LEDiL Oy's optical specifications have been verified by conducting performance testing of the products in accordance with the company's quality system. The reported data are averaged results of multiple measurements with typical variation. LEDiL Oy reserves the right to without prior notification make changes and improvements to its products.

LEDiL Oy assumes neither warranty, nor guarantee nor any other liability of any kind for the contents and correctness of the provided data. The provided data has been generated with highest diligence but the provided data may in reality not represent the complete possible variation range of all intrinsic parameters. Therefore, in certain cases a deviation from the provided data could occur.

LEDiL Oy reserves the right to undertake technical changes of its products without further notification which could lead to changes in the provided data. LEDiL Oy assumes no liability of any kind for the possible deviation from any provided data or any other damage resulting from the usage of the provided data.

The user agrees to this disclaimer and user agreement with the download or usage of the provided files.

LEDiL Oy

Joensuunkatu 13
FI-24240 SALO
Finland

LEDiL Inc.

228 West Page Street
Suite D
Sycamore IL 60178
USA

Ledil Optics Technology (Shenzhen) Co., Ltd.

405 , Block B
Casic Motor Building
Shenzhen 518057
P.R.CHINA

Local sales and technical support

[www.ledil.com/
where_to_buy](http://www.ledil.com/where_to_buy)

Shipping locations

Salo, Finland
Hong Kong, China

Distribution Partners

[www.ledil.com/
where_to_buy](http://www.ledil.com/where_to_buy)