

OLGA-W

~40° wide beam with flange. Assembly with holder and installation tape.

SPECIFICATION:

Dimensions	Ø 32.0 mm
Height	19.1 mm
Fastening	tape, pin
ROHS compliant	yes ⓘ



MATERIALS:

Component	Type	Material	Colour	Finish
OLGA-W	Single lens	PMMA	clear	
OLGA-HLD	Holder	PC	black	
SPUTNIK-TAPE3	Tape	Acrylic foam	black	



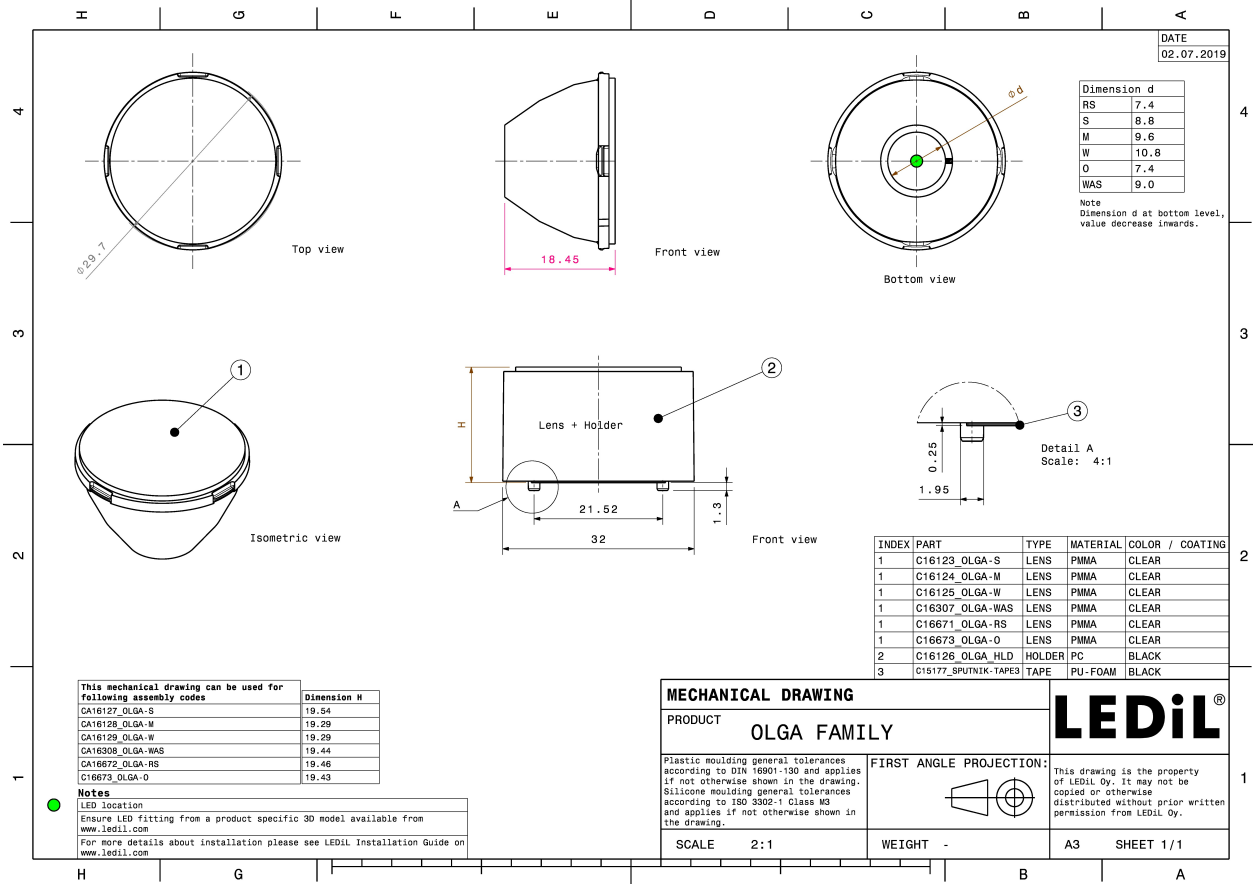

ORDERING INFORMATION:

Component		Qty in box	MOQ	MPQ	Box weight (kg)
CA16129_OLGA-W	Single lens	792	132	66	10.0
» Box size: 476 x 273 x 292 mm					

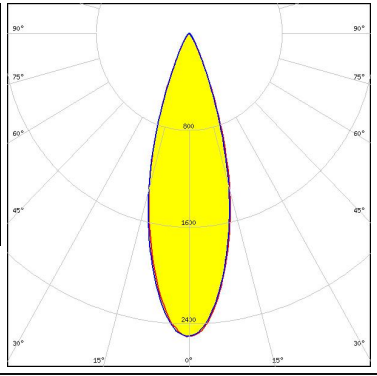

See also our general installation guide: www.ledil.com/installation_guide

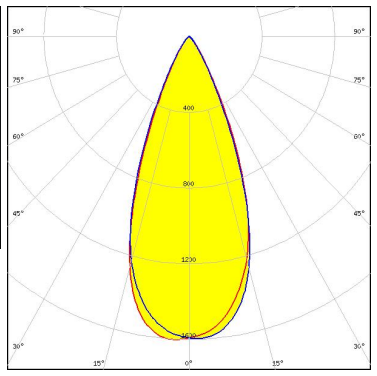

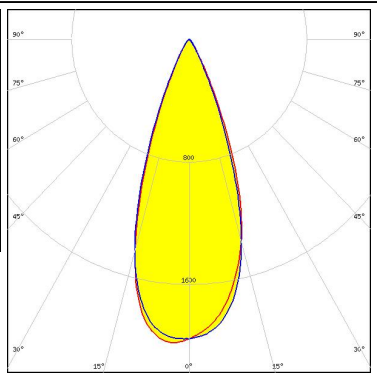
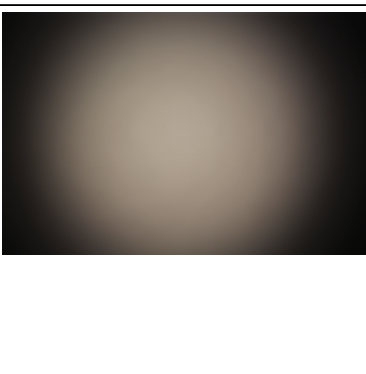
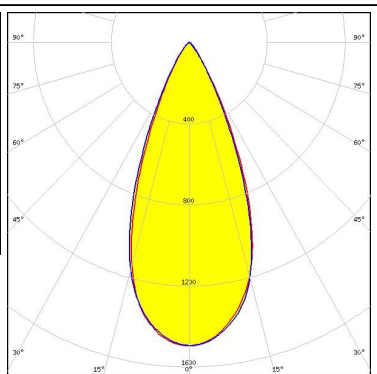

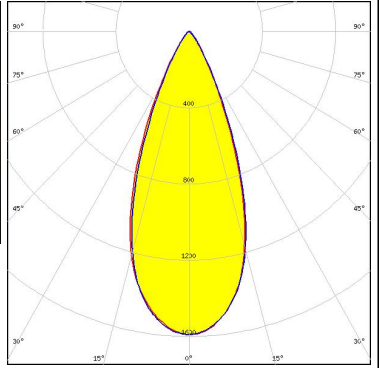
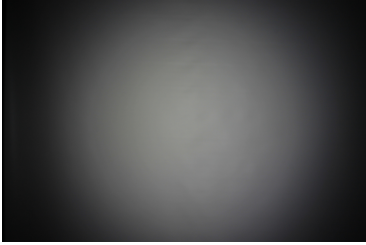
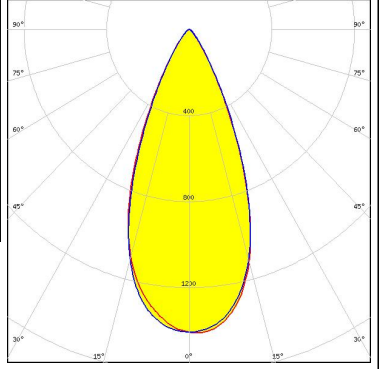
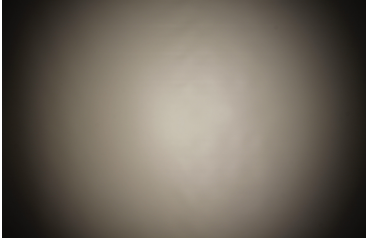
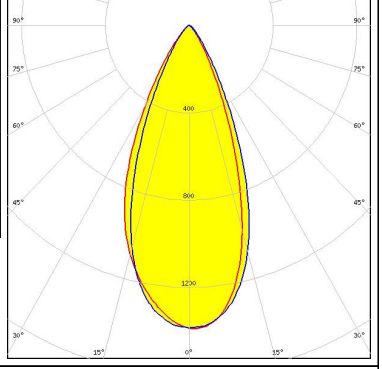
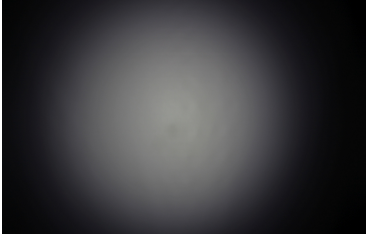
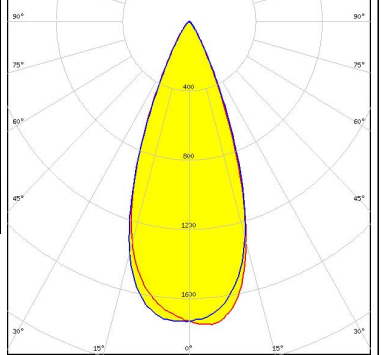

OPTICAL RESULTS (MEASURED):

<p>CREE LEDs</p> <p>LED XD16 FWHM / FWTM 32.0° / 54.0° Efficiency 82 % Peak intensity 2.5 cd/lm LEDs/each optic 1 Light colour White Required components:</p>		
<p>CREE LEDs</p> <p>LED XHP35 HD FWHM / FWTM 42.0° / 65.0° Efficiency 84 % Peak intensity 1.6 cd/lm LEDs/each optic 1 Light colour White Required components:</p>		
<p>CREE LEDs</p> <p>LED XHP35 HI FWHM / FWTM 38.0° / 58.0° Efficiency 85 % Peak intensity 2 cd/lm LEDs/each optic 1 Light colour White Required components:</p>		
<p>CREE LEDs</p> <p>LED XHP50 FWHM / FWTM 43.0° / 68.0° Efficiency 84 % Peak intensity 1.5 cd/lm LEDs/each optic 1 Light colour White Required components:</p>		

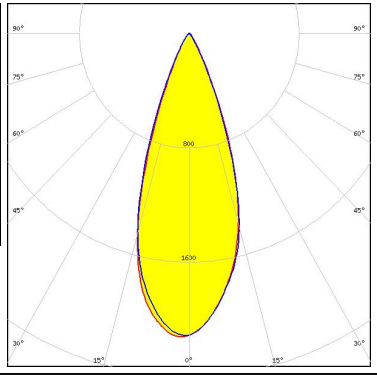

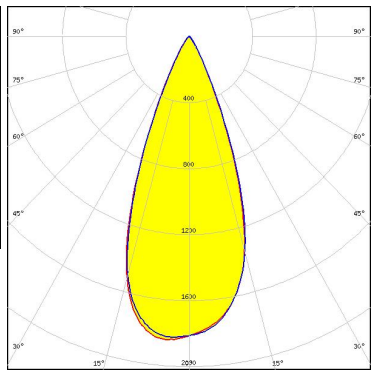

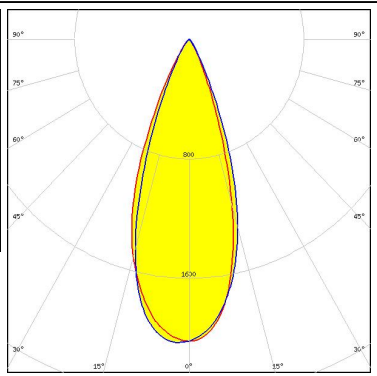

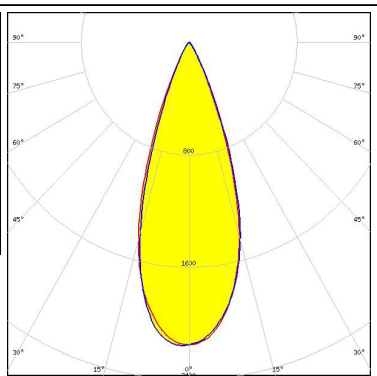
OPTICAL RESULTS (MEASURED):

<p>CREE LEDs</p> <p>LED XHP50.2 FWHM / FWTM 42.0° / 66.0° Efficiency 84 % Peak intensity 1.6 cd/lm LEDs/each optic 1 Light colour White Required components:</p>		
<p>CREE LEDs</p> <p>LED XHP70 FWHM / FWTM 44.0° / 70.0° Efficiency 84 % Peak intensity 1.4 cd/lm LEDs/each optic 1 Light colour White Required components:</p>		
<p>CREE LEDs</p> <p>LED XHP70.2 FWHM / FWTM 44.0° / 71.0° Efficiency 83 % Peak intensity 1.4 cd/lm LEDs/each optic 1 Light colour White Required components:</p>		
<p>CREE LEDs</p> <p>LED XM-L3 FWHM / FWTM 40.0° / 62.0° Efficiency 85 % Peak intensity 1.8 cd/lm LEDs/each optic 1 Light colour White Required components:</p>		

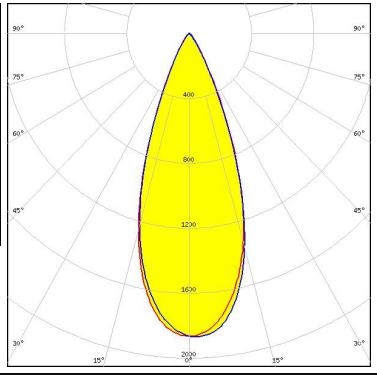

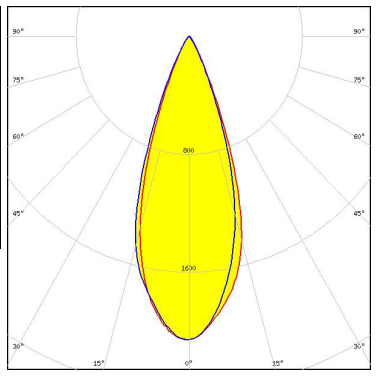
OPTICAL RESULTS (MEASURED):

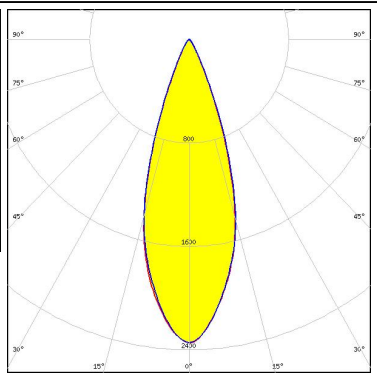
<p>CREE LEDs</p> <p>LED XP-E2 FWHM / FWTM 37.0° / 57.0° Efficiency 86 % Peak intensity 2.1 cd/lm LEDs/each optic 1 Light colour White Required components:</p>		
<p>CREE LEDs</p> <p>LED XP-G2 FWHM / FWTM 41.0° / 60.0° Efficiency 86 % Peak intensity 1.8 cd/lm LEDs/each optic 1 Light colour White Required components:</p>		
<p>CREE LEDs</p> <p>LED XP-G3 FWHM / FWTM 37.0° / 59.0° Efficiency 85 % Peak intensity 2 cd/lm LEDs/each optic 1 Light colour White Required components:</p>		
<p>CREE LEDs</p> <p>LED XP-L HI FWHM / FWTM 37.0° / 56.0° Efficiency 86 % Peak intensity 2.2 cd/lm LEDs/each optic 1 Light colour White Required components:</p>		

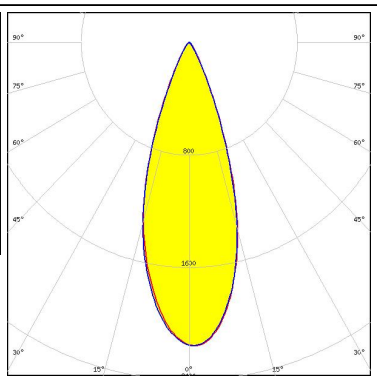
OPTICAL RESULTS (MEASURED):

<p>CREE LEDs</p> <p>LED XP-L2 FWHM / FWTM 39.0° / 61.0° Efficiency 84 % Peak intensity 1.8 cd/m LEDs/each optic 1 Light colour White Required components:</p>		
<p>CREE LEDs</p> <p>LED XQ-E HD FWHM / FWTM 37.0° / 57.0° Efficiency 81 % Peak intensity 2.1 cd/m LEDs/each optic 1 Light colour White Required components:</p>		
<p>CREE LEDs</p> <p>LED XQ-E HI FWHM / FWTM 34.0° / 54.0° Efficiency 85 % Peak intensity 2.3 cd/m LEDs/each optic 1 Light colour White Required components:</p>		
<p>CREE LEDs</p> <p>LED XT-E FWHM / FWTM 35.0° / 57.0° Efficiency 84 % Peak intensity 2.2 cd/m LEDs/each optic 1 Light colour White Required components:</p>		

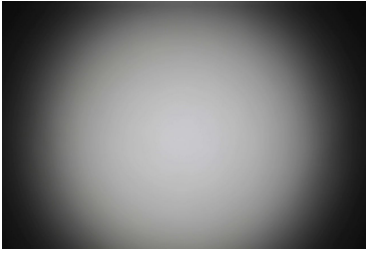
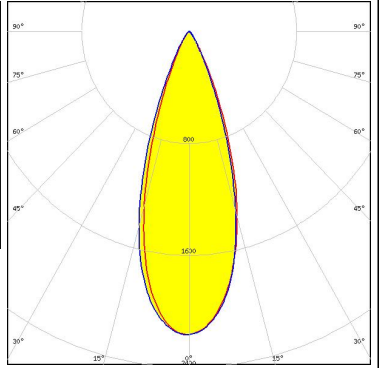
OPTICAL RESULTS (MEASURED):

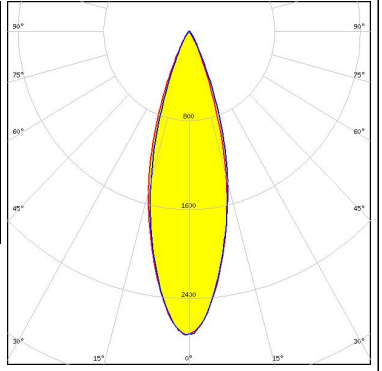
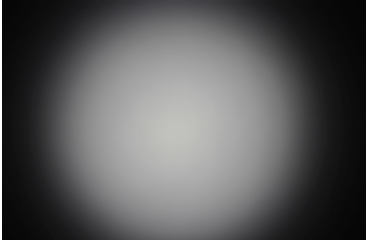
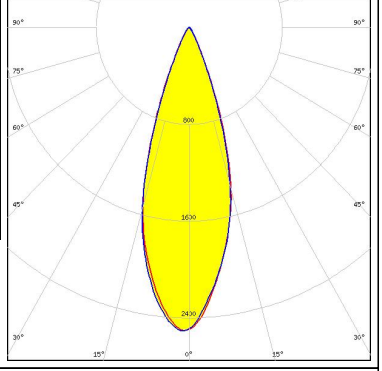
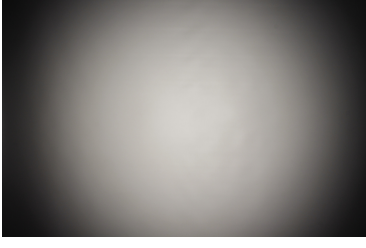
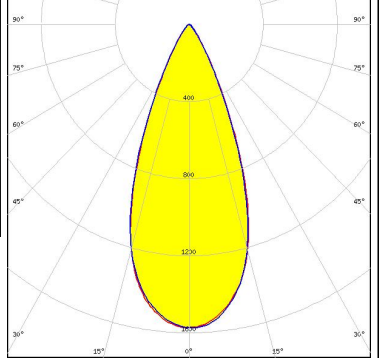
<p>LUMILEDS</p> <p>LED LUXEON 5050 Round LES</p> <p>FWHM / FWTM 35.0° / 58.0°</p> <p>Efficiency 86 %</p> <p>Peak intensity 2.2 cd/m</p> <p>LEDs/each optic 1</p> <p>Light colour White</p> <p>Required components:</p>		
<p>LUMILEDS</p> <p>LED LUXEON C</p> <p>FWHM / FWTM 31.0° / 53.0°</p> <p>Efficiency 84 %</p> <p>Peak intensity 2.7 cd/m</p> <p>LEDs/each optic 1</p> <p>Light colour White</p> <p>Required components:</p>		
<p>LUMILEDS</p> <p>LED LUXEON CZ</p> <p>FWHM / FWTM 34.0° / 53.0°</p> <p>Efficiency 86 %</p> <p>Peak intensity 2.5 cd/m</p> <p>LEDs/each optic 1</p> <p>Light colour White</p> <p>Required components:</p>		
<p>LUMILEDS</p> <p>LED LUXEON M/MX</p> <p>FWHM / FWTM 42.0° / 66.0°</p> <p>Efficiency 84 %</p> <p>Peak intensity 1.6 cd/m</p> <p>LEDs/each optic 1</p> <p>Light colour White</p> <p>Required components:</p>		

OPTICAL RESULTS (MEASURED):

LUMILEDS

LED LUXEON MZ
 FWHM / FWTM 34.0° / 56.0°
 Efficiency 86 %
 Peak intensity 2.4 cd/lm
 LEDs/each optic 1
 Light colour White
 Required components:

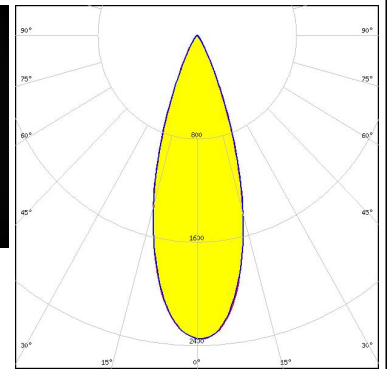
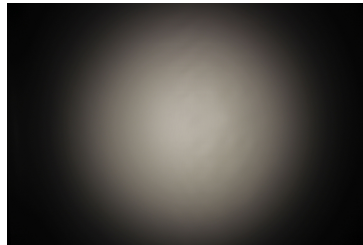

LUMILEDS

LED LUXEON Rebel ES
 FWHM / FWTM 37.0° / 58.0°
 Efficiency 85 %
 Peak intensity 2.1 cd/lm
 LEDs/each optic 1
 Light colour White
 Required components:

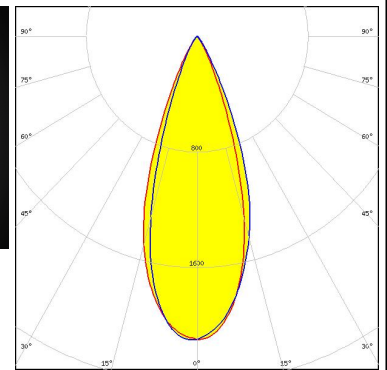
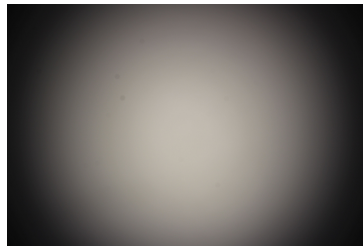

LUMILEDS

LED LUXEON TX
 FWHM / FWTM 36.0° / 57.0°
 Efficiency 85 %
 Peak intensity 2.2 cd/lm
 LEDs/each optic 1
 Light colour White
 Required components:

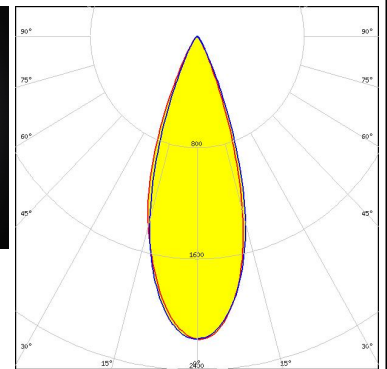
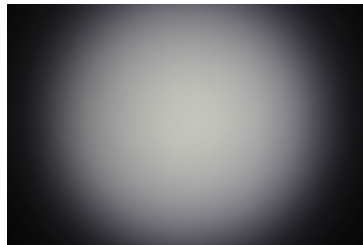

LUMILEDS

LED LUXEON V
 FWHM / FWTM 38.0° / 60.0°
 Efficiency 84 %
 Peak intensity 2 cd/lm
 LEDs/each optic 1
 Light colour White
 Required components:

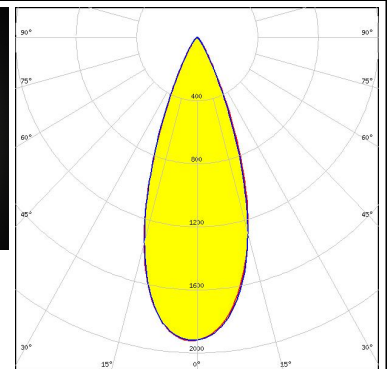
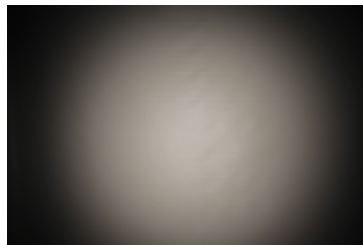

OPTICAL RESULTS (MEASURED):

LUMILEDS

LED LUXEON V2
 FWHM / FWTM 37.0° / 57.0°
 Efficiency 85 %
 Peak intensity 2.1 cd/m
 LEDs/each optic 1
 Light colour White
 Required components:

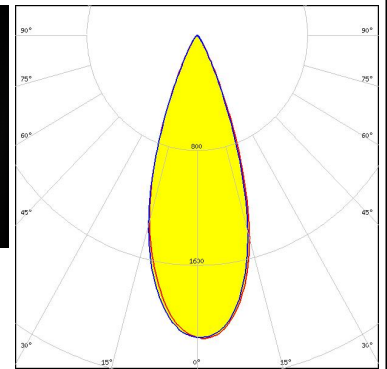
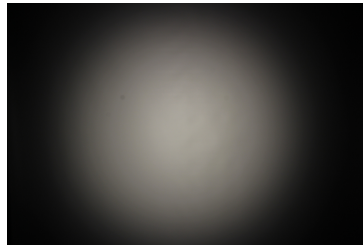

LUMILEDS

LED LUXEON Z
 FWHM / FWTM 32.0° / 52.0°
 Efficiency 85 %
 Peak intensity 2.7 cd/m
 LEDs/each optic 1
 Light colour White
 Required components:

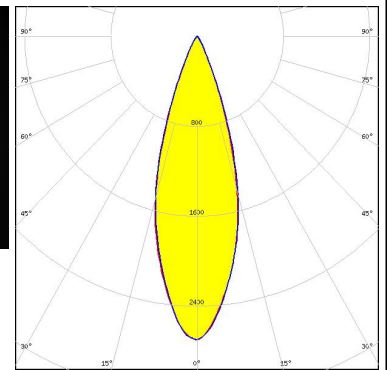
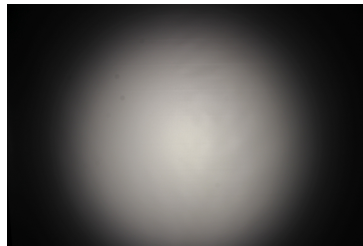

LUMILEDS

LED LUXEON Z ES
 FWHM / FWTM 35.0° / 54.0°
 Efficiency 86 %
 Peak intensity 2.4 cd/m
 LEDs/each optic 1
 Light colour White
 Required components:

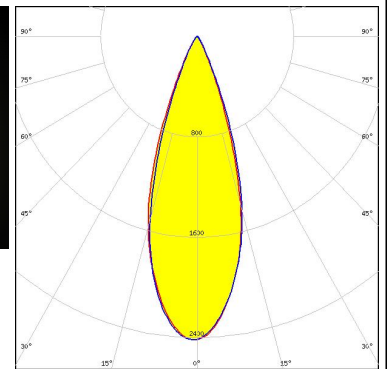
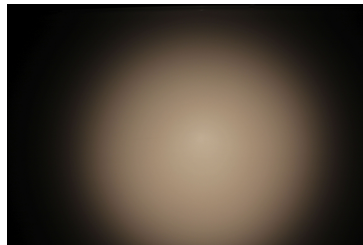

NICHIA

LED NCSxE17A
 FWHM / FWTM 28.0° / 50.0°
 Efficiency 86 %
 Peak intensity 3.1 cd/m
 LEDs/each optic 1
 Light colour White
 Required components:

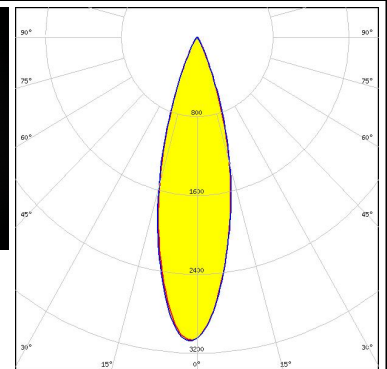
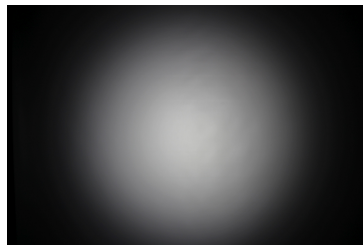

OPTICAL RESULTS (MEASURED):

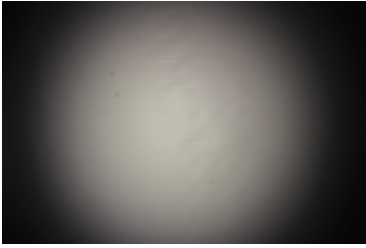
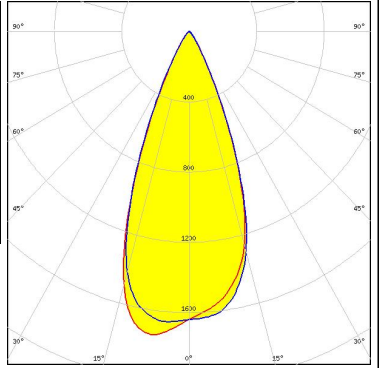
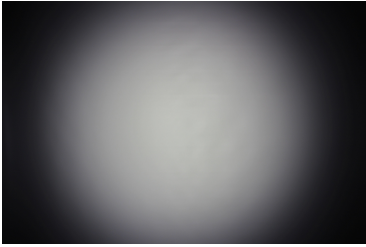
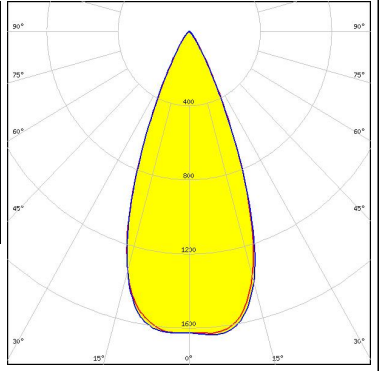
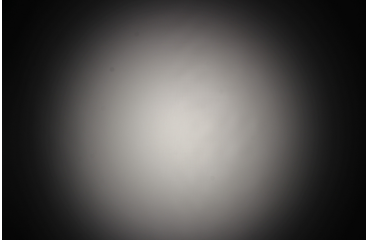
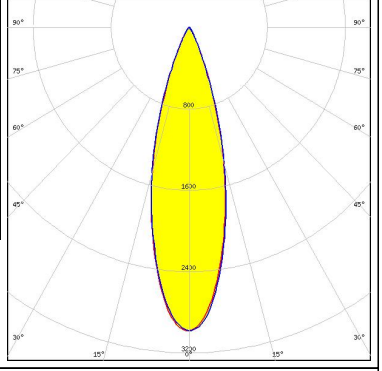
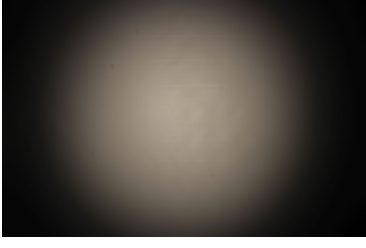
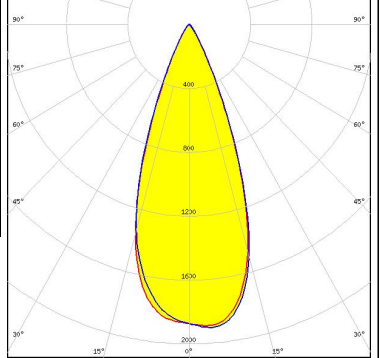
<p>NICHIA</p> <p>LED NVSW219F FWHM / FWTM 42.0° / 62.0° Efficiency 85 % Peak intensity 1.7 cd/lm LEDs/each optic 1 Light colour White Required components:</p>		
<p>NICHIA</p> <p>LED NVSW319B FWHM / FWTM 43.0° / 63.0° Efficiency 86 % Peak intensity 1.6 cd/lm LEDs/each optic 1 Light colour White Required components:</p>		
<p>NICHIA</p> <p>LED NVSxE21A FWHM / FWTM 29.0° / 51.0° Efficiency 86 % Peak intensity 3 cd/lm LEDs/each optic 1 Light colour White Required components:</p>		
<p>NICHIA</p> <p>LED NVSxx19B/NVSxx19C FWHM / FWTM 39.0° / 60.0° Efficiency 85 % Peak intensity 1.9 cd/lm LEDs/each optic 1 Light colour White Required components:</p>		

OPTICAL RESULTS (MEASURED):

OSRAM

Opto Semiconductors

LED OSCONIQ P 3737 (2W version)
 FWHM / FWTM 35.0° / 56.0°
 Efficiency 86 %
 Peak intensity 2.3 cd/lm
 LEDs/each optic 1
 Light colour White
 Required components:

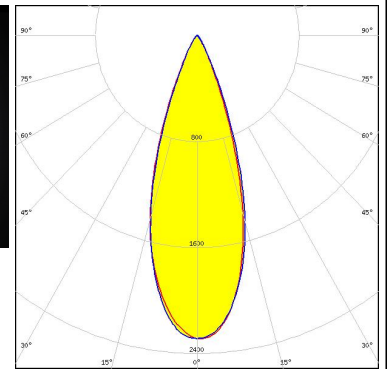
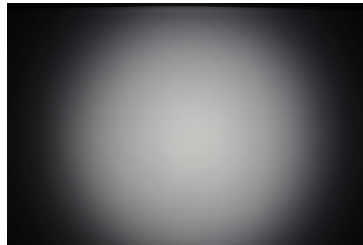

OSRAM

Opto Semiconductors

LED OSCONIQ P 3737 (3W version)
 FWHM / FWTM 38.0° / 59.0°
 Efficiency 86 %
 Peak intensity 2 cd/lm
 LEDs/each optic 1
 Light colour White
 Required components:

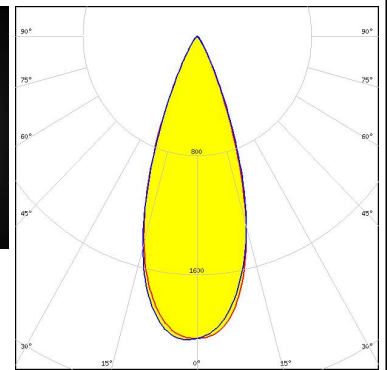
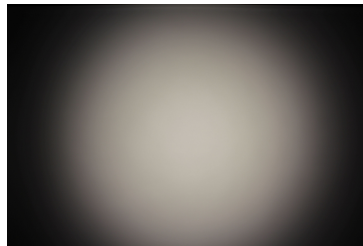

OSRAM

Opto Semiconductors

LED OSCONIQ P 7070
 FWHM / FWTM 39.0° / 62.0°
 Efficiency 85 %
 Peak intensity 1.8 cd/lm
 LEDs/each optic 1
 Light colour White
 Required components:

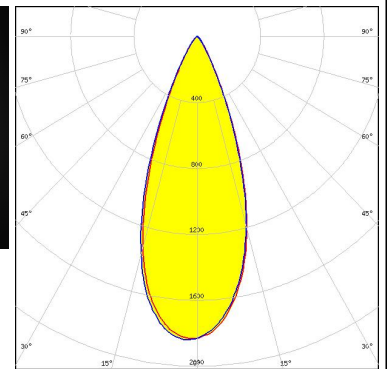
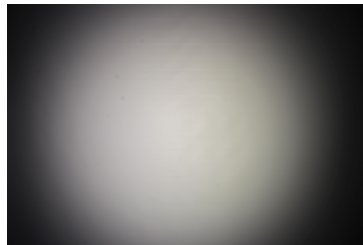

OSRAM

Opto Semiconductors

LED OSLON Black Flat (LUW HWQP)
 FWHM / FWTM 31.0° / 51.0°
 Efficiency 85 %
 Peak intensity 2.8 cd/lm
 LEDs/each optic 1
 Light colour White
 Required components:

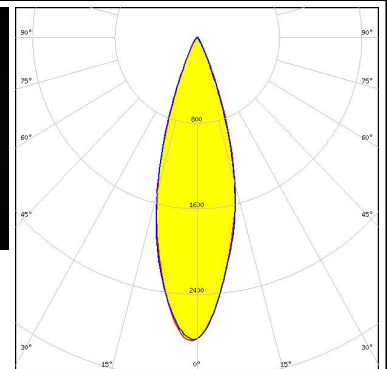
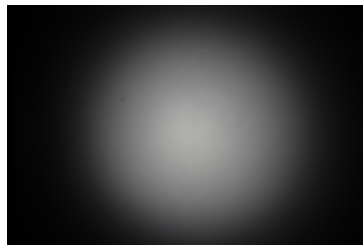

OPTICAL RESULTS (MEASURED):

OSRAM

Opto Semiconductors

LED OSLON Square CSSRM2/CSSRM3
 FWHM / FWTM 39.0° / 59.0°
 Efficiency 85 %
 Peak intensity 2 cd/lm
 LEDs/each optic 1
 Light colour White
 Required components:

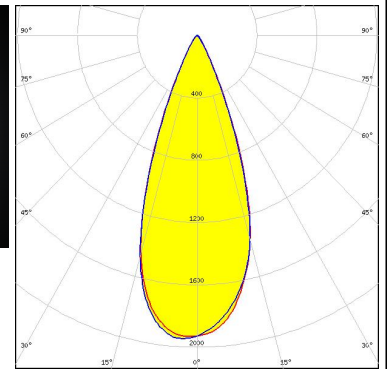
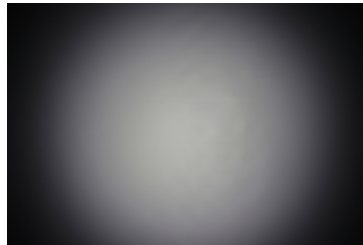

OSRAM

Opto Semiconductors

LED OSLON Square EC
 FWHM / FWTM 39.0° / 59.0°
 Efficiency 84 %
 Peak intensity 1.9 cd/lm
 LEDs/each optic 1
 Light colour White
 Required components:

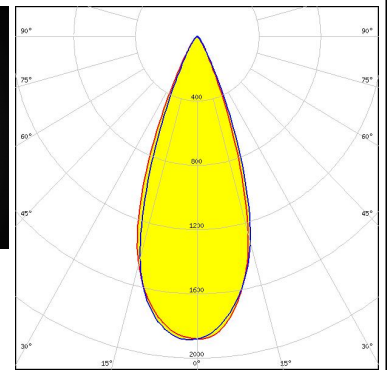
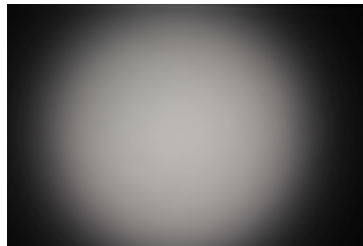

OSRAM

Opto Semiconductors

LED OSLON Square PC
 FWHM / FWTM 39.0° / 60.0°
 Efficiency 85 %
 Peak intensity 1.9 cd/lm
 LEDs/each optic 1
 Light colour White
 Required components:

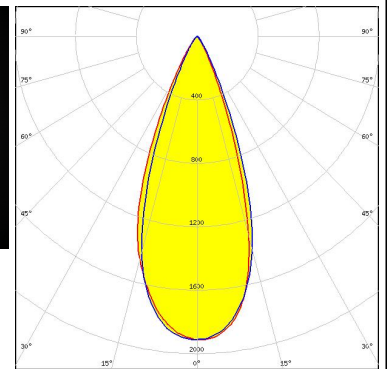
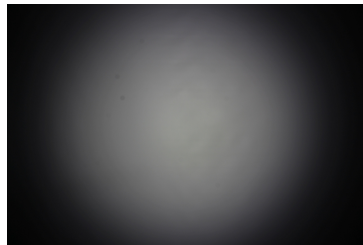

OSRAM

Opto Semiconductors

LED OSLON SSL 150
 FWHM / FWTM 34.0° / 54.0°
 Efficiency 85 %
 Peak intensity 2.5 cd/lm
 LEDs/each optic 1
 Light colour White
 Required components:

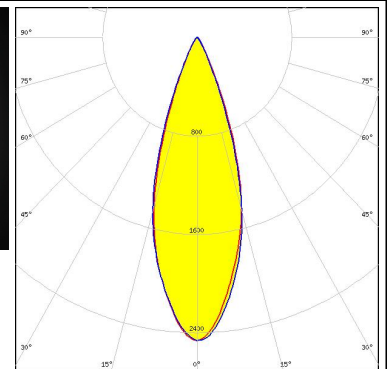
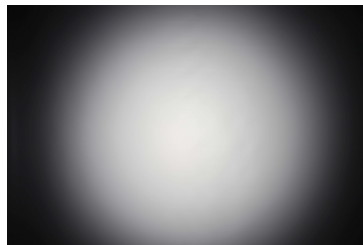

OPTICAL RESULTS (MEASURED):

OSRAM

Opto Semiconductors

LED OSLON SSL 80
 FWHM / FWTM 38.0° / 58.0°
 Efficiency 85 %
 Peak intensity 2 cd/lm
 LEDs/each optic 1
 Light colour White
 Required components:

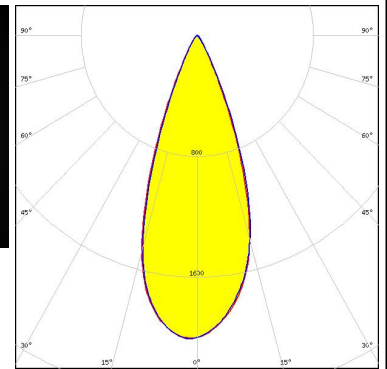
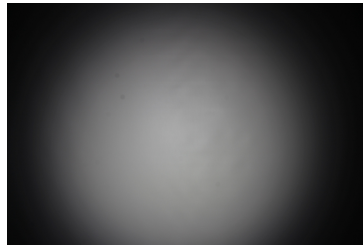

OSRAM

Opto Semiconductors

LED OSTAR Stage (S2WN)
 FWHM / FWTM 38.0° / 59.0°
 Efficiency 85 %
 Peak intensity 2.1 cd/lm
 LEDs/each optic 1
 Light colour RGBW
 Required components:

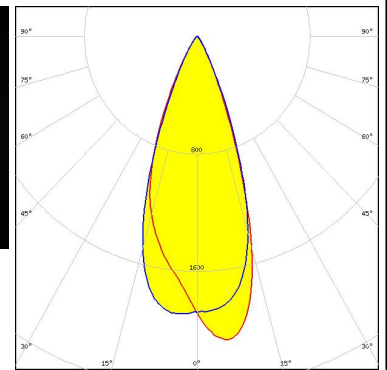
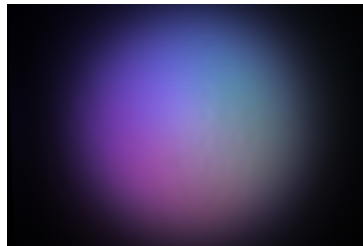

SAMSUNG

LED LH181A
 FWHM / FWTM 28.0° / 51.0°
 Efficiency 82 %
 Peak intensity 2.8 cd/lm
 LEDs/each optic 1
 Light colour White
 Required components:

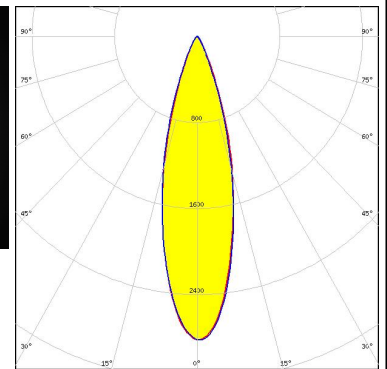
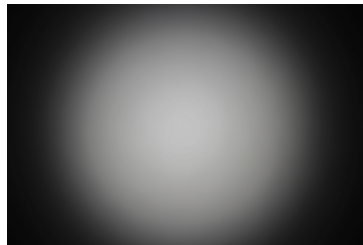

SAMSUNG

LED LH181B
 FWHM / FWTM 30.0° / 51.0°
 Efficiency 85 %
 Peak intensity 2.8 cd/lm
 LEDs/each optic 1
 Light colour White
 Required components:

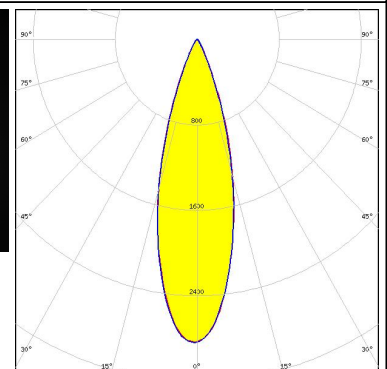
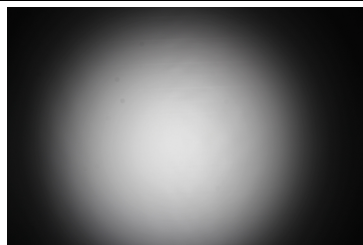

OPTICAL RESULTS (MEASURED):

SAMSUNG

LED LH231B
 FWHM / FWTM 31.0° / 53.0°
 Efficiency 86 %
 Peak intensity 2.7 cd/m
 LEDs/each optic 1
 Light colour White
 Required components:

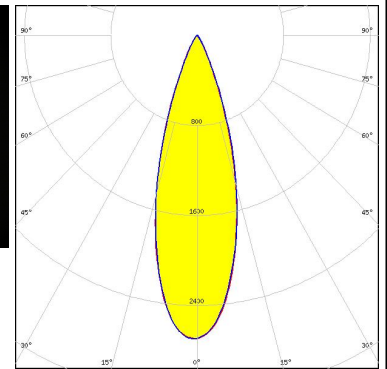
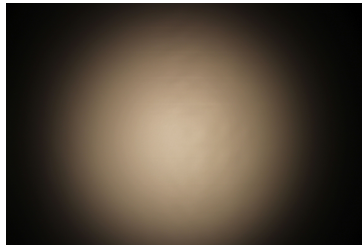

SAMSUNG

LED LH351B
 FWHM / FWTM 41.0° / 61.0°
 Efficiency 85 %
 Peak intensity 1.8 cd/m
 LEDs/each optic 1
 Light colour White
 Required components:

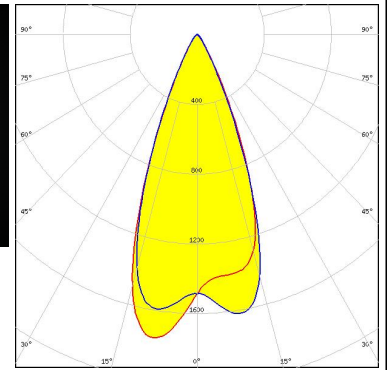

SAMSUNG

LED LH351C
 FWHM / FWTM 43.0° / 62.0°
 Efficiency 86 %
 Peak intensity 1.7 cd/m
 LEDs/each optic 1
 Light colour White
 Required components:

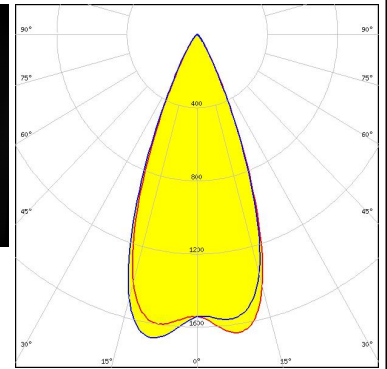
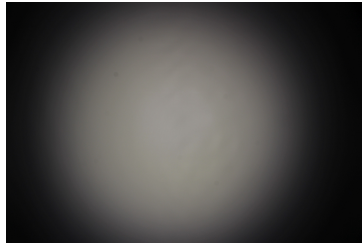

SAMSUNG

LED LH351D
 FWHM / FWTM 44.0° / 65.0°
 Efficiency 85 %
 Peak intensity 1.6 cd/m
 LEDs/each optic 1
 Light colour White
 Required components:

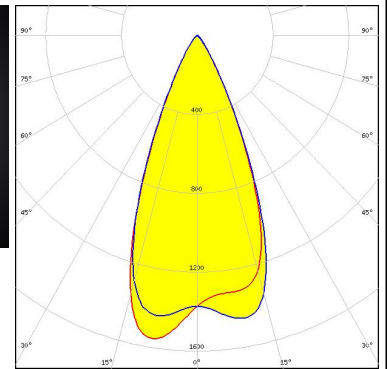
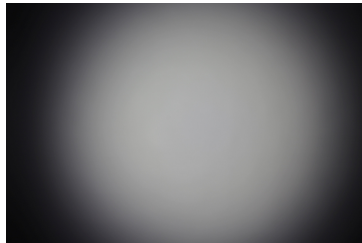

OPTICAL RESULTS (MEASURED):

SAMSUNG

LED LH508A
 FWHM / FWTM 36.0° / 58.0°
 Efficiency 86 %
 Peak intensity 2.2 cd/lm
 LEDs/each optic 1
 Light colour White
 Required components:

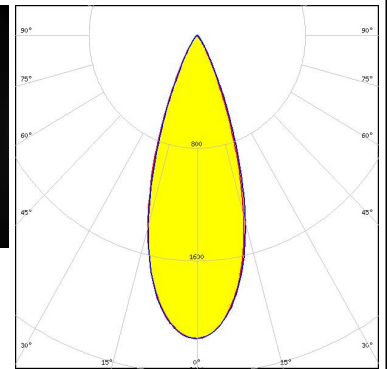
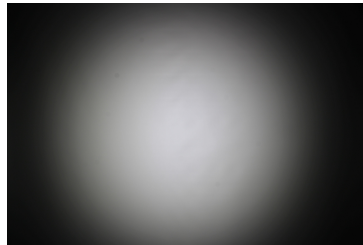

SAMSUNG

LED LM561B
 FWHM / FWTM 36.0° / 57.0°
 Efficiency 86 %
 Peak intensity 2.3 cd/lm
 LEDs/each optic 1
 Light colour White
 Required components:

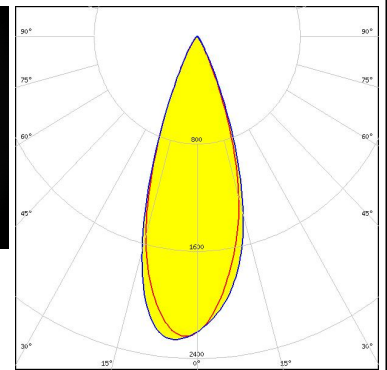
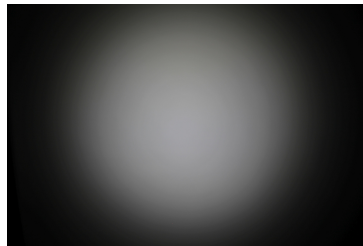

SEOUL SEMICONDUCTOR

LED WICOP 5050
 FWHM / FWTM 42.0° / 67.0°
 Efficiency 83 %
 Peak intensity 1.6 cd/lm
 LEDs/each optic 1
 Light colour White
 Required components:

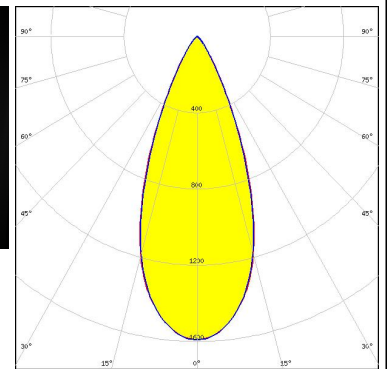
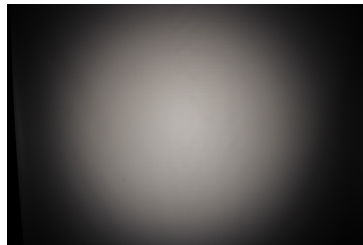

SEOUL SEMICONDUCTOR

LED Z5M3
 FWHM / FWTM 36.0° / 58.0°
 Efficiency 85 %
 Peak intensity 2.2 cd/lm
 LEDs/each optic 1
 Light colour White
 Required components:

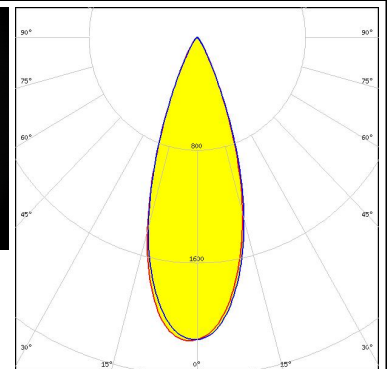
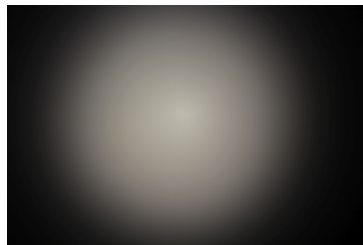

OPTICAL RESULTS (SIMULATED):



LED J Series 5050 Round LES
 FWHM / FWTM 40.0° / 56.0°
 Efficiency 94 %
 Peak intensity 2.3 cd/lm
 LEDs/each optic 1
 Light colour White
 Required components:

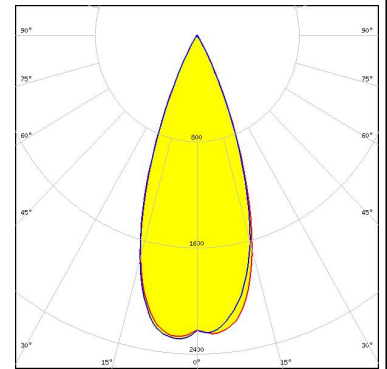

LED XHP50.3 HD
 FWHM / FWTM 44.0° / 62.0°
 Efficiency 84 %
 Peak intensity 1.6 cd/lm
 LEDs/each optic 1
 Light colour White
 Required components:

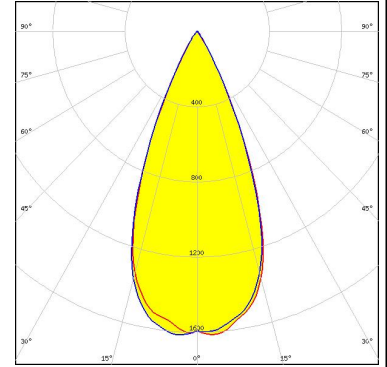

LED XHP50.3 HI
 FWHM / FWTM 40.0° / 58.0°
 Efficiency 95 %
 Peak intensity 2.1 cd/lm
 LEDs/each optic 1
 Light colour White
 Required components:

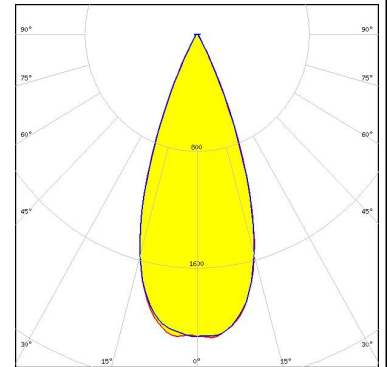

LED XHP70.3 HD
 FWHM / FWTM 46.0° / 66.0°
 Efficiency 83 %
 Peak intensity 1.5 cd/lm
 LEDs/each optic 1
 Light colour White
 Required components:

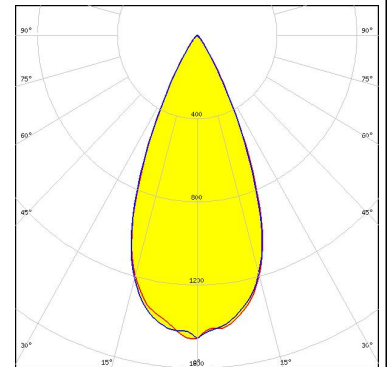

OPTICAL RESULTS (SIMULATED):



LED XM-L
 FWHM / FWTM 45.0° / 60.0°
 Efficiency 93 %
 Peak intensity 1.9 cd/lm
 LEDs/each optic 1
 Light colour White
 Required components:

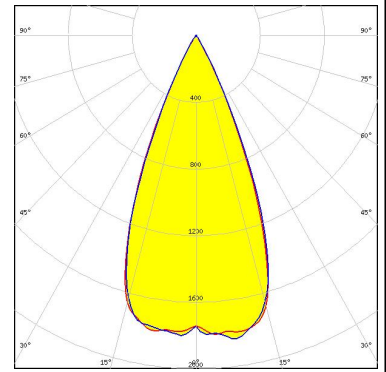

LED XM-L2
 FWHM / FWTM 43.0° / 58.0°
 Efficiency 93 %
 Peak intensity 2 cd/lm
 LEDs/each optic 1
 Light colour White
 Required components:

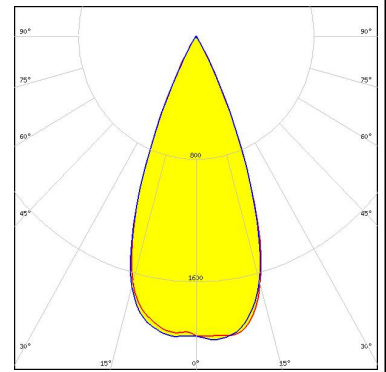

LED LUXEON 7070
 FWHM / FWTM 38.0° / 60.0°
 Efficiency 94 %
 Peak intensity 2.1 cd/lm
 LEDs/each optic 1
 Light colour White
 Required components:

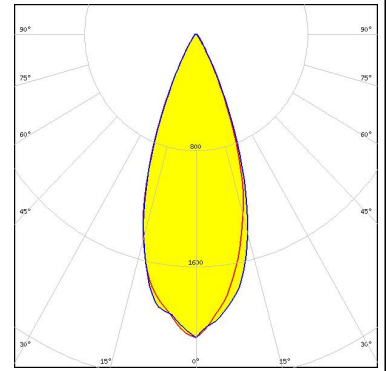

LED SST-20
 FWHM / FWTM 36.0° / 54.0°
 Efficiency 93 %
 Peak intensity 2.7 cd/lm
 LEDs/each optic 1
 Light colour White
 Required components:

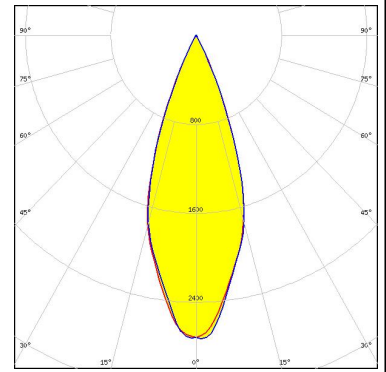

OPTICAL RESULTS (SIMULATED):

<p>LUMINUS</p> <p>LED SST-70X-WCS FWHM / FWTM 40.0° / 58.0° Efficiency 88 % Peak intensity 2.1 cd/lm LEDs/each optic 1 Light colour White Required components:</p>	
<p>NICHIA</p> <p>LED COB S-Type (LES 7) FWHM / FWTM 42.0° / 64.0° Efficiency 93 % Peak intensity 2 cd/lm LEDs/each optic 1 Light colour White Required components:</p>	
<p>NICHIA</p> <p>LED COB T-Type FWHM / FWTM 40.0° / 62.0° Efficiency 93 % Peak intensity 2.1 cd/lm LEDs/each optic 1 Light colour White Required components:</p>	
<p>NICHIA</p> <p>LED NCSxE17A FWHM / FWTM 34.0° / 54.0° Efficiency 90 % Peak intensity 2.6 cd/lm LEDs/each optic 4 Light colour White Required components:</p>	

OPTICAL RESULTS (SIMULATED):

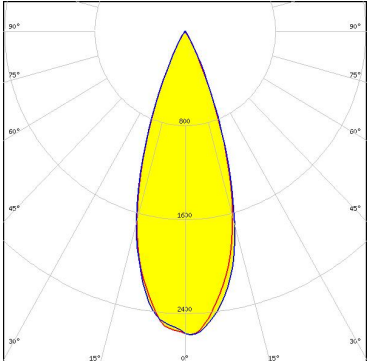
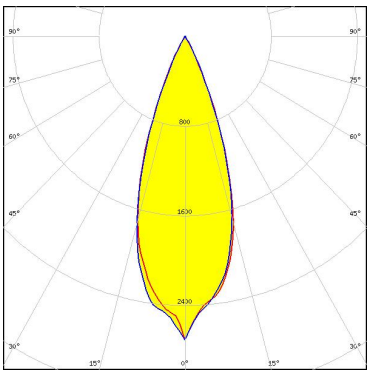
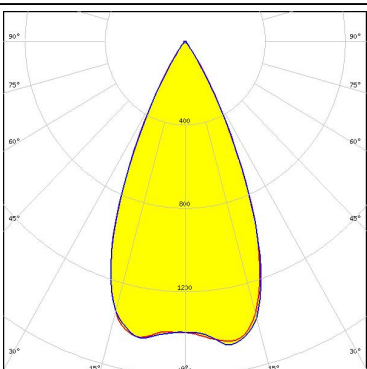
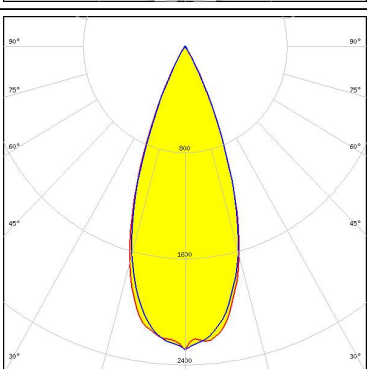
<p>NICHIA</p> <p>LED: NFMW48xA FWHM / FWTM: 36.0° / 55.0° Efficiency: 93 % Peak intensity: 2.6 cd/lm LEDs/each optic: 1 Light colour: White Required components:</p>	
<p>NICHIA</p> <p>LED: NV4WB35AM FWHM / FWTM: 36.0° / 54.0° Efficiency: 94 % Peak intensity: 2.7 cd/lm LEDs/each optic: 1 Light colour: White Required components:</p>	
<p>NICHIA</p> <p>LED: NV4x144A FWHM / FWTM: 48.0° / 66.0° Efficiency: 90 % Peak intensity: 1.5 cd/lm LEDs/each optic: 1 Light colour: White Required components:</p>	
<p>OSRAM <small>Opto Semiconductors</small></p> <p>LED: Duris S8 FWHM / FWTM: 39.0° / 58.0° Efficiency: 94 % Peak intensity: 2.3 cd/lm LEDs/each optic: 1 Light colour: White Required components:</p>	

GENERAL INFORMATION:

NOTE: The typical beam angle will be changed by different color, chip size and chip position tolerance. The typical total beam angle is the full angle measured where the luminous intensity is half of the peak value.

Due to use of high power COB's with this product, special attention to proper thermal design is highly recommended. LEDiL has no liability for direct, indirect or consecutive damages arising from the LEDiL products being used outside of the recommended temperature range.

MATERIALS:

As part of our continuous research and improvement processes, and to ensure the best possible quality and availability of our products, LEDiL reserves the right to change material grades without notice.

PRODUCT DATA USER AGREEMENT AND DISCLAIMER:

The measured data in the provided downloadable LEDiL Product Datasheets and Mechanical 2D-Drawings is rounded and provided as reference for planning. LEDiL Oy's optical specifications have been verified by conducting performance testing of the products in accordance with the company's quality system. The reported data are averaged results of multiple measurements with typical variation. LEDiL Oy reserves the right to without prior notification make changes and improvements to its products.

LEDiL Oy assumes neither warranty, nor guarantee nor any other liability of any kind for the contents and correctness of the provided data. The provided data has been generated with highest diligence but the provided data may in reality not represent the complete possible variation range of all intrinsic parameters. Therefore, in certain cases a deviation from the provided data could occur.

LEDiL Oy reserves the right to undertake technical changes of its products without further notification which could lead to changes in the provided data. LEDiL Oy assumes no liability of any kind for the possible deviation from any provided data or any other damage resulting from the usage of the provided data.

The user agrees to this disclaimer and user agreement with the download or usage of the provided files.

LEDiL Oy

Joensuunkatu 13
FI-24240 SALO
Finland

LEDiL Inc.

228 West Page Street
Suite D
Sycamore IL 60178
USA

Ledil Optics Technology (Shenzhen) Co., Ltd.

405 , Block B
Casic Motor Building
Shenzhen 518057
P.R.CHINA

Local sales and technical support

[www.ledil.com/
where_to_buy](http://www.ledil.com/where_to_buy)

Shipping locations

Salo, Finland
Hong Kong, China

Distribution Partners

[www.ledil.com/
where_to_buy](http://www.ledil.com/where_to_buy)